

# VIBIA

Price list February 2024

HOLLAND €

# Please read carefully the following

## Terms of sale and delivery

### 1. PRICES

1.1. The given prices are the suggested retail prices without VAT.

1.2. The pricing do not include bulbs (LED lights including LED).

1.3. This price list supersedes all previous ones.

### 2. ORDERS

2.1. For purposes of faster processing all orders must be in writing and directed exclusively to Barcelona (e-mail: [customer.service@vibia.com](mailto:customer.service@vibia.com) order WEB [www.vibia.com](http://www.vibia.com)).

### 3. PAYMENT TERMS

3.1. General payment terms: Payment by wire transfer.

3.2. Please note that the payment deadlines are binding and unchangeable.

3.3. The company will require special payment conditions (TOTAL PAYMENT or ADVANCE PART-PAYMENT) for orders relating to products manufactured in their entirety or partially received directly from clients, such as the Match collection and other customised creations. This applies equally to project orders which due to their volume must be manufactured by request.

3.4. No payment delays for holidays or festivities will be accepted.

3.5. The DUE DATE is calculated in all circumstances from the date on which the invoice is issued and never from the shipping delivery date, nor from the date of receipt of the material.

3.6. The Buyer is not entitled to set counterclaims as long as these are not acknowledged in writing or legally established.

3.7. In case of delay in payment we reserve the right to calculate and apply interest for late payment. We reserve the right to assert further costs.

3.8. We reserve the right at any time not to accept orders or effect deliveries only against advance payment, when the buyer does not meet his payment commitments or meets them only partially.

### 4. CONDITIONS OF TRANSPORT

4.1. Our transport conditions are: Orders from € 500 net will be delivered carriage free. In the case of orders below the carriage prepaid threshold we apply 10% of the net value of the goods as carriage costs at least € 25

4.2. Each order will be inserted individually in our computerized inventory system. We will not accumulate orders to reach the minimum for carriage paid. Once an order has been processed it cannot be modified to reach the minimum for carriage paid since the calculation for shipping costs has already been made by our system and cannot be modified.

4.3. Whenever a Customer requires urgent

shipment, transport costs will be charged regardless of the amount of the order.

4.4. Vibia does not undertake domestic deliveries to private residential addresses.

### 5. CLAIM PROCESSING

5.1. Shortages, visible damage and damaged packaging, but also the suspicion of possible damage must be reflected on the carrier's delivery note (not on Vibia's one) by signing making a reservation to check the goods and the claim shall be sent by fax or email to Vibia no later than 24 hours from receipt of the goods (copy of the transporter's delivery note with the claim comment) for the purpose of compliance with deadlines and faster processing directly to Vibia in Barcelona.

5.2. Non-compliance with point 5.1 can lead to invalidity of a claim for damages on the basis of forwarding legal reasons and any necessary replacement (part) deliveries may be charged.

5.3. The buyer is not entitled to reduce the purchase price, to retain or request changes, unless a following improvement fails or a new delivery is impossible.

5.4. Claims for damages are excluded, except should be proved gross negligence of Vibia Lighting, S.L.U.

### 6. REPAIRS

6.1. If a trading partner desires to repair a lamp, before returning it is necessary to obtain from us an approval and a Return number. The lamp must be correctly packaged and the Return number clearly visible on the outside (otherwise, the delivery will be refused by the factory).

6.2. An estimate of cost will be issued after the lamp has been received in the factory.

6.3. The cost of transport is charged to the trading partner.

6.4. We will not repair lamps when these have been out of our catalogue for more than a year. Replacement parts may be ordered at extra cost, provided they are in stock.

### 7. RETURNS

7.1. Returns are allowed only in the case of claims and must be pre-authorized by us. We reserve the right to repair or replace. Defective goods will be picked up by a freight forwarder authorized by us. For this, we assign a Return number. Please ask us this number before making a return. The claimed goods must be packaged in the original packaging, complete and ready for transport - the Return number must be always visible on each carton (otherwise, the delivery will be refused by the factory), so that the processing can be carried out quickly and accurately.

7.2. In the case of damages due to a non proper return packaging, we reserve the right to charge the corresponding repair costs.

7.3. If after the inspection of the complaint it should be evident that such complaint was not justified, we reserve the right to charge for the expenses incurred.

7.4. Returns of goods. Returned goods will only be accepted with prior authorisation from our sales department, provided that no more than 3 months have passed since Vibia's invoice date, and with the guarantee that the material is returned unopened, in its original packaging. In this case, a depreciation of 15% will be applied to the customer. The cost of transport to Vibia will always be borne by the customer. In no event will returns of special, personalised or customised products be accepted.

### 8. WEB

8.1. To be able to work as an authorised distributor to sell and publish "VIBIA" brand lamps over the website, you must have signed the "AGREEMENT FOR THE ONLINE SALE OF VIBIA PRODUCTS". Ask your local VIBIA sales manager for the terms and conditions.

8.2. The presentation of pictures of the articles or similar forms of representation of VIBIA products, as well as the mentioning of brands in an Internet-based application or similar system must have the explicit written permission of the Vibia Lighting, S.L.U.

### 9. GENERAL REMARKS

9.1. Vibia Lighting, S.L.U. reserves the right to modify without prior notice the models of the current catalogue and valid price list or to take them out of the product range.

9.2. Printing errors reserved.

9.3. The confirmed delivery dates are not binding. Vibia Lighting, S.L.U. strives to comply with all commitments, but cannot be held liable under any circumstance.

9.4. Samplings are possible. Please ask us about the various possibilities.

9.5. Vibia Lighting, S.L.U. reserves the right to change discount rates given in any time.

9.6. Any additional service of the trading partner standing in connection with the distribution of VIBIA lamps (for example, replacement of lamps and components, travel for testing purposes etc.) are covered by the proven Vibia Lighting, S.L.U. trading range. Please refer to our sales guide. In case you should not have it, please ask us.

9.7. All goods, until full settlements of our claims, remain property of the Vibia Lighting, S.L.U.

9.8. The Buyer acknowledges the conditions of sale written down here.

9.9. Vibia Lighting S.L.U. reserves the right to cancel a client account if the outlined sales conditions or agreed commercial terms are not complied with, in the event of activities that may be considered unfair competition or the misrepresentation of the company's trade policies.

9.10. Place of performance and jurisdiction is for all trading partners. Barcelona.

Thanks, February 2024.

# Index

- Africa  
264
  - Algorithm Grid  
68
  - Algorithm Free  
62
  - Alpha  
396
  - Array  
112
  - Balance  
236
  - Bamboo  
218
  - Big  
54
  - Big Built-in  
58
  - Break  
188
  - Break Plus  
190
  - Brisa  
206
  - Class  
166
  - Cosmos  
156
  - Dama  
170
  - Domo  
400
  - Dots  
208
  - Dots Outdoor  
212
  - Duo  
222
  - Empty  
192
  - Flamingo  
96
  - Flamingo Mini  
100
  - Flat  
292
  - Fold Surface  
194
  - Funnel  
122
  - Ghost  
232
  - Guise  
130
  - Halo Circular  
138
  - Halo Lineal  
142
  - Halo Jewel  
146
  - Halo Wall  
154
  - I. Cono  
60
  - Jazz  
94
  - June  
216
  - Knit  
380
  - Kontur  
356
  - Match  
404
  - Mayfair  
256
  - Mayfair Mini  
254
  - Meridiano  
214
  - Musa  
378
  - North  
266
  - Origami  
200
  - Out  
196
  - Palma  
174
  - Palo Alto  
204
  - Pin  
104
  - Plis Outdoor  
182
  - Plusminus  
328
  - Puck  
238
  - Puck Wall Art  
242
  - Quadra Ice  
90
  - Rhythm Horizontal  
124
  - Rhythm Vertical  
128
  - Set  
390
  - Skan  
10
  - Slim  
80
  - Spa  
306
  - Sticks Connectable  
362
  - Sticks Stand-alone  
376
  - Structural  
160
  - Suite  
312
  - Tempo  
280
  - Top  
92
  - Tube  
320
  - Up  
198
  - Vol  
8
  - Warm  
226
  - Wind  
184
  - Wireflow  
20
  - Wireflow Chandelier  
50
  - Wireflow Freeform  
36
  - Wireflow Lineal  
32
  - 45°  
402
- 
- Bulbs  
408
  - Professional  
area at [vibia.com](http://vibia.com)  
409
  - Item coding  
6
  - Glossary  
410
  - Lighting control  
systems  
411

**Very important**

Vibia Lighting S.L.U. has the right to change any model or finish of the products included in the picture catalogue without any previous notice.

Vibia Lighting, S.L.U.

**Office**

Progrés 4-6.

08850 Gavà (Barcelona).

International Tel +34 934 796 971.

[customer.service@vibia.com](mailto:customer.service@vibia.com)

[vibia.com](http://vibia.com)

COPYRIGHT© VIBIA LIGHTING S.L.U. ALL RIGHTS RESERVED.

# Index

- Africa  
264
  - Algorithm Grid  
68
  - Algorithm Free  
62
  - Alpha  
396
  - Array  
112
  - Balance  
236
  - Bamboo  
218
  - Big  
54
  - Big Built-in  
58
  - Break  
188
  - Break Plus  
190
  - Brisa  
206
  - Class  
166
  - Cosmos  
156
  - Dama  
170
  - Domo  
400
  - Dots  
208
  - Dots Outdoor  
212
  - Duo  
222
  - Empty  
192
  - Flamingo  
96
  - Flamingo Mini  
100
  - Flat  
292
  - Fold Surface  
194
  - Funnel  
122
  - Ghost  
232
  - Guise  
130
  - Halo Circular  
138
  - Halo Lineal  
142
  - Halo Jewel  
146
  - Halo Wall  
154
  - I. Cono  
60
  - Jazz  
94
  - June  
216
  - Knit  
380
  - Kontur  
356
  - Match  
404
  - Mayfair  
256
  - Mayfair Mini  
254
  - Meridiano  
214
  - Musa  
378
  - North  
266
  - Origami  
200
  - Out  
196
  - Palma  
174
  - Palo Alto  
204
  - Pin  
104
  - Plis Outdoor  
182
  - Plusminus  
328
  - Puck  
238
  - Puck Wall Art  
242
  - Quadra Ice  
90
  - Rhythm Horizontal  
124
  - Rhythm Vertical  
128
  - Set  
390
  - Skan  
10
  - Slim  
80
  - Spa  
306
  - Sticks Connectable  
362
  - Sticks Stand-alone  
376
  - Structural  
160
  - Suite  
312
  - Tempo  
280
  - Top  
92
  - Tube  
320
  - Up  
198
  - Vol  
8
  - Warm  
226
  - Wind  
184
  - Wireflow  
20
  - Wireflow Chandelier  
50
  - Wireflow Freeform  
36
  - Wireflow Lineal  
32
  - 45°  
402
- 
- Bulbs  
408
  - Professional  
area at [vibia.com](http://vibia.com)  
409
  - Item coding  
6
  - Glossary  
410
  - Lighting control  
systems  
411

# Item coding

Some pendant models offer different electrical connection typology, these will require additional coding.

## ITEM CODING

Reference

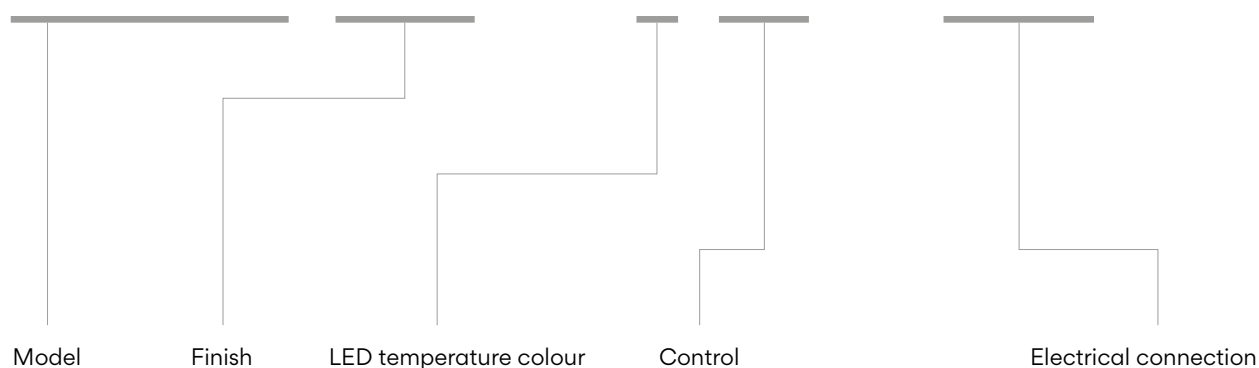

Model

Finish

LED temperature colour

Control

Electrical connection

4 digits

2 digits

1 digit

1 digit

2 digits

Type

Model

- 0 Without LED
- 1 2700 K
- 2 3000 K
- 3 3500 K
- 4 4000 K
- 7 2200 K

- 0 On/ Off
- 1 DALI
- 2 0-10V
- 3 1-10V
- 4 TRIAC
- 5 Push
- 6 Sensor
- A 1+3+5 (DALI + 1-10V + Push)
- B 3+5 (1-10V + Push)
- C 1+3 (DALI + 1-10V)
- E Casambi P2P + On/ Off
- F Simultaneous line DALI + 1-10V + Push + Casambi
- Z Casambi \*
- M Without driver

- 1 Surface
- 2 Built-in
- 3 Remote
- 4 Bolt-down

- 0 Basic
- 1 Micro
- 2 XXS
- 3 XS
- 4 S
- 5 M
- 6 L
- 8 Free wire
- 9 Mud kit

\* Casambi refers to wireless dimming solutions. Ask for more information.

Should you need a non-standard product. Please, request sales conditions.

Over the course of this year we shall proceed to standardise our finish codes.



# Vol

Design by Lievore, Altherr, Molina

Vol combines traditional techniques and cutting-edge lighting capabilities. Smooth and streamlined, the simple oval forms create a delicate focal point in a space.

## Pendants



ø 60 cm

**0225**

|             |   |   |   |  |  |
|-------------|---|---|---|--|--|
| <b>0225</b> |  | <b>Finishes</b><br>● <b>03 White</b><br>(RAL 9016)          | <b>LED temperature colour</b><br>2700 K 800 lm/W  | <b>0225 03</b>   | <b>895,00 €</b>  |
|             | <b>Materials</b><br>Shade: Glass. Disc: Aluminum.                                   | <b>Light Source and electronics</b><br>4 x LED E27 230V 9 W | <b>Packaging</b><br>1 Box 0,78 x 0,78 x 0,50 m<br>Vol 0,3000 m <sup>3</sup><br>Gross weight 11 Kg Net weight 9 Kg | <b>Notes</b><br>Extra cable length. 16,00 €/m<br><b>UNTIL STOCK RUNS OUT</b> |  |



1160 10 /1A  
Model Finish  
LED temperature colour  
Control

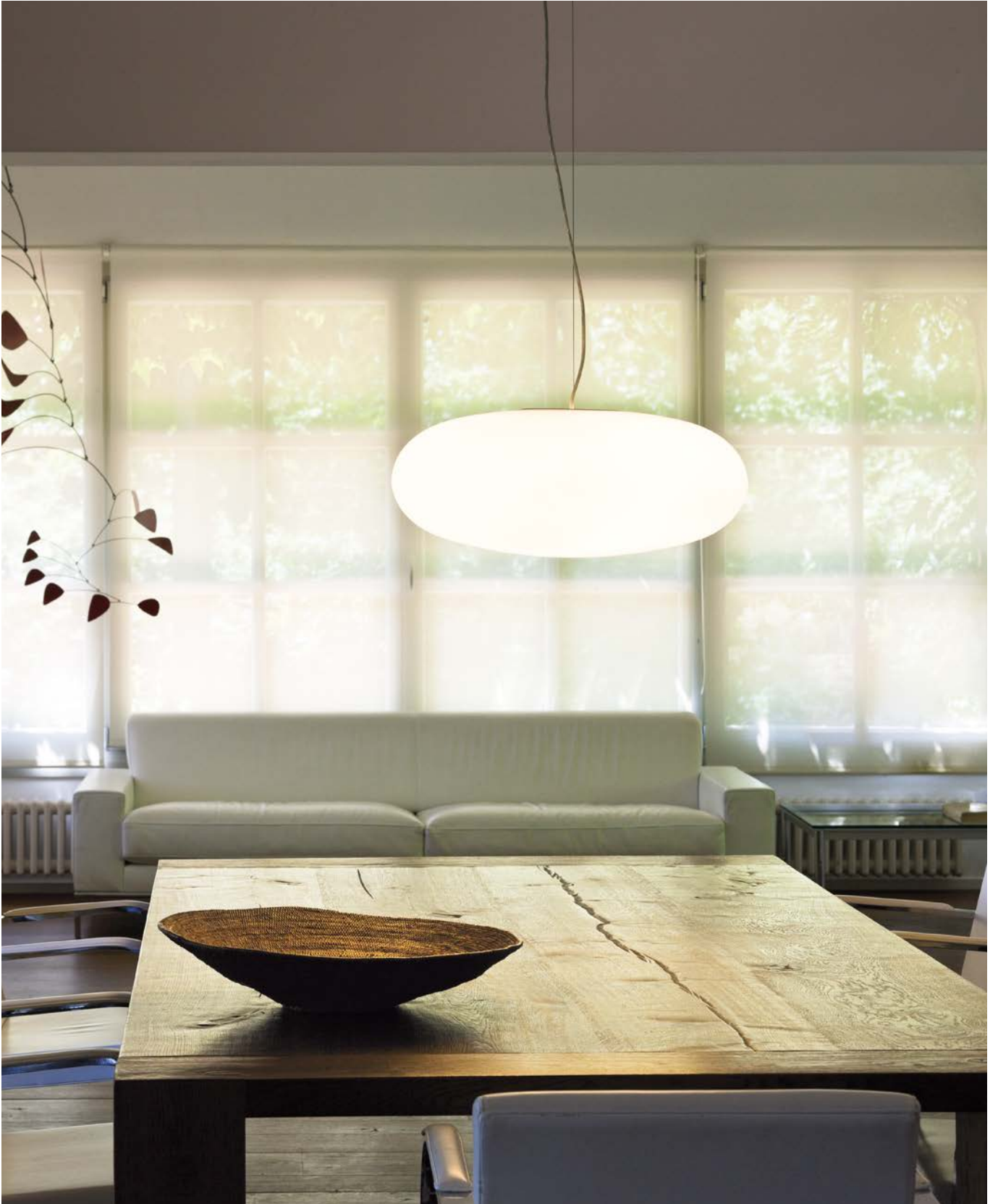

# Skán

Design by Lievore, Altherr, Molina

Minimal volume and maximum lighting functionality. Skán represents a return to what is essential: pure, delicate lines in which the light is the fundamental element while the shape is almost invisible.

## Floor

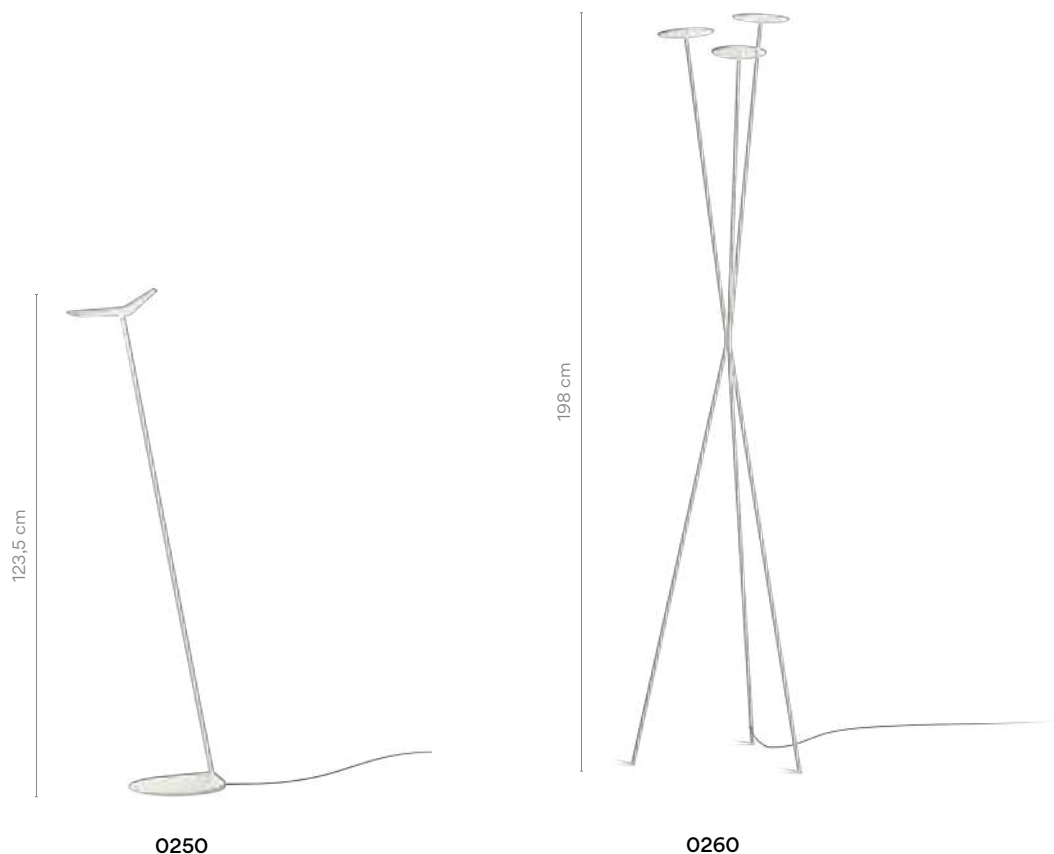

|                    |   |  |
|--------------------|---|--|
| <p><b>0250</b></p> | <p><b>Finishes</b></p> <ul style="list-style-type: none"> <li>● <b>10/</b> _ _ White (NCS S 0300-N)</li> <li>● <b>11/</b> _ _ Black (NCS S 8500-N)</li> <li>● <b>37/</b> _ _ Terra Red (NCS S4040-Y70R)</li> </ul> <p><b>Finish customization</b><br/>(Available options:<br/>Vibia colour palette)</p> <hr/> <p><b>Materials</b><br/>Head: Aluminum. Diffuser: Methacrylate.<br/>Base: Zamak.</p> <p><b>Light Source and electronics</b><br/>1 x LED PLATE 24V 8 W<br/>Constant Voltage 24V<br/>110-240V 50/60Hz</p> | <p><b>LED temperature colour</b><br/><b>/2</b> _ 3000 K<br/>CRI &gt;80 339,2 lm 42,4 lm/W</p> <p><b>Control</b><br/><b>0250</b> _ _ / _ 6<br/>Optical Sensor</p> <hr/> <p><b>Packaging</b><br/>1 Box 1,50 x 0,34 x 0,32 m<br/>Vol 0,0418 m<sup>3</sup><br/>Gross weight 6 Kg Net weight 3 Kg</p> <p><b>Notes</b><br/><b>UNTIL STOCK RUNS OUT</b></p> <p>LED  IP20   </p> <p>Dimmer  Bi-volt </p> |
|                    |   | <b>660,00 €</b>  |



0260

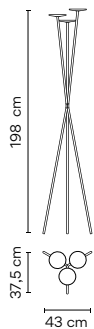

Finishes

- 10/ \_\_ White (NCS S 0300-N)
- 11/ \_\_ Black (NCS S 8500-N)
- 37/ \_\_ Terra Red (NCS S4040-Y70R)

Finish customization  
 (Available options:  
 Vibia colour palette)

LED temperature colour

- /1\_ 2700 K  CRI >90 4430,16 lm 159 lm/W
- /2\_ 3000 K  E CRI >90 3792,73 lm 136 lm/W
- /3\_ 3500 K  D CRI >90 4799,9 lm 172,0 lm/W

Control

0260 \_\_ / \_ 5  
 Push

985,00 €

Materials

Head: Aluminum. Diffuser: Methacrylate.  
 Vertical tube: Steel.

Light Source and electronics

3 x LED 9,2 W 500 mA  
 Constant Current 500 mA  
 110-240V 50/60Hz

Packaging

1 Box 2,11 x 0,60 x 0,60 m  
 Vol 0,7596 m<sup>3</sup>  
 Gross weight 5,4 Kg Net weight 2,5 Kg

LED  IP20  CE  EAC    
 Dimmer  Bi-volt

---

Pendants

0270



ø 30 cm

0271



ø 30 cm

0275



ø 60 cm

0276



ø 60 cm

0280

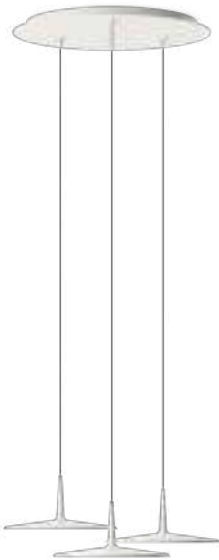

ø 30 cm

0282



ø 30 cm

0270

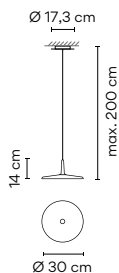

| Finishes                             | LED temperature colour                     | Control                  |          |
|--------------------------------------|--|--------------------------|----------|
| 10/ __ White<br>(NCS S 0300-N)       | /1_ 2700 K<br>CRI >90 1269 lm 141 lm/W     | 0270 __ / _ 1<br>DALI-2  | 460,00 € |
| 11/ __ Black<br>(NCS S 8500-N)       | /2_ 3000 K<br>CRI >80 1123 lm 125 lm/W     | 0270 __ / _ 2<br>0-10V   | 435,00 € |
| 24/ __ Beige M1<br>(NCS S 2005-Y50R) | /3_ 3500 K<br>CRI >90 1374,9 lm 152,8 lm/W | 0270 __ / _ Z<br>Casambi | 555,00 € |
| 37/ __ Terra Red<br>(NCS S4040-Y70R) |  |                          |          |
| 42/ __ Blue M1<br>(NCS S 5010-B10G)  |  |                          |          |
| 47/ __ Green L1<br>(NCS S 4005-G80Y) |  |                          |          |

Finish customization  
(Available options:  
Vibia colour palette)

Materials

Body: Aluminum. Diffuser: Methacrylate.  
Canopy Plate: Steel.

Light Source and electronics

1 x LED 9,3 W 350 mA  
Constant Current 350 mA  
110-277V 50/60Hz

Packaging

1 Box 0,29 x 0,38 x 0,38 m  
Vol 0,0418 m<sup>3</sup>  
Gross weight 2,6 Kg Net weight 1,4 Kg

Notes

Surface.  
Extra cable length. 16,00 €/m

LED IP20 CE EAC Bi-volt

Electrical connection

- Surface
- \_18 Free Wire
- \_23 Built-in
- \_31 Remote
- Micro for plaster ceilings
- \_32 Remote
- XXS for all types of drop ceilings

0271

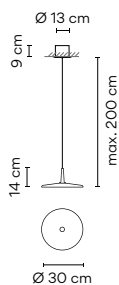

| Finishes                             | LED temperature colour                     | Control                      |          |
|--------------------------------------|--|------------------------------|----------|
| 10/ __ White<br>(NCS S 0300-N)       | /1_ 2700 K<br>CRI >90 1269 lm 141 lm/W     | 0271 __ / _ 1<br>DALI        | 460,00 € |
| 11/ __ Black<br>(NCS S 8500-N)       | /2_ 3000 K<br>CRI >80 1269 lm 125 lm/W     | 0271 __ / _ B<br>1-10V, Push | 435,00 € |
| 24/ __ Beige M1<br>(NCS S 2005-Y50R) | /3_ 3500 K<br>CRI >90 1374,9 lm 152,8 lm/W | 0271 __ / _ Z<br>Casambi     | 555,00 € |
| 37/ __ Terra Red<br>(NCS S4040-Y70R) |  |                              |          |
| 42/ __ Blue M1<br>(NCS S 5010-B10G)  |  |                              |          |
| 47/ __ Green L1<br>(NCS S 4005-G80Y) |  |                              |          |

Finish customization  
(Available options:  
Vibia colour palette)

Materials

Body: Aluminum. Diffuser: Methacrylate.  
Canopy Plate: Steel.

Light Source and electronics

1 x LED 9,3 W 350 mA  
Constant Current 350 mA  
110-240V 50/60Hz

Packaging

1 Box 0,29 x 0,38 x 0,38 m  
Vol 0,0418 m<sup>3</sup>  
Gross weight 2,5 Kg Net weight 1,4 Kg

Notes

Built-in.  
Extra cable length. 16,00 €/m  
**UNTIL STOCK RUNS OUT**

LED IP20 CE EAC Bi-volt ø 11,5 cm

0275

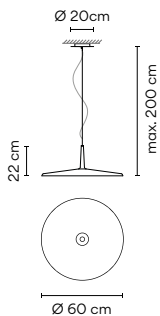

- Finishes**
- 10/ \_\_ White (NCS S 0300-N)
  - 11/ \_\_ Black (NCS S 8500-N)
  - 24/ \_\_ Beige M1 (NCS S 2005-Y50R)
  - 37/ \_\_ Terra Red (NCS S4040-Y70R)
  - 42/ \_\_ Blue M1 (NCS S 5010-B10G)
  - 47/ \_\_ Green L1 (NCS S 4005-G80Y)
- Finish customization**  
(Available options:  
Vibia colour palette)

- LED temperature colour**
- /1\_ 2700 K F CRI >90 1269 lm 91 lm/W
  - /2\_ 3000 K E CRI >80 1575 lm 113 lm/W
  - /3\_ 3500 K F CRI >90 1375,3 lm 98,9 lm/W

| Control                      |          |
|------------------------------|----------|
| 0275 __ / _ 1<br>DALI-2      | 805,00 € |
| 0275 __ / _ B<br>1-10V, Push | 765,00 € |
| 0275 __ / _ Z<br>Casambi     | 885,00 € |

**Materials**

Body: Aluminum. Diffuser: Methacrylate.  
Canopy Plate: Steel.

**Light Source and electronics**

1 x LED 13,9 W 500 mA  
Constant Current 500 mA  
110-240V 50/60Hz

**Packaging**

1 Box 0,42 x 0,71 x 0,66 m  
Vol 0,2000 m<sup>3</sup>  
Gross weight 7 Kg Net weight 4,4 Kg

**Notes**

Surface.  
Extra cable length. 16,00 €/m



0276

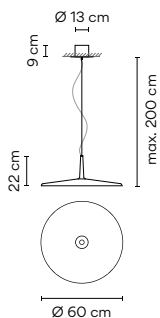

- Finishes**
- 10/ \_\_ White (NCS S 0300-N)
  - 11/ \_\_ Black (NCS S 8500-N)
  - 24/ \_\_ Beige M1 (NCS S 2005-Y50R)
  - 37/ \_\_ Terra Red (NCS S4040-Y70R)
  - 42/ \_\_ Blue M1 (NCS S 5010-B10G)
  - 47/ \_\_ Green L1 (NCS S 4005-G80Y)
- Finish customization**  
(Available options:  
Vibia colour palette)

- LED temperature colour**
- /1\_ 2700 K F CRI >90 1269 lm 91 lm/W
  - /2\_ 3000 K E CRI >80 1575 lm 113 lm/W
  - /3\_ 3500 K F CRI >90 1375,3 lm 98,9 lm/W

| Control                      |            |
|------------------------------|------------|
| 0276 __ / _ 1<br>DALI-2      | 975,00 €   |
| 0276 __ / _ B<br>1-10V, Push | 925,00 €   |
| 0276 __ / _ Z<br>Casambi     | 1.045,00 € |

**Materials**

Body: Aluminum. Diffuser: Methacrylate.  
Canopy Plate: Steel.

**Light Source and electronics**

1 x LED 13,9 W 500 mA  
Constant Current 500 mA  
110-240V 50/60Hz

**Packaging**

1 Box 0,42 x 0,71 x 0,66 m  
Vol 0,2000 m<sup>3</sup>  
Gross weight 7 Kg Net weight 4,4 Kg

**Notes**

Suitable for built-in and surface fitting.  
Extra cable length. 16,00 €/m

**UNTIL STOCK RUNS OUT**

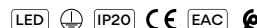

Bi-volt ∅ 11,5 cm

0280

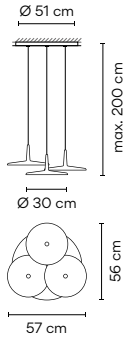

Finishes

- 10/ \_\_ White (NCS S 0300-N)
- 11/ \_\_ Black (NCS S 8500-N)
- 24/ \_\_ Beige M1 (NCS S 2005-Y50R)
- 37/ \_\_ Terra Red (NCS S4040-Y70R)
- 42/ \_\_ Blue M1 (NCS S 5010-B10G)
- 47/ \_\_ Green L1 (NCS S 4005-G80Y)

Finish customization  
 (Available options:  
 Vibia colour palette)

LED temperature colour

- /1\_ 2700 K CRI >90 3123 lm 112 lm/W
- /2\_ 3000 K CRI >80 3369 lm 121 lm/W
- /3\_ 3500 K CRI >90 4124,7 lm 147,8 lm/W

Control

|                              |            |
|------------------------------|------------|
| 0280 __ / _ 1<br>DALI-2      | 1.420,00 € |
| 0280 __ / _ B<br>1-10V, Push | 1.350,00 € |
| 0280 __ / _ Z<br>Casambi     | 1.470,00 € |

Materials

Body: Aluminum. Diffuser: Methacrylate.  
 Canopy Plate: Steel.

Light Source and electronics

3 x LED 9,3 W 350 mA  
 Constant Current 350 mA  
 110-240V 50/60Hz

Packaging

2 Boxes  
 Total Vol 0,2226 m<sup>3</sup>  
 Gross weight 13,7 Kg Net weight 9,2 Kg

Notes

Surface.  
 Extra cable length. 16,00 €/m



0282

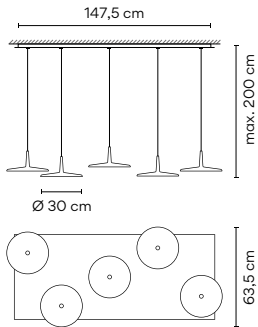

Finishes

- 10/ \_\_ White (NCS S 0300-N)
- 11/ \_\_ Black (NCS S 8500-N)
- 24/ \_\_ Beige M1 (NCS S 2005-Y50R)
- 37/ \_\_ Terra Red (NCS S4040-Y70R)
- 42/ \_\_ Blue M1 (NCS S 5010-B10G)
- 47/ \_\_ Green L1 (NCS S 4005-G80Y)

Finish customization  
 (Available options:  
 Vibia colour palette)

LED temperature colour

- /1\_ 2700 K CRI >90 5205 lm 112 lm/W
- /2\_ 3000 K CRI >80 5615 lm 121 lm/W
- /3\_ 3500 K CRI >90 6874,5 lm 147,8 lm/W

Control

|                              |            |
|------------------------------|------------|
| 0282 __ / _ 1<br>DALI-2      | 2.755,00 € |
| 0282 __ / _ B<br>1-10V, Push | 2.620,00 € |
| 0282 __ / _ Z<br>Casambi     | 2.740,00 € |

Materials

Body: Aluminum. Diffuser: Methacrylate.  
 Canopy Plate: Steel.

Light Source and electronics

5 x LED 9,3 W 350mA  
 Constant Current 350 mA  
 110-240V 50/60Hz

Packaging

2 Boxes  
 Total Vol 0,3290 m<sup>3</sup>  
 Gross weight 36,9 Kg Net weight 29 Kg

Notes

Surface.  
 Extra cable length. 16,00 €/m



# Composing pendants

Next sketches are composed by one or more compositions

---

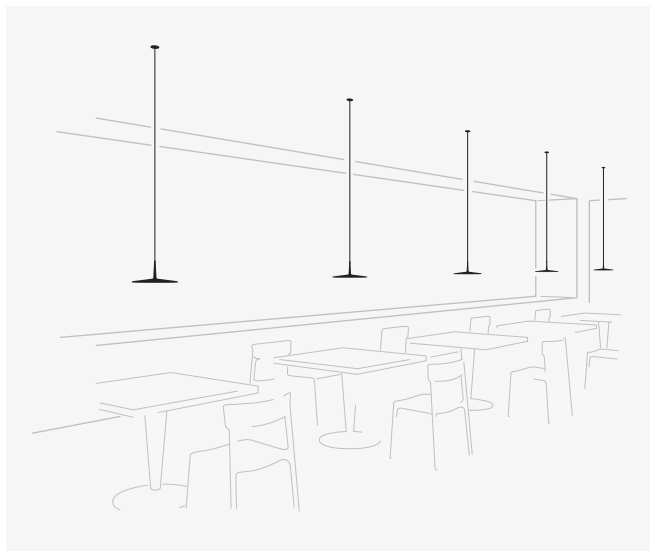

5 x 0270.

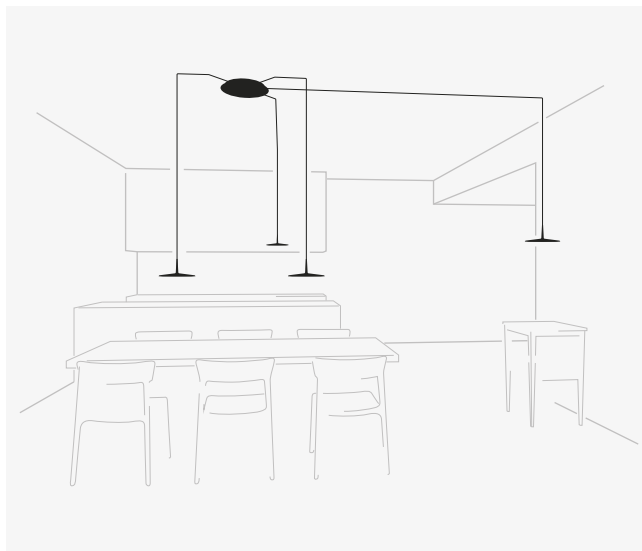

4 x 0270.

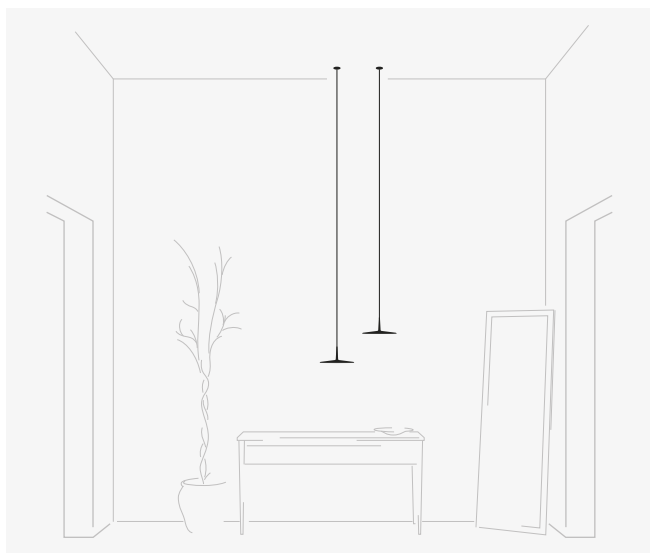

2 x 0270.

Each project is unique.  
Visit [vibia.com](http://vibia.com) and  
chose among multiple  
compositions designed  
and adapted to your  
project needs.

Personalise your own  
Skan composition quick  
and easy at [vibia.com](http://vibia.com)





# Electrical connection options for model 0270

Choose your preferred installation option according to your needs. For each composition, the optimal minimum number of drivers will be delivered.

## Drop ceiling

The innovative remote and built-in fittings accentuate the silkiness and lightness of compositions on suspended ceilings, its great visual grandeur taking center stage.

For Ref. 0270

### Remote

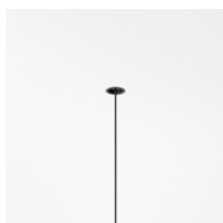

**Micro**  $\varnothing$  3 cm  
height 7 cm  
for plaster ceilings.  
Black finish.

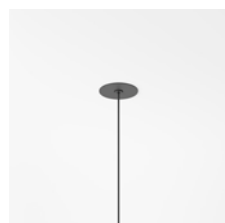
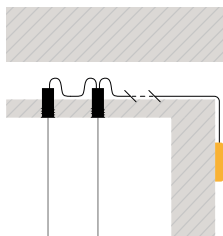

**XXS**  $\varnothing$  6 cm  
height 6 cm  
for all types of drop  
ceilings. Match with  
fixture finish.

### Built-in



$\varnothing$  8 cm  
height 6 cm  
match with  
fixture finish.

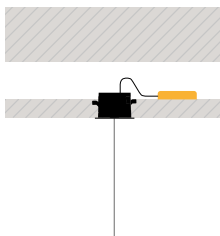

## Regular ceiling

When architecture does not allow for performance, surface and free wire showcase possibilities for any need or desire with no limits, ideal for both individual or cluster arrangements.

For Ref. 0270

### Surface



ø 17,3 cm  
match with  
fixture finish.

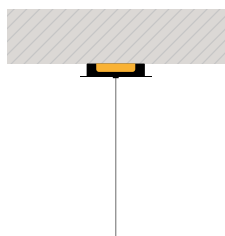

### Free Wire



1 wire

ø 20 cm



2 wires

ø 22 cm



3 - 6 wires

ø 36 cm



7 - 8 wires

ø 40 cm

you can choose the finish of the canopy  
among black, white or any colour  
matching one of the pendants.

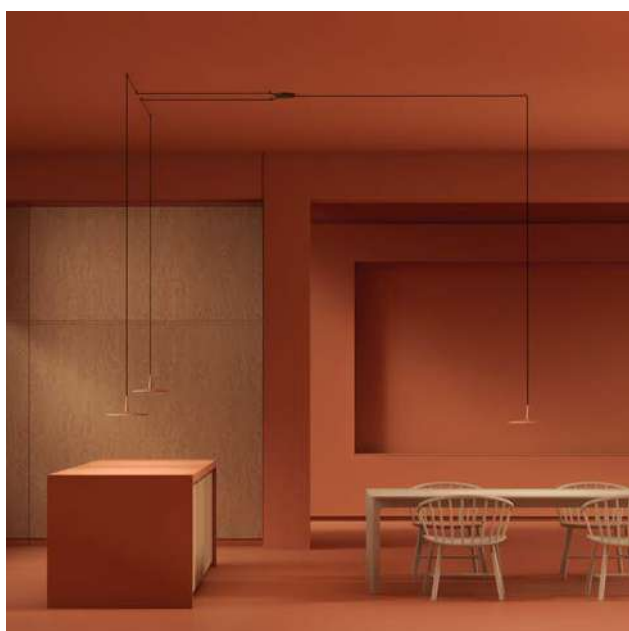
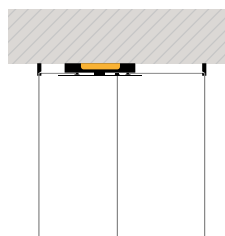

# Wireflow

Design by Arik Levy

Crafted of black, electrical cables, Volumetric's airy, three-dimensional outline lends it the feeling of being at once present and absent. The geometric volumes are tipped with LED light terminals in a contemporary take on the traditional chandelier.



Each project is unique. Visit [vibia.com](http://vibia.com) and chose among multiple compositions designed and adapted to your project needs.

Personalise your own Wireflow composition quick and easy at [vibia.com](http://vibia.com)

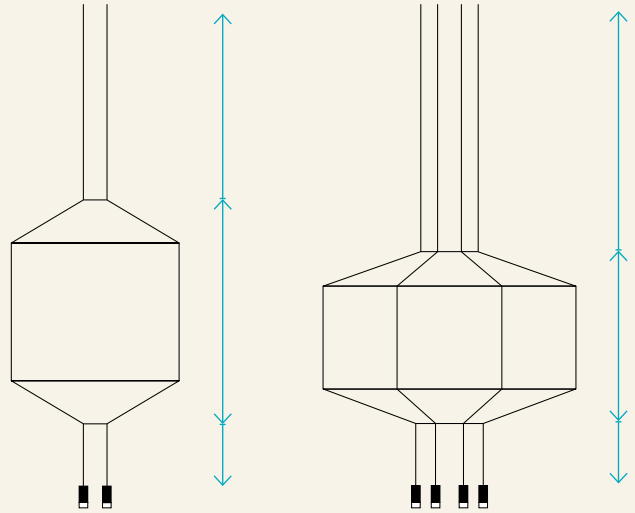

Pressed-glass diffuser.  
 \*Without pressed-glass diffuser.



0299

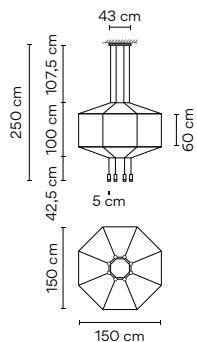

Finishes  
 ● 04/ \_\_ Black (RAL 9005)

LED temperature colour  
 /1 \_ 2700 K [D] CRI >90 3880 lm 121 lm/W  
 /2 \_ 3000 K [E] CRI >90 3880 lm 121 lm/W  
 /3 \_ 3500 K [E] CRI >90 4002,4 lm 125,1 lm/W

Control  
 0299 \_\_ / \_ A 2.415,00 €  
 DALI-2, 1-10V, Push  
 0299 \_\_ / \_ Z 2.535,00 €  
 Casambi

Materials  
 Diffuser: Pressed-glass. Horizontal rods: Steel.  
 Body: Aluminum Canopy: Steel.

Light Source and electronics  
 8 x LED 4,5 W 350 mA  
 Constant Current 350 mA  
 110-240V 50/60Hz

Packaging  
 2 Boxes  
 Total Vol 0,3245 m³  
 Gross weight 20,6 Kg Net weight 9,6 Kg

Notes  
 Pressed-glass diffuser.  
**Configuration layout at vibia.com**  
 Min. quantity, upcharge and extra lead time apply



0300

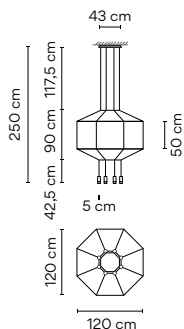

|  |  |  |  |
|--|--|--|--|
| <b>Finishes</b><br>● <b>04/</b> __ Black<br>(RAL 9005) | <b>LED temperature colour</b><br>/1 _ 2700 K<br>CRI >90 3880 lm 121 lm/W | <b>Control</b><br><b>0300</b> __ / __ A <span style="float: right;">2.350,00 €</span><br>DALI-2, 1-10V, Push |  |
|  | /2 _ 3000 K<br>CRI >90 3880 lm 121 lm/W                                  |  | <b>0300</b> __ / __ Z <span style="float: right;">2.470,00 €</span><br>Casambi |
|  | /3 _ 3500 K<br>CRI >90 4002,4 lm 125,1 lm/W                              |  |  |

**Materials**  
 Diffuser: Pressed-glass. Horizontal rods: Steel.  
 Body: Aluminum Canopy: Steel.

**Light Source and electronics**  
 8 x LED 4,5 W 350 mA  
 Constant Current 350 mA  
 110-240V 50/60Hz

**Packaging**  
 2 Boxes  
 Total Vol 0,3246 m<sup>3</sup>  
 Gross weight 19,95 Kg Net weight 8,95 Kg

**Notes**  
 Pressed-glass diffuser.

**Configuration layout at vibia.com**  
 Min. quantity, upcharge and extra lead time apply



0301

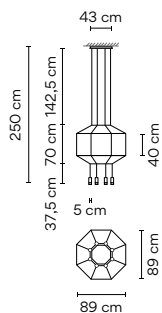

|  |  |  |  |
|--|--|--|--|
| <b>Finishes</b><br>● <b>04/</b> __ Black<br>(RAL 9005) | <b>LED temperature colour</b><br>/1 _ 2700 K<br>CRI >90 3880 lm 121 lm/W | <b>Control</b><br><b>0301</b> __ / __ A <span style="float: right;">2.245,00 €</span><br>DALI-2, 1-10V, Push |  |
|  | /2 _ 3000 K<br>CRI >90 3880 lm 121 lm/W                                  |  | <b>0301</b> __ / __ Z <span style="float: right;">2.365,00 €</span><br>Casambi |
|  | /3 _ 3500 K<br>CRI >90 4002,4 lm 125,1 lm/W                              |  |  |

**Materials**  
 Diffuser: Pressed-glass. Horizontal rods: Steel.  
 Body: Aluminum Canopy: Steel.

**Light Source and electronics**  
 8 x LED 4,5 W 350 mA  
 Constant Current 350 mA  
 110-240V 50/60Hz

**Packaging**  
 2 Boxes  
 Total Vol 0,2100 m<sup>3</sup>  
 Gross weight 17,75 Kg Net weight 8,75 Kg

**Notes**  
 Pressed-glass diffuser.

**Configuration layout at vibia.com**  
 Min. quantity, upcharge and extra lead time apply.



0302

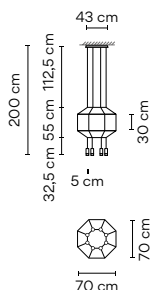

|  |  |  |  |
|--|--|--|--|
| <b>Finishes</b><br>● <b>04/</b> __ Black<br>(RAL 9005) | <b>LED temperature colour</b><br>/1 _ 2700 K<br>CRI >90 3880 lm 121 lm/W | <b>Control</b><br><b>0302</b> __ / __ A <span style="float: right;">2.210,00 €</span><br>DALI-2, 1-10V, Push |  |
|  | /2 _ 3000 K<br>CRI >90 3880 lm 121 lm/W                                  |  | <b>0302</b> __ / __ Z <span style="float: right;">2.330,00 €</span><br>Casambi |
|  | /3 _ 3500 K<br>CRI >90 4002,4 lm 125,1 lm/W                              |  |  |

**Materials**  
 Diffuser: Pressed-glass. Horizontal rods: Steel.  
 Body: Aluminum Canopy: Steel.

**Light Source and electronics**  
 8 x LED 4,5 W 350 mA  
 Constant Current 350 mA  
 110-240V 50/60Hz

**Packaging**  
 2 Boxes  
 Total Vol 0,1558 m<sup>3</sup>  
 Gross weight 14,6 Kg Net weight 8,6 Kg

**Notes**  
 Pressed-glass diffuser.

**Configuration layout at vibia.com**  
 Min. quantity, upcharge and extra lead time apply.



0303

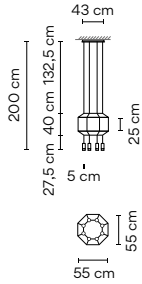

|   |  |  |
|---|--|--|
| <b>Finishes</b><br>● 04/ _ _ Black (RAL 9005) | <b>LED temperature colour</b><br>/1 _ 2700 K  CRI >90 3880 lm 121 lm/W<br>/2 _ 3000 K  CRI >90 3880 lm 121 lm/W<br>/3 _ 3500 K  CRI >90 4002,4 lm 125,1 lm/W | <b>Control</b><br>0303 _ _ / _ A 2.125,00 €<br>DALI-2, 1-10V, Push<br>0303 _ _ / _ Z 2.245,00 €<br>Casambi |
|---|--|--|

**Materials**  
 Diffuser: Pressed-glass. Horizontal rods: Steel.  
 Body: Aluminum Canopy: Steel.

**Light Source and electronics**  
 8 x LED 4,5 W 350 mA  
 Constant Current 350 mA  
 110-240V 50/60Hz

**Packaging**  
 2 Boxes  
 Total Vol 0,1558 m³  
 Gross weight 13 Kg Net weight 8,5 Kg

**Notes**  
 Pressed-glass diffuser.  
**Configuration layout at vibia.com**  
 Min. quantity, upcharge and extra lead time apply.



0304

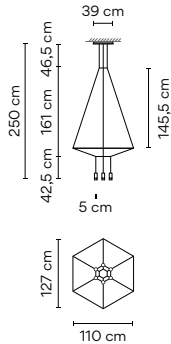

|   |  |  |
|---|--|--|
| <b>Finishes</b><br>● 04/ _ _ Black (RAL 9005) | <b>LED temperature colour</b><br>/1 _ 2700 K  CRI >90 2910 lm 121 lm/W<br>/2 _ 3000 K  CRI >90 2910 lm 121 lm/W<br>/3 _ 3500 K  CRI >90 3001,8 lm 125,1 lm/W | <b>Control</b><br>0304 _ _ / _ A 1.840,00 €<br>DALI-2, 1-10V, Push<br>0304 _ _ / _ Z 1.960,00 €<br>Casambi |
|---|--|--|

**Materials**  
 Diffuser: Pressed-glass. Horizontal rods: Steel.  
 Body: Aluminum Canopy: Steel.

**Light Source and electronics**  
 6 x LED 4,5W 350 mA  
 Constant Current 350 mA  
 110-240V 50/60Hz

**Packaging**  
 2 Boxes  
 Total Vol 0,3245 m³  
 Gross weight 15,55 Kg Net weight 5,65 Kg

**Notes**  
 Pressed-glass diffuser.  
**Configuration layout at vibia.com**  
 Min. quantity, upcharge and extra lead time apply.



UNTIL STOCK RUNS OUT

0305

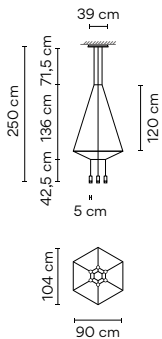

|   |  |  |
|---|--|--|
| <b>Finishes</b><br>● 04/ _ _ Black (RAL 9005) | <b>LED temperature colour</b><br>/1 _ 2700 K  CRI >90 2910 lm 121 lm/W<br>/2 _ 3000 K  CRI >90 2910 lm 121 lm/W<br>/3 _ 3500 K  CRI >90 3001,8 lm 125,1 lm/W | <b>Control</b><br>0305 _ _ / _ A 1.755,00 €<br>DALI-2, 1-10V, Push<br>0305 _ _ / _ Z 1.875,00 €<br>Casambi |
|---|--|--|

**Materials**  
 Diffuser: Pressed-glass. Horizontal rods: Steel.  
 Body: Aluminum Canopy: Steel.

**Light Source and electronics**  
 6 x LED 4,5W 350 mA  
 Constant Current 350 mA  
 110-240V 50/60Hz

**Packaging**  
 2 Boxes  
 Total Vol 0,2100 m³  
 Gross weight 13,2 Kg Net weight 3,5 Kg

**Notes**  
 Pressed-glass diffuser.  
**Configuration layout at vibia.com**  
 Min. quantity, upcharge and extra lead time apply.

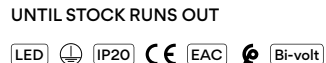

UNTIL STOCK RUNS OUT

0306

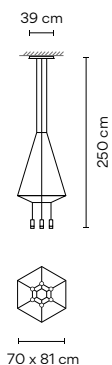

|  |   |  |
|--|---|--|
| <b>Finishes</b><br>● <b>O4/</b> __ Black<br>(RAL 9005) | <b>LED temperature colour</b><br>/1 _ 2700 K <b>D</b><br>CRI >90 2910 lm 121 lm/W | <b>Control</b><br><b>0306</b> __ / _ A <span style="float: right;"><b>1.650,00 €</b></span><br>DALI-2, 1-10V, Push |
|  | /2 _ 3000 K <b>E</b><br>CRI >90 2910 lm 121 lm/W                                  | <b>0306</b> __ / _ Z <span style="float: right;"><b>1.770,00 €</b></span><br>Casambi                               |
|  | /3 _ 3500 K <b>E</b><br>CRI >90 3001,8 lm 125,1 lm/W                              |  |

**Materials**  
 Diffuser: Pressed-glass. Horizontal rods: Steel.  
 Body: Aluminum Canopy: Steel.

**Light Source and electronics**  
 6 x LED 4,5W 350 mA  
 Constant Current 350 mA  
 110-240V 50/60Hz

**Packaging**  
 2 Boxes  
 Total Vol 0,2100 m<sup>3</sup>  
 Gross weight 13,1 Kg Net weight 5,2 Kg

**Notes**  
 Pressed-glass diffuser.

**Configuration layout at vibia.com**  
 Min. quantity, upcharge and extra lead time apply.

**UNTIL STOCK RUNS OUT**



0307

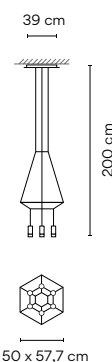

|  |   |  |
|--|---|--|
| <b>Finishes</b><br>● <b>O4/</b> __ Black<br>(RAL 9005) | <b>LED temperature colour</b><br>/1 _ 2700 K <b>D</b><br>CRI >90 2910 lm 121 lm/W | <b>Control</b><br><b>0307</b> __ / _ A <span style="float: right;"><b>1.570,00 €</b></span><br>DALI-2, 1-10V, Push |
|  | /2 _ 3000 K <b>E</b><br>CRI >90 2910 lm 121 lm/W                                  | <b>0307</b> __ / _ Z <span style="float: right;"><b>1.690,00 €</b></span><br>Casambi                               |
|  | /3 _ 3500 K <b>E</b><br>CRI >90 3001,8 lm 125,1 lm/W                              |  |

**Materials**  
 Diffuser: Pressed-glass. Horizontal rods: Steel.  
 Body: Aluminum Canopy: Steel.

**Light Source and electronics**  
 6 x LED 4,5W 350mA  
 Constant Current 350 mA  
 110-240V 50/60Hz

**Packaging**  
 2 Boxes  
 Total Vol 0,1558 m<sup>3</sup>  
 Gross weight 10 Kg Net weight 5,1 Kg

**Notes**  
 Pressed-glass diffuser.

**Configuration layout at vibia.com**  
 Min. quantity, upcharge and extra lead time apply.

**UNTIL STOCK RUNS OUT**



0308

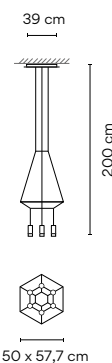

|  |   |  |
|--|---|--|
| <b>Finishes</b><br>● <b>O4/</b> __ Black<br>(RAL 9005) | <b>LED temperature colour</b><br>/1 _ 2700 K <b>D</b><br>CRI >90 2910 lm 121 lm/W | <b>Control</b><br><b>0308</b> __ / _ A <span style="float: right;"><b>1.515,00 €</b></span><br>DALI-2, 1-10V, Push |
|  | /2 _ 3000 K <b>E</b><br>CRI >90 2910 lm 121 lm/W                                  | <b>0308</b> __ / _ Z <span style="float: right;"><b>1.635,00 €</b></span><br>Casambi                               |
|  | /3 _ 3500 K <b>E</b><br>CRI >90 3001,8 lm 125,1 lm/W                              |  |

**Materials**  
 Diffuser: Pressed-glass. Horizontal rods: Steel.  
 Body: Aluminum Canopy: Steel.

**Light Source and electronics**  
 6 x LED 4,5W 350mA  
 Constant Current 350 mA  
 110-240V 50/60Hz

**Packaging**  
 2 Boxes  
 Total Vol 0,1238 m<sup>3</sup>  
 Gross weight 8,4 Kg Net weight 5 Kg

**Notes**  
 Pressed-glass diffuser.

**Configuration layout at vibia.com**  
 Min. quantity, upcharge and extra lead time apply.

**UNTIL STOCK RUNS OUT**





0309

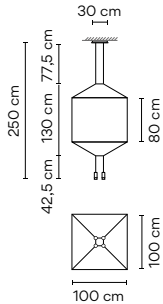

|   |   |  |
|---|---|--|
| <b>Finishes</b><br>● <b>04/ _ _ Black</b><br>(RAL 9005) | <b>LED temperature colour</b><br>/1 _ 2700 K <b>D</b><br>CRI >90 1940 lm 121 lm/W | <b>Control</b><br><b>0309 _ _ / _ A</b> <b>1.285,00 €</b><br>DALI-2, 1-10V, Push |
|   | /2 _ 3000 K <b>E</b><br>CRI >90 1940 lm 121 lm/W                                  | <b>0309 _ _ / _ Z</b> <b>1.405,00 €</b><br>Casambi                               |
|   | /3 _ 3500 K <b>E</b><br>CRI >90 2001,2 lm 125,1 lm/W                              |  |

**Materials**  
 Diffuser: Pressed-glass. Horizontal rods: Steel.  
 Body: Aluminum Canopy: Steel.

**Light Source and electronics**  
 4 x LED 4,5 W 350 mA  
 Constant Current 350 mA  
 110-240V 50/60Hz

**Packaging**  
 2 Boxes  
 Total Vol 0,2100 m³  
 Gross weight 12,3 Kg Net weight 5,3 Kg

**Notes**  
 Pressed-glass diffuser.  
**Configuration layout at vibia.com**  
 Min. quantity, upcharge and extra lead time apply.



0310

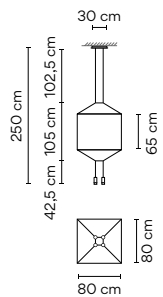

|   |   |  |
|---|---|--|
| <b>Finishes</b><br>● <b>04/ _ _ Black</b><br>(RAL 9005) | <b>LED temperature colour</b><br>/1 _ 2700 K <b>D</b><br>CRI >90 1940 lm 121 lm/W | <b>Control</b><br><b>0310 _ _ / _ A</b> <b>1.235,00 €</b><br>DALI-2, 1-10V, Push |
|   | /2 _ 3000 K <b>E</b><br>CRI >90 1940 lm 121 lm/W                                  | <b>0310 _ _ / _ Z</b> <b>1.355,00 €</b><br>Casambi                               |
|   | /3 _ 3500 K <b>E</b><br>CRI >90 2001,2 lm 125,1 lm/W                              |  |

**Materials**  
 Diffuser: Pressed-glass. Horizontal rods: Steel.  
 Body: Aluminum Canopy: Steel.

**Light Source and electronics**  
 4 x LED 4,5 W 350 mA  
 Constant Current 350 mA  
 110-240V 50/60Hz

**Packaging**  
 2 Boxes  
 Total Vol 0,2100 m³  
 Gross weight 11,8 Kg Net weight 4,8 Kg

**Notes**  
 Pressed-glass diffuser.  
**Configuration layout at vibia.com**  
 Min. quantity, upcharge and extra lead time apply.



0311

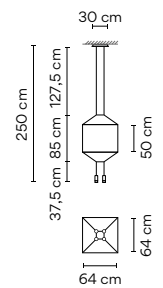

|   |   |  |
|---|---|--|
| <b>Finishes</b><br>● <b>04/ _ _ Black</b><br>(RAL 9005) | <b>LED temperature colour</b><br>/1 _ 2700 K <b>D</b><br>CRI >90 1940 lm 121 lm/W | <b>Control</b><br><b>0311 _ _ / _ A</b> <b>1.220,00 €</b><br>DALI-2, 1-10V, Push |
|   | /2 _ 3000 K <b>E</b><br>CRI >90 1940 lm 121 lm/W                                  | <b>0311 _ _ / _ Z</b> <b>1.340,00 €</b><br>Casambi                               |
|   | /3 _ 3500 K <b>E</b><br>CRI >90 2001,2 lm 125,1 lm/W                              |  |

**Materials**  
 Diffuser: Pressed-glass. Horizontal rods: Steel.  
 Body: Aluminum Canopy: Steel.

**Light Source and electronics**  
 4 x LED 4,5 W 350 mA  
 Constant Current 350 mA  
 110-240V 50/60Hz

**Packaging**  
 2 Boxes  
 Total Vol 0,1558 m³  
 Gross weight 8,7 Kg Net weight 4,7 Kg

**Notes**  
 Pressed-glass diffuser.  
**Configuration layout at vibia.com**  
 Min. quantity, upcharge and extra lead time apply.



0312

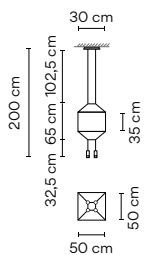

|  |  |  |
|--|--|--|
| <b>Finishes</b><br>● <b>04/</b> __ Black<br>(RAL 9005) | <b>LED temperature colour</b><br>/1 _ 2700 K<br>CRI >90 1940 lm 121 lm/W | <b>Control</b><br><b>0312</b> __ / _ A <span style="float: right;"><b>1.180,00 €</b></span><br>DALI-2, 1-10V, Push |
|  | /2 _ 3000 K<br>CRI >90 1940 lm 121 lm/W                                  | <b>0312</b> __ / _ Z <span style="float: right;"><b>1.300,00 €</b></span><br>Casambi                               |
|  | /3 _ 3500 K<br>CRI >90 2001,2 lm 125,1 lm/W                              |  |

**Materials**  
 Diffuser: Pressed-glass. Horizontal rods: Steel.  
 Body: Aluminum Canopy: Steel.

**Light Source and electronics**  
 8 x LED 4,5 W 350 mA  
 Constant Current 350 mA  
 110-240V 50/60Hz

**Packaging**  
 2 Boxes  
 Total Vol 0,1558 m<sup>3</sup>  
 Gross weight 8,6 Kg Net weight 4,6 Kg

**Notes**  
 Pressed-glass diffuser.

**Configuration layout at vibia.com**  
 Min. quantity, upcharge and extra lead time apply



0313

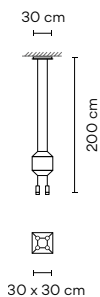

|  |  |  |
|--|--|--|
| <b>Finishes</b><br>● <b>04/</b> __ Black<br>(RAL 9005) | <b>LED temperature colour</b><br>/1 _ 2700 K<br>CRI >80 1961 lm 109 lm/W | <b>Control</b><br><b>0313</b> __ / _ A <span style="float: right;"><b>1.110,00 €</b></span><br>DALI-2, 1-10V, Push |
|  |  | <b>0313</b> __ / _ Z <span style="float: right;"><b>1.230,00 €</b></span><br>Casambi                               |

**Materials**  
 Diffuser: Pressed-glass. Horizontal rods: Steel.  
 Body: Aluminum Canopy: Steel.

**Light Source and electronics**  
 4 x LED 4,5 W 350 mA  
 Constant Current 350 mA  
 110-240V 50/60Hz

**Packaging**  
 2 Boxes  
 Total Vol 0,1238 m<sup>3</sup>  
 Gross weight 7 Kg Net weight 4,5 Kg

**Notes**  
 Pressed-glass diffuser.

**Configuration layout at vibia.com**  
 Min. quantity, upcharge and extra lead time apply.

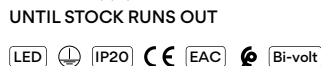

0399

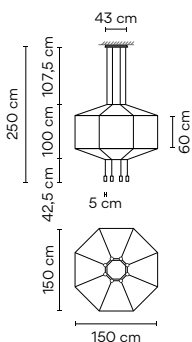

|  |  |  |
|--|--|--|
| <b>Finishes</b><br>● <b>04/</b> __ Black<br>(RAL 9005) | <b>LED temperature colour</b><br>/1 _ 2700 K<br>CRI >90 3880 lm 121 lm/W | <b>Control</b><br><b>0399</b> __ / _ A <span style="float: right;"><b>1.815,00 €</b></span><br>DALI-2, 1-10V, Push |
|  |  | <b>0399</b> __ / _ Z <span style="float: right;"><b>1.935,00 €</b></span><br>Casambi                               |

**Materials**  
 Diffuser: Polycarbonate. Horizontal rods: Steel.  
 Body: Aluminum Canopy: Steel.

**Light Source and electronics**  
 8 x LED 4,5 W 350 mA  
 Constant Current 350 mA  
 110-240V 50/60Hz

**Packaging**  
 2 Boxes  
 Total Vol 0,3245 m<sup>3</sup>  
 Gross weight 20,6 Kg Net weight 9,6 Kg

**Notes**  
 Without pressed-glass diffuser.

**Configuration layout at vibia.com**  
 Min. quantity, upcharge and extra lead time apply.

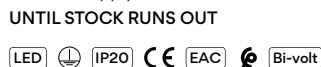

0400

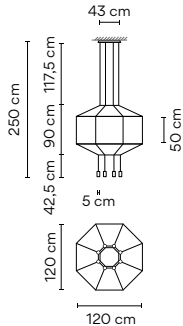

Finishes ● 04/ \_ \_ Black (RAL 9005)  
 LED temperature colour /1\_ 2700 K [D] CRI >90 3880 lm 121 lm/W

Control 0400 \_ \_ / \_ A 1.750,00 €  
 DALI-2, 1-10V, Push  
 0400 \_ \_ / \_ Z 1.870,00 €  
 Casambi

Materials  
 Diffuser: Polycarbonate. Horizontal rods: Steel.  
 Body: Aluminum Canopy: Steel.  
 Light Source and electronics  
 8 x LED 4,5 W 350 mA  
 Constant Current 350 mA  
 110-240V 50/60Hz

Packaging  
 2 Boxes  
 Total Vol 0,3245 m³  
 Gross weight 20,20 Kg Net weight 8,95 Kg

Notes  
 Without pressed-glass diffuser.  
 Configuration layout at [vibia.com](http://vibia.com)  
 Min. quantity, upcharge and extra lead time apply.

UNTIL STOCK RUNS OUT



0401

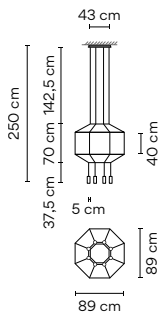

Finishes ● 04/ \_ \_ Black (RAL 9005)  
 LED temperature colour /1\_ 2700 K [D] CRI >90 3880 lm 121 lm/W

Control 0401 \_ \_ / \_ A 1.645,00 €  
 DALI-2, 1-10V, Push  
 0401 \_ \_ / \_ Z 1.765,00 €  
 Casambi

Materials  
 Diffuser: Polycarbonate. Horizontal rods: Steel.  
 Body: Aluminum Canopy: Steel.  
 Light Source and electronics  
 8 x LED 4,5 W 350 mA  
 Constant Current 350 mA  
 110-240V 50/60Hz

Packaging  
 2 Boxes  
 Total Vol 0,2100 m³  
 Gross weight 17,75 Kg Net weight 8,75 Kg

Notes  
 Without pressed-glass diffuser.  
 Configuration layout at [vibia.com](http://vibia.com)  
 Min. quantity, upcharge and extra lead time apply.

UNTIL STOCK RUNS OUT



0402

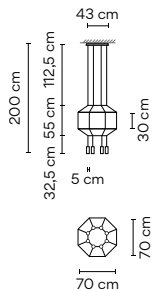

Finishes ● 04/ \_ \_ Black (RAL 9005)  
 LED temperature colour /1\_ 2700 K [D] CRI >90 3880 lm 121 lm/W

Control 0402 \_ \_ / \_ A 1.610,00 €  
 DALI-2, 1-10V, Push  
 0402 \_ \_ / \_ Z 1.730,00 €  
 Casambi

Materials  
 Diffuser: Polycarbonate. Horizontal rods: Steel.  
 Body: Aluminum Canopy: Steel.  
 Light Source and electronics  
 8 x LED 4,5 W 350 mA  
 Constant Current 350 mA  
 110-240V 50/60Hz

Packaging  
 2 Boxes  
 Total Vol 0,1558 m³  
 Gross weight 16,95 Kg Net weight 8,6 Kg

Notes  
 Without pressed-glass diffuser.  
 Configuration layout at [vibia.com](http://vibia.com)  
 Min. quantity, upcharge and extra lead time apply.

UNTIL STOCK RUNS OUT



|             |   |   |  |
|-------------|---|---|--|
| <b>0403</b> | <b>Finishes</b><br>● <b>04/ _ _ Black</b><br>(RAL 9005) | <b>LED temperature colour</b><br>/1_ 2700 K <br>CRI >90 3880 lm 121 lm/W | <b>Control</b><br><b>0403 _ / _ A</b> 1.525,00 €<br>DALI-2, 1-10V, Push<br><hr/> <b>0403 _ / _ Z</b> 1.645,00 €<br>Casambi |
|-------------|---|---|--|

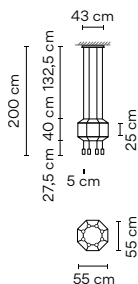

**Materials**  
 Diffuser: Polycarbonate. Horizontal rods: Steel.  
 Body: Aluminum Canopy: Steel.

**Light Source and electronics**  
 8 x LED 4,5 W 350 mA  
 Constant Current 350 mA  
 110~240V 50/60Hz

**Packaging**  
 2 Boxes  
 Total Vol 0,1558 m<sup>3</sup>  
 Gross weight 16,65 Kg Net weight 8,5 Kg

**Notes**  
 Without pressed-glass diffuser.  
**Configuration layout at vibia.com**  
 Min. quantity, upcharge and extra lead time apply.

**UNTIL STOCK RUNS OUT**



|             |   |   |  |
|-------------|---|---|--|
| <b>0404</b> | <b>Finishes</b><br>● <b>04/ _ _ Black</b><br>(RAL 9005) | <b>LED temperature colour</b><br>/1_ 2700 K <br>CRI >90 2910 lm 121 lm/W | <b>Control</b><br><b>0404 _ / _ A</b> 1.390,00 €<br>DALI-2, 1-10V, Push<br><hr/> <b>0404 _ / _ Z</b> 1.510,00 €<br>Casambi |
|-------------|---|---|--|

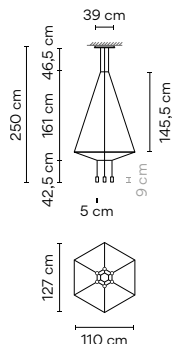

**Materials**  
 Diffuser: Polycarbonate. Horizontal rods: Steel.  
 Body: Aluminum Canopy: Steel.

**Light Source and electronics**  
 6 x LED 4,5 W 350 mA  
 Constant Current 350 mA  
 110~240V 50/60Hz

**Packaging**  
 2 Boxes  
 Total Vol 0,3245 m<sup>3</sup>  
 Gross weight 15,55 Kg Net weight 5,65 Kg

**Notes**  
 Without pressed-glass diffuser.  
**Configuration layout at vibia.com**  
 Min. quantity, upcharge and extra lead time apply.

**UNTIL STOCK RUNS OUT**



|             |   |   |  |
|-------------|---|---|--|
| <b>0405</b> | <b>Finishes</b><br>● <b>04/ _ _ Black</b><br>(RAL 9005) | <b>LED temperature colour</b><br>/1_ 2700 K <br>CRI >90 2910 lm 121 lm/W | <b>Control</b><br><b>0405 _ / _ A</b> 1.320,00 €<br>DALI-2, 1-10V, Push<br><hr/> <b>0405 _ / _ Z</b> 1.440,00 €<br>Casambi |
|-------------|---|---|--|

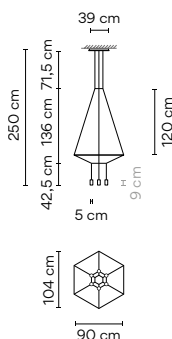

**Materials**  
 Diffuser: Polycarbonate. Horizontal rods: Steel.  
 Body: Aluminum Canopy: Steel.

**Light Source and electronics**  
 6 x LED 4,5 W 350 mA  
 Constant Current 350 mA  
 110~240V 50/60Hz

**Packaging**  
 2 Boxes  
 Total Vol 0,3245 m<sup>3</sup>  
 Gross weight 15,55 Kg Net weight 5,65 Kg

**Notes**  
 Without pressed-glass diffuser.  
**Configuration layout at vibia.com**  
 Min. quantity, upcharge and extra lead time apply.

**UNTIL STOCK RUNS OUT**



0406

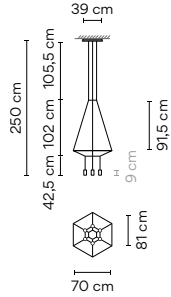

Finishes ● 04/ \_ \_ Black (RAL 9005)  
 LED temperature colour /1\_ 2700 K [D] CRI >90 2910 lm 121 lm/W

Control 0406 \_ \_ / \_ A 1.315,00 €  
 DALI-2, 1-10V, Push  
 0406 \_ \_ / \_ Z 1.435,00 €  
 Casambi

Materials  
 Diffuser: Polycarbonate. Horizontal rods: Steel.  
 Body: Aluminum Canopy: Steel.

Light Source and electronics  
 6 x LED 4,5 W 350 mA  
 Constant Current 350 mA  
 110-240V 50/60Hz

Packaging  
 2 Boxes  
 Total Vol 0,2100 m³  
 Gross weight 13,1 Kg Net weight 5,2 Kg

Notes  
 Without pressed-glass diffuser.  
**Configuration layout at vibia.com**  
 Min. quantity, upcharge and extra lead time apply.

UNTIL STOCK RUNS OUT



0407

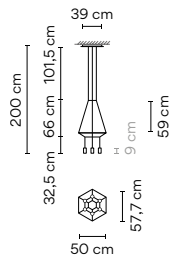

Finishes ● 04/ \_ \_ Black (RAL 9005)  
 LED temperature colour /1\_ 2700 K [D] CRI >90 2910 lm 121 lm/W

Control 0407 \_ \_ / \_ A 1.275,00 €  
 DALI-2, 1-10V, Push  
 0407 \_ \_ / \_ Z 1.395,00 €  
 Casambi

Materials  
 Diffuser: Polycarbonate. Horizontal rods: Steel.  
 Body: Aluminum Canopy: Steel.

Light Source and electronics  
 6 x LED 4,5 W 350 mA  
 Constant Current 350 mA  
 110-240V 50/60Hz

Packaging  
 2 Boxes  
 Total Vol 0,1558 m³  
 Gross weight 10 Kg Net weight 5,1 Kg

Notes  
 Without pressed-glass diffuser.  
**Configuration layout at vibia.com**  
 Min. quantity, upcharge and extra lead time apply.

UNTIL STOCK RUNS OUT



0408

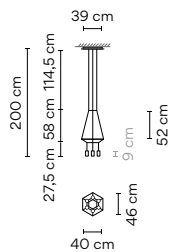

Finishes ● 04/ \_ \_ Black (RAL 9005)  
 LED temperature colour /1\_ 2700 K [D] CRI >90 2910 lm 121 lm/W

Control 0408 \_ \_ / \_ A 1.240,00 €  
 DALI-2, 1-10V, Push  
 0408 \_ \_ / \_ Z 1.360,00 €  
 Casambi

Materials  
 Diffuser: Polycarbonate. Horizontal rods: Steel.  
 Body: Aluminum Canopy: Steel.

Light Source and electronics  
 6 x LED 4,5 W 350 mA  
 Constant Current 350 mA  
 110-240V 50/60Hz

Packaging  
 2 Boxes  
 Total Vol 0,1238 m³  
 Gross weight 8,4 Kg Net weight 5 Kg

Notes  
 Without pressed-glass diffuser.  
**Configuration layout at vibia.com**  
 Min. quantity, upcharge and extra lead time apply.

UNTIL STOCK RUNS OUT



|             |   |   |   |
|-------------|---|---|---|
| <b>0409</b> | <b>Finishes</b><br>● <b>O4/ _ _ Black</b><br>(RAL 9005) | <b>LED temperature colour</b><br>/1_ 2700 K <br>CRI >90 1940 lm 121 lm/W | <b>Control</b><br><b>0409 _ _ / _ A</b> <span style="float: right;"><b>985,00 €</b></span><br>DALI-2, 1-10V, Push |
|             |   |   | <b>0409 _ _ / _ Z</b> <span style="float: right;"><b>1.105,00 €</b></span><br>Casambi                             |

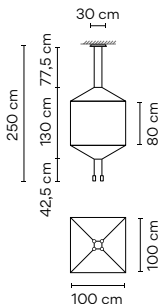

**Materials**  
 Diffuser: Polycarbonate. Horizontal rods: Steel.  
 Body: Aluminum Canopy: Steel.

**Light Source and electronics**  
 4 x LED 4,5 W 350 mA  
 Constant Current 350 mA  
 110~240V 50/60Hz

**Packaging**  
 2 Boxes  
 Total Vol 0,2100 m<sup>3</sup>  
 Gross weight 12,3 Kg Net weight 5,3 Kg

**Notes**  
 Without pressed-glass diffuser.  
**Configuration layout at vibia.com**  
 Min. quantity, upcharge and extra lead time apply.

**UNTIL STOCK RUNS OUT**



|             |   |   |   |
|-------------|---|---|---|
| <b>0410</b> | <b>Finishes</b><br>● <b>O4/ _ _ Black</b><br>(RAL 9005) | <b>LED temperature colour</b><br>/1_ 2700 K <br>CRI >90 1940 lm 121 lm/W | <b>Control</b><br><b>0410 _ _ / _ A</b> <span style="float: right;"><b>935,00 €</b></span><br>DALI-2, 1-10V, Push |
|             |   |   | <b>0410 _ _ / _ Z</b> <span style="float: right;"><b>1.055,00 €</b></span><br>Casambi                             |

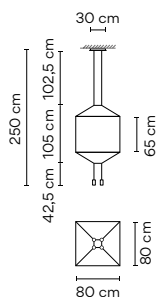

**Materials**  
 Diffuser: Polycarbonate. Horizontal rods: Steel.  
 Body: Aluminum Canopy: Steel.

**Light Source and electronics**  
 4 x LED 4,5 W 350 mA  
 Constant Current 350 mA  
 110~240V 50/60Hz

**Packaging**  
 2 Boxes  
 Total Vol 0,2100 m<sup>3</sup>  
 Gross weight 11,8 Kg Net weight 4,8 Kg

**Notes**  
 Without pressed-glass diffuser.  
**Configuration layout at vibia.com**  
 Min. quantity, upcharge and extra lead time apply.

**UNTIL STOCK RUNS OUT**



|             |   |   |   |
|-------------|---|---|---|
| <b>0411</b> | <b>Finishes</b><br>● <b>O4/ _ _ Black</b><br>(RAL 9005) | <b>LED temperature colour</b><br>/1_ 2700 K <br>CRI >90 1940 lm 121 lm/W | <b>Control</b><br><b>0411 _ _ / _ A</b> <span style="float: right;"><b>920,00 €</b></span><br>DALI-2, 1-10V, Push |
|             |   |   | <b>0411 _ _ / _ Z</b> <span style="float: right;"><b>1.040,00 €</b></span><br>Casambi                             |

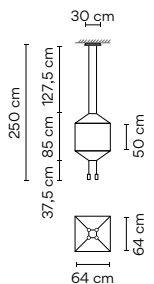

**Materials**  
 Diffuser: Polycarbonate. Horizontal rods: Steel.  
 Body: Aluminum Canopy: Steel.

**Light Source and electronics**  
 4 x LED 4,5 W 350 mA  
 Constant Current 350 mA  
 110~240V 50/60Hz

**Packaging**  
 2 Boxes  
 Total Vol 0,1558 m<sup>3</sup>  
 Gross weight 11,4 Kg Net weight 4,7 Kg

**Notes**  
 Without pressed-glass diffuser.  
**Configuration layout at vibia.com**  
 Min. quantity, upcharge and extra lead time apply.

**UNTIL STOCK RUNS OUT**



0412

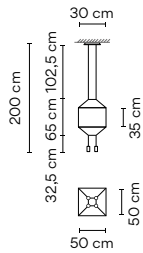

Finishes ● 04/ \_ \_ Black (RAL 9005)  
 LED temperature colour /1\_ 2700 K [D] CRI >90 1940 lm 121 lm/W

Control 0412 \_ \_ / \_ A 950,00 €  
 DALI-2, 1-10V, Push  
 0412 \_ \_ / \_ Z 1.070,00 €  
 Casambi

Materials  
 Diffuser: Polycarbonate. Horizontal rods: Steel.  
 Body: Aluminum Canopy: Steel.

Light Source and electronics  
 4 x LED 4,5 W 350 mA  
 Constant Current 350 mA  
 110-240V 50/60Hz

Packaging  
 2 Boxes  
 Total Vol 0,1558 m<sup>3</sup>  
 Gross weight 11,2 Kg Net weight 4,6 Kg

Notes  
 Without pressed-glass diffuser.  
**Configuration layout at vibia.com**  
 Min. quantity, upcharge and extra lead time apply.

UNTIL STOCK RUNS OUT



0413

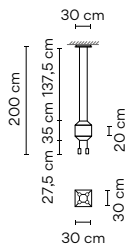

Finishes ● 04/ \_ \_ Black (RAL 9005)  
 LED temperature colour /1\_ 2700 K [D] CRI >90 1940 lm 121 lm/W

Control 0413 \_ \_ / \_ A 925,00 €  
 DALI-2, 1-10V, Push  
 0413 \_ \_ / \_ Z 1.045,00 €  
 Casambi

Materials  
 Diffuser: Polycarbonate. Horizontal rods: Steel.  
 Body: Aluminum Canopy: Steel.

Light Source and electronics  
 4 x LED 4,5 W 350 mA  
 Constant Current 350 mA  
 110-240V 50/60Hz

Packaging  
 2 Boxes  
 Total Vol 0,1238 m<sup>3</sup>  
 Gross weight 7 Kg Net weight 4,5 Kg

Notes  
 Without pressed-glass diffuser.  
**Configuration layout at vibia.com**  
 Min. quantity, upcharge and extra lead time apply.

UNTIL STOCK RUNS OUT



# Wireflow Lineal

Design by Arik Levy

Crafted of black, electrical cables and lacquered metal rods, Linear traces an airy, two-dimensional outline that lends it a powerful graphic presence. The slim cables are tipped with LED terminals and can be customised.

## Pendants

**0320**

57 cm

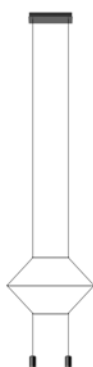

**0325**

155 cm

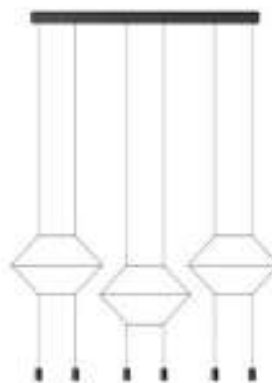

**0330**

275 cm

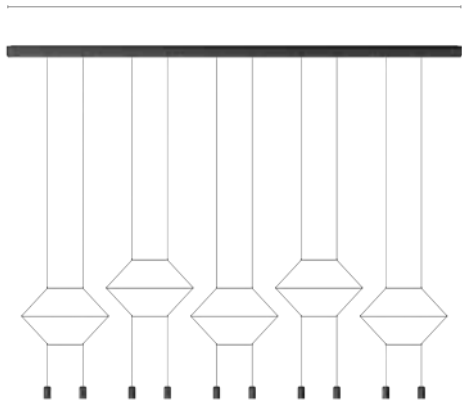

**0332**

275 cm

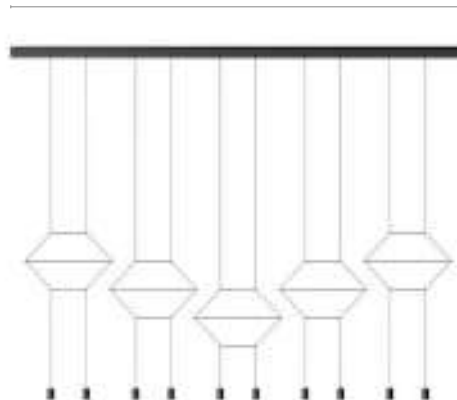

**0338**

145 cm

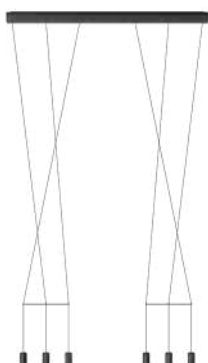

**0340**

205 cm

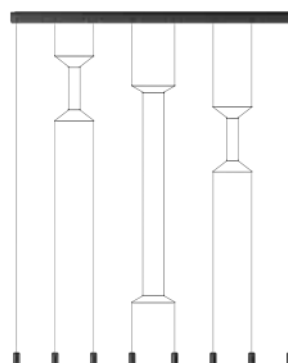



Each project is unique. Visit [vibia.com](http://vibia.com) and chose among multiple compositions designed and adapted to your project needs.

Personalise your own Wireflow composition quick and easy at [vibia.com](http://vibia.com)



Without pressed-glass diffuser.

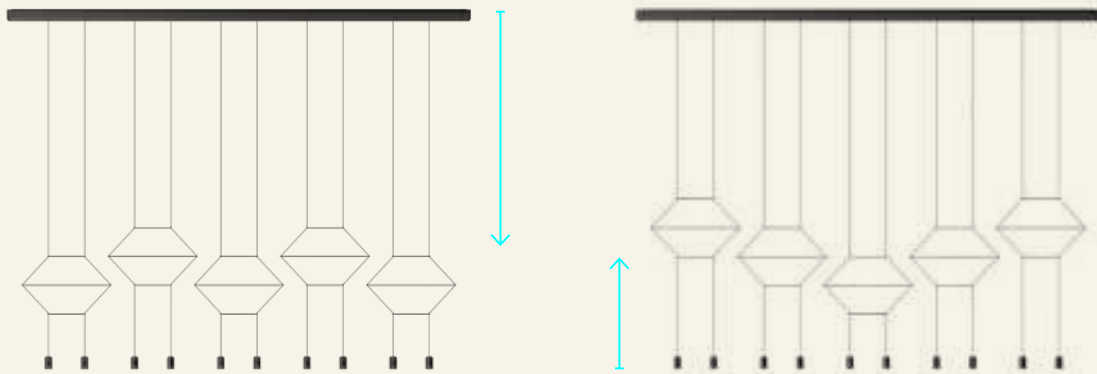

0320

Finishes  
 ● 04/ \_\_ Black (RAL 9005)

LED temperature colour  
 /1\_ 2700 K [D] CRI >90 970 lm 121 lm/W  
 /2\_ 3000 K [E] CRI >90 970 lm 121 lm/W  
 /3\_ 3500 K [E] CRI >90 1000,6 lm 125,1 lm/W

Control  
 0320 \_\_ / \_ 1 725,00 € DALI  
 0320 \_\_ / \_ B 690,00 € 1-10V, Push  
 0320 \_\_ / \_ Z 810,00 € Casambi

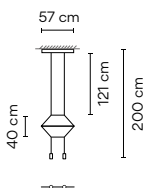

Materials  
 Diffuser: Polycarbonate. Horizontal rods: Steel.  
 Body: Aluminum. Canopy: Aluminum.



Light Source and electronics  
 2 x LED 4,5 W 350 mA  
 Constant Current 350 mA  
 110-240V 50/60Hz

Packaging  
 1 Box 0,20 x 0,075 x 0,70 m  
 Vol 0,0150 m³  
 Gross weight 5,1 Kg Net weight 2,6 Kg



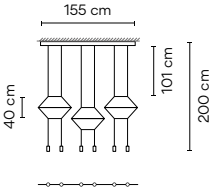

Notes  
 Linear canopy  
 LED [Symbol] IP20 CE EAC [Symbol] Bi-volt

**0325**







|  |   |  |                   |
|--|---|--|-------------------|
| <b>Finishes</b><br>● <b>04/</b> __ Black<br>(RAL 9005) | <b>LED temperature colour</b><br>/1_ 2700 K <br>CRI >90 2910 lm 121 lm/W | <b>Control</b><br><b>0325</b> __ / _ 1<br>DALI | <b>1.745,00 €</b> |
|  | /2_ 3000 K <br>CRI >90 2910 lm 121 lm/W                                  | <b>0325</b> __ / _ B<br>1-10V, Push            | <b>1.660,00 €</b> |
|  | /3_ 3500 K <br>CRI >90 3001,8 lm 125,1 lm/W                              | <b>0325</b> __ / _ Z<br>Casambi                | <b>1.780,00 €</b> |

---

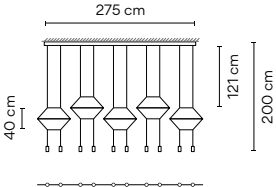



|  |   |
|--|---|
| <b>Materials</b><br>Diffuser: Polycarbonate. Horizontal rods: Steel.<br>Body: Aluminum. Canopy: Aluminum.  | <b>Packaging</b><br>1 Box 0,20 x 0,075 x 2,30 m<br>Vol 0,0345 m <sup>3</sup><br>Gross weight 8 Kg Net weight 4,5 Kg   |
| <b>Light Source and electronics</b><br>6 x LED 4,5 W 350 mA<br>Constant Current 350 mA<br>110~240V 50/60Hz | <b>Notes</b><br>Linear canopy<br>     |

**0330**





|  |   |  |                   |
|--|---|--|-------------------|
| <b>Finishes</b><br>● <b>04/</b> __ Black<br>(RAL 9005) | <b>LED temperature colour</b><br>/1_ 2700 K <br>CRI >90 4850 lm 121 lm/W | <b>Control</b><br><b>0330</b> __ / _ 1<br>DALI | <b>2.600,00 €</b> |
|  | /2_ 3000 K <br>CRI >90 4850 lm 121 lm/W                                  | <b>0330</b> __ / _ B<br>1-10V, Push            | <b>2.475,00 €</b> |
|  | /3_ 3500 K <br>CRI >90 5003,0 lm 125,1 lm/W                             | <b>0330</b> __ / _ Z<br>Casambi                | <b>2.595,00 €</b> |

---



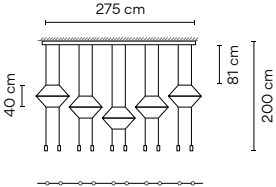

|   |   |
|---|---|
| <b>Materials</b><br>Diffuser: Polycarbonate. Horizontal rods: Steel.<br>Body: Aluminum. Canopy: Aluminum.   | <b>Packaging</b><br>1 Box 0,20 x 0,075 x 3,30 m<br>Vol 0,0495 m <sup>3</sup><br>Gross weight 9,5 Kg Net weight 5,0 Kg   |
| <b>Light Source and electronics</b><br>10 x LED 4,5 W 700 mA<br>Constant Current 350 mA<br>220~240V 50/60Hz | <b>Notes</b><br>Linear canopy<br>     |

**0332**



|  |   |  |                   |
|--|---|--|-------------------|
| <b>Finishes</b><br>● <b>04/</b> __ Black<br>(RAL 9005) | <b>LED temperature colour</b><br>/1_ 2700 K <br>CRI >80 4902,7 lm 109 lm/W | <b>Control</b><br><b>0332</b> __ / _ 1<br>DALI | <b>2.600,00 €</b> |
|  |   | <b>0332</b> __ / _ B<br>1-10V, Push            | <b>2.475,00 €</b> |
|  |   | <b>0332</b> __ / _ Z<br>Casambi                | <b>2.595,00 €</b> |

---

|   |   |
|---|---|
| <b>Materials</b><br>Diffuser: Polycarbonate. Horizontal rods: Steel.<br>Body: Aluminum. Canopy: Aluminum.   | <b>Packaging</b><br>1 Box 0,20 x 0,075 x 3,30 m<br>Vol 0,0345 m <sup>3</sup><br>Gross weight 9,2 Kg Net weight 8,3 Kg   |
| <b>Light Source and electronics</b><br>10 x LED 4,5 W 700 mA<br>Constant Current 350 mA<br>220~240V 50/60Hz | <b>Notes</b><br>Linear canopy.<br><b>UNTIL STOCK RUNS OUT</b><br>     |

0338

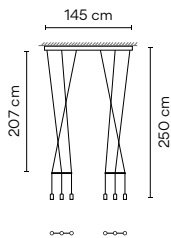

Finishes  
 ● 04/ \_ \_ Black (RAL 9005)

LED temperature colour  
 /1 \_ 2700 K CRI >90 2910 lm 121 lm/W  
 /3 \_ 3500 K CRI >90 3001,8 lm 125,1 lm/W

Control  
 0338 \_ \_ / \_ 1 1.815,00 €  
 DALI  
 0338 \_ \_ / \_ B 1.725,00 €  
 1-10V, Push  
 0338 \_ \_ / \_ Z 1.845,00 €  
 Casambi

Materials

Diffuser: Polycarbonate. Horizontal rods: Steel.  
 Body: Aluminum. Canopy: Aluminum.

Light Source and electronics

6 x LED 4,5 W 350 mA  
 Constant Current 350 mA  
 110~240V 50/60Hz

Packaging

1 Box 0,20 x 0,075 x 3,30 m  
 Vol 0,0495 m<sup>3</sup>  
 Gross weight 9,5 Kg Net weight 5,0 Kg

Notes

Linear canopy



0340

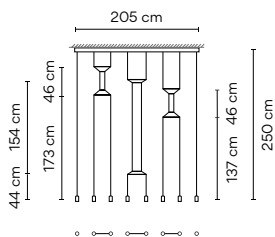

Finishes  
 ● 04/ \_ \_ Black (RAL 9005)

LED temperature colour  
 /1 \_ 2700 K CRI >90 3922 lm 109 lm/W

Control  
 0340 \_ \_ / \_ 1 2.115,00 €  
 DALI  
 0340 \_ \_ / \_ B 2.010,00 €  
 1-10V, Push  
 0340 \_ \_ / \_ Z 2.130,00 €  
 Casambi

Materials

Diffuser: Polycarbonate. Horizontal rods: Steel.  
 Body: Aluminum. Canopy: Aluminum.

Light Source and electronics

8 x LED 4,5 W 700 mA  
 Constant Current 350 mA  
 220~240V 50/60Hz

Packaging

1 Box 0,20 x 0,075 x 2,30 m  
 Vol 0,0345 m<sup>3</sup>  
 Gross weight 10,2 Kg Net weight 9,3 Kg

Notes

Linear canopy.

UNTIL STOCK RUNS OUT

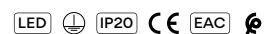

# Wireflow FreeForm

Design by Arik Levy

Crafted of lean, electrical cables that trace airy, geometric outlines, Free Form is equal parts light and fluidity. The customisable fixture features endlessly adjustable shapes and heights, LED light points, and a wall or ceiling canopy to suit any space.

---

## Pendants

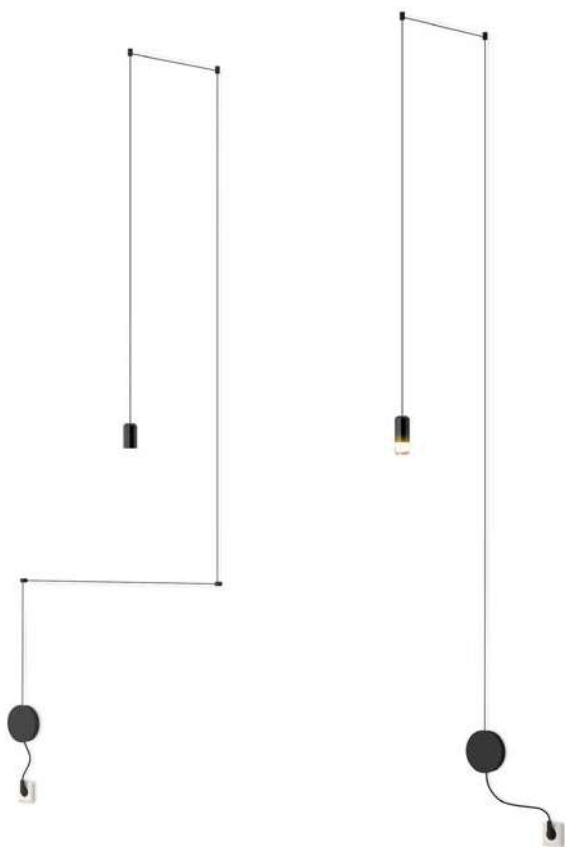

1160 | 10 / 1A | \_18

Model | Finish | LED temperature colour | Control | Electrical connection  
Only for pendants

Each project is unique. Visit [vibia.com](http://vibia.com) and chose among multiple compositions designed and adapted to your project needs.

Personalise your own Wireflow composition quick and easy at [vibia.com](http://vibia.com)



Pressed-glass diffuser.  
\*Without pressed-glass diffuser.

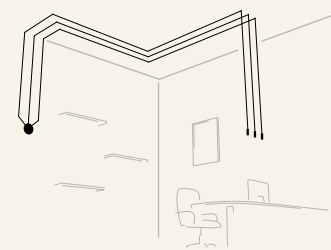
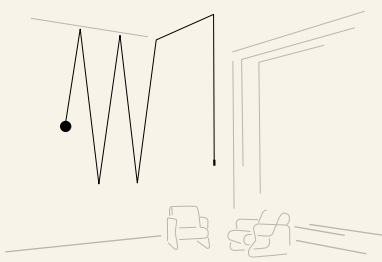
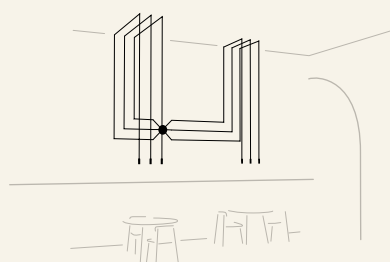

0345

Finishes  
● 04/ \_\_ Black (RAL 9005)

LED temperature colour  
/1\_ 2700 K CRI >90 485 lm 121 lm/W  
/2\_ 3000 K CRI >90 485 lm 121 lm/W  
/3\_ 3500 K CRI >90 500,3 lm 125,1 lm/W

Control  
0345 \_\_ / \_ 1 480,00 € DALI-2  
0345 \_\_ / \_ B 455,00 € 1-10V, Push  
0345 \_\_ / \_ Z 575,00 € Casambi

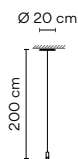

Materials  
Diffuser: Pressed-glass. Body: Aluminum. Canopy: Steel.

Light Source and electronics  
1 x LED 4,5 W 700 mA  
Constant Current 350 mA  
100~240V 50/60Hz

Packaging  
1 Box 0,25 x 0,42 x 0,42 m  
Vol 0,0441 m<sup>3</sup>  
Gross weight 2,6 Kg Net weight 2,34 Kg

Notes  
Pressed-glass diffuser.  
Extra cable length. 16,00 €/m

Bi-volt

Electrical connection  
Surface  
\_18 Free Wire  
\_23 Built-in  
\_31 Remote  
\_32 Remote  
Micro for plaster ceilings  
XXS for all types of drop ceilings

**0347** Finishes **04/** \_\_ Black (RAL 9005) LED temperature colour **/1\_** 2700 K CRI >80 490 lm 109 lm/W Control **0347** \_\_ / \_ 5 Push **365,00 €**

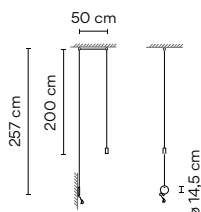

**Materials**  
Diffuser: Polycarbonate. Body: Aluminum.  
Canopy: Steel.

**Light Source and electronics**  
1 x LED 4,5 W 350 mA  
Constant Current 350 mA  
100~240V 50/60Hz

**Packaging**  
1 Box 0,13 x 0,20 x 0,20 m  
Vol 0,0055 m<sup>3</sup>  
Gross weight 1,5 Kg Net weight 1,35 Kg

**Notes**  
Electric cable 2,5 m. With plug.  
Dimmer push button on the wall plate.  
Without pressed-glass diffuser.



**0348** Finishes **04/** \_\_ Black (RAL 9005) LED temperature colour **/1\_** 2700 K CRI >80 490 lm 109 lm/W Control **0348** \_\_ / \_ 5 Push **440,00 €**

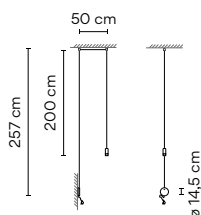

**Materials**  
Diffuser: Pressed-glass. Body: Aluminum.  
Canopy: Steel.

**Light Source and electronics**  
1 x LED 4,5 W 350 mA  
Constant Current 350 mA  
100~240V 50/60Hz

**Packaging**  
1 Box 0,26 x 0,26 x 0,26 m  
Vol 0,0175 m<sup>3</sup>  
Gross weight 1,9 Kg Net weight 1,71 Kg

**Notes**  
Electric cable 2,5 m. With plug.  
Dimmer push button on the wall plate.  
Without pressed-glass diffuser.



**0349** Finishes **04/** \_\_ Black (RAL 9005) LED temperature colour **/1\_** 2700 K CRI >90 970 lm 121 lm/W **/2\_** 3000 K CRI >90 970 lm 121 lm/W **/3\_** 3500 K CRI >90 1000,6 lm 125,1 lm/W Control **0349** \_\_ / A DALI-2, 1-10V, Push **700,00 €** **0349** \_\_ / Z Casambi **820,00 €**

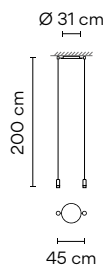

**Materials**  
Diffuser: Pressed-glass. Body: Aluminum.  
Canopy: Steel.

**Light Source and electronics**  
2 x LED 4,5 W 350 mA  
Constant Current 350 mA  
100~240V 50/60Hz

**Packaging**  
1 Box 0,27 x 0,60 x 0,60 m  
Vol 0,0972 m<sup>3</sup>  
Gross weight 4,6 Kg Net weight 4,14 Kg

**Notes**  
Pressed-glass diffuser.  
**UNTIL STOCK RUNS OUT**



0350

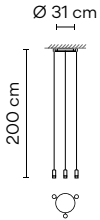

Finishes  
 ● 04/ \_ \_ Black (RAL 9005)

LED temperature colour  
 /1 \_ 2700 K [D] CRI >90 1455 lm 121 lm/W  
 /2 \_ 3000 K [E] CRI >90 1455 lm 121 lm/W  
 /3 \_ 3500 K [E] CRI >90 1500,9 lm 125,1 lm/W

Control  
 0350 \_ \_ / \_ A 875,00 €  
 DALI-2, 1-10V, Push  
 0350 \_ \_ / \_ Z 995,00 €  
 Casambi

Materials  
 Diffuser: Pressed-glass. Body: Aluminum.  
 Canopy: Steel.

Light Source and electronics  
 3 x LED 4,5 W 350 mA  
 Constant Current 350 mA  
 100~240V 50/60Hz

Packaging  
 1 Box 0,27 x 0,60 x 0,60 m  
 Vol 0,0972 m<sup>3</sup>  
 Gross weight 5,2 Kg Net weight 4,68 Kg

Notes  
 Pressed-glass diffuser.  
**UNTIL STOCK RUNS OUT**



0351

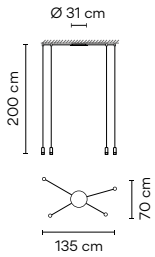

Finishes  
 ● 04/ \_ \_ Black (RAL 9005)

LED temperature colour  
 /1 \_ 2700 K [D] CRI >90 1940 lm 121 lm/W  
 /2 \_ 3000 K [E] CRI >90 1940 lm 121 lm/W  
 /3 \_ 3500 K [E] CRI >90 2001,2 lm 125,1 lm/W

Control  
 0351 \_ \_ / \_ A 1.090,00 €  
 DALI, 1-10V, Push  
 0351 \_ \_ / \_ Z 1.210,00 €  
 Casambi

Materials  
 Diffuser: Pressed-glass. Body: Aluminum.  
 Canopy: Steel.

Light Source and electronics  
 4 x LED 4,5 W 350 mA  
 Constant Current 350 mA  
 100~240V 50/60Hz

Packaging  
 1 Box 0,27 x 0,60 x 0,60 m  
 Vol 0,0972 m<sup>3</sup>  
 Gross weight 5,6 Kg Net weight 5,04 Kg

Notes  
 Pressed-glass diffuser.  
**UNTIL STOCK RUNS OUT**



0353

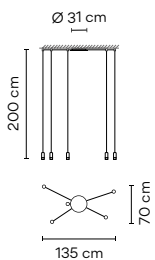

Finishes  
 ● 04/ \_ \_ Black (RAL 9005)

LED temperature colour  
 /1 \_ 2700 K [D] CRI >90 2425 lm 121 lm/W  
 /2 \_ 3000 K [E] CRI >90 2425 lm 121 lm/W  
 /3 \_ 3500 K [E] CRI >90 2501,5 lm 125,1 lm/W

Control  
 0353 \_ \_ / \_ A 1.215,00 €  
 DALI, 1-10V, Push  
 0353 \_ \_ / \_ Z 1.335,00 €  
 Casambi

Materials  
 Diffuser: Pressed-glass. Body: Aluminum.  
 Canopy: Steel.

Light Source and electronics  
 5 x LED 4,5 W 350 mA  
 Constant Current 350 mA  
 100~240V 50/60Hz

Packaging  
 1 Box 0,27 x 0,60 x 0,60 m  
 Vol 0,0972 m<sup>3</sup>  
 Gross weight 6,1 Kg Net weight 5,49 Kg

Notes  
 Pressed-glass diffuser.  
**UNTIL STOCK RUNS OUT**



**0355**

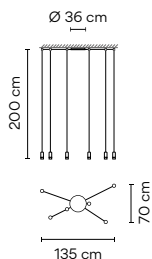

**Finishes**  
 ● **04/** \_\_ Black (RAL 9005)

**LED temperature colour**  
 /1\_ 2700 K **D** >90 2910 lm 121 lm/W  
 /2\_ 3000 K **E** >90 2910 lm 121 lm/W  
 /3\_ 3500 K **E** >90 3001,8 lm 125,1 lm/W

**Control**  
**0355** \_\_ / \_\_ A 1.465,00 €  
 DALI, 1-10V, Push  
**0355** \_\_ / \_\_ Z 1.585,00 €  
 Casambi

**Materials**  
 Diffuser: Pressed-glass. Body: Aluminum.  
 Canopy: Steel.

**Light Source and electronics**  
 6 x LED 4,5 W 350 mA  
 Constant Current 350 mA  
 100~240V 50/60Hz

**Packaging**  
 1 Box 0,27 x 0,60 x 0,60 m  
 Vol 0,0972 m<sup>3</sup>  
 Gross weight 6,7 Kg Net weight 6,03 Kg

**Notes**  
 Pressed-glass diffuser.  
**UNTIL STOCK RUNS OUT**

LED IP20 CE EAC Bi-volt

**0356**

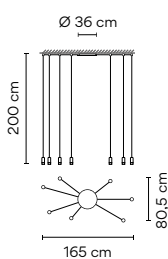

**Finishes**  
 ● **04/** \_\_ Black (RAL 9005)

**LED temperature colour**  
 /1\_ 2700 K **D** >90 3395 lm 121 lm/W  
 /2\_ 3000 K **E** >90 3395 lm 121 lm/W  
 /3\_ 3500 K **E** >90 3502,1 lm 125,1 lm/W

**Control**  
**0356** \_\_ / \_\_ A 1.795,00 €  
 DALI, 1-10V, Push  
**0356** \_\_ / \_\_ Z 1.915,00 €  
 Casambi

**Materials**  
 Diffuser: Pressed-glass. Body: Aluminum.  
 Canopy: Steel.

**Light Source and electronics**  
 7 x LED 4,5 W 350 mA  
 Constant Current 350 mA  
 100~240V 50/60Hz

**Packaging**  
 1 Box 0,27 x 0,60 x 0,60 m  
 Vol 0,0972 m<sup>3</sup>  
 Gross weight 7,9 Kg Net weight 7,11 Kg

**Notes**  
 Pressed-glass diffuser.  
**UNTIL STOCK RUNS OUT**

LED IP20 CE EAC Bi-volt

**0358**

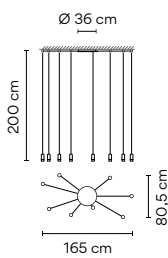

**Finishes**  
 ● **04/** \_\_ Black (RAL 9005)

**LED temperature colour**  
 /1\_ 2700 K **D** >90 3880 lm 121 lm/W  
 /2\_ 3000 K **E** >90 3880 lm 121 lm/W  
 /3\_ 3500 K **E** >90 4002,4 lm 125,1 lm/W

**Control**  
**0358** \_\_ / \_\_ A 1.950,00 €  
 DALI, 1-10V, Push  
**0358** \_\_ / \_\_ Z 2.070,00 €  
 Casambi

**Materials**  
 Diffuser: Pressed-glass. Body: Aluminum.  
 Canopy: Steel.

**Light Source and electronics**  
 8 x LED 4,5 W 350 mA  
 Constant Current 350 mA  
 100~240V 50/60Hz

**Packaging**  
 1 Box 0,27 x 0,60 x 0,60 m  
 Vol 0,0972 m<sup>3</sup>  
 Gross weight 8,4 Kg Net weight 7,56 Kg

**Notes**  
 Pressed-glass diffuser.  
**UNTIL STOCK RUNS OUT**

LED IP20 CE EAC Bi-volt



1160 10 / 1A \_18

Model  
Finish  
LED temperature colour  
Control  
Electrical connection  
Only for pendants

0360

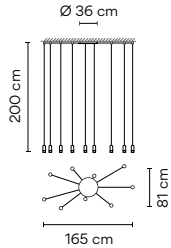

| Finishes                   | LED temperature colour                    | Control                          |            |
|----------------------------|---|----------------------------------|------------|
| ● 04/ _ _ Black (RAL 9005) | /1 _ 2700 K  CRI >90 4365 lm 121 lm/W     | 0360 _ _ / _ A DALI, 1-10V, Push | 2.110,00 € |
|                            | /2 _ 3000 K  CRI >90 4365 lm 121 lm/W     | 0360 _ _ / _ Z Casambi           | 2.230,00 € |
|                            | /3 _ 3500 K  CRI >90 4502,7 lm 125,1 lm/W |                                  |            |

**Materials**

Diffuser: Pressed-glass. Body: Aluminum. Canopy: Steel.

**Light Source and electronics**

9 x LED 4,5 W 350 mA  
Constant Current 350 mA  
100~240V 50/60Hz

**Packaging**

1 Box 0,27 x 0,60 x 0,60 m  
Vol 0,0972 m<sup>3</sup>  
Gross weight 9,1 Kg Net weight 8,19 Kg

**Notes**

Pressed-glass diffuser.

**UNTIL STOCK RUNS OUT**

LED IP20

0361

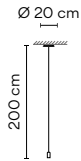

| Finishes                   | LED temperature colour                    | Control                    |          |
|----------------------------|---|----------------------------|----------|
| ● 04/ _ _ Black (RAL 9005) | /1 _ 2700 K  CRI >90 485 lm 121 lm/W      | 0361 _ _ / _ 1 DALI        | 400,00 € |
|                            | /2 _ 3000 K  CRI >90 485 lm 121 lm/W      | 0361 _ _ / _ B 1-10V, Push | 380,00 € |
|                            | /3 _ 3500 K  CRI >90 500,3 lm 125,10 lm/W | 0361 _ _ / _ Z Casambi     | 500,00 € |

**Materials**

Diffuser: Polycarbonate. Body: Aluminum. Canopy: Steel.

**Light Source and electronics**

1 x LED 4,5 W 700 mA  
Constant Current 350 mA  
100~240V 50/60Hz

**Packaging**

1 Box 0,25 x 0,42 x 0,42 m  
Vol 0,0441 m<sup>3</sup>  
Gross weight 2,6 Kg Net weight 2,34 Kg

**Notes**

Without pressed-glass diffuser.

Additional cable length personalisation  
**16,00 €/m**

LED IP20

**Electrical connection**

Surface  
\_18 Free Wire  
\_23 Built-in  
\_31 Remote Micro for plaster ceilings  
\_32 Remote XXS for all types of drop ceilings

0362

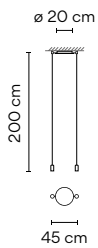

| Finishes                   | LED temperature colour               | Control                            |          |
|----------------------------|--------------------------------------|------------------------------------|----------|
| ● 04/ _ _ Black (RAL 9005) | /1 _ 2700 K  CRI >80 980 lm 109 lm/W | 0362 _ _ / _ A DALI-2, 1-10V, Push | 550,00 € |
|                            |                                      | 0362 _ _ / _ Z Casambi             | 670,00 € |

**Materials**

Diffuser: Polycarbonate. Body: Aluminum. Canopy: Steel.

**Light Source and electronics**

2 x LED 4,5 W 350 mA  
Constant Current 350 mA  
100~240V 50/60Hz

**Packaging**

1 Box 0,27 x 0,60 x 0,60 m  
Vol 0,0972 m<sup>3</sup>  
Gross weight 4,6 Kg Net weight 4,14 Kg

**Notes**

Without pressed-glass diffuser.

**UNTIL STOCK RUNS OUT**

LED IP20



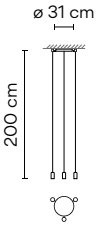



**0363**



|  |   |  |                            |
|--|---|--|----------------------------|
| <b>Finishes</b><br>● <b>04/</b> __ Black<br>(RAL 9005) | <b>LED temperature colour</b><br>/1_ 2700 K <br>CRI >80 1471 lm 109 lm/W | <b>Control</b><br><b>0363</b> __ / __ A<br>DALI-2, 1-10V, Push<br><hr/> <b>0363</b> __ / __ Z<br>Casambi | 650,00 €<br><hr/> 770,00 € |
|--|---|--|----------------------------|

---

|  |   |
|--|---|
| <b>Materials</b><br>Diffuser: Polycarbonate. Body: Aluminum.<br>Canopy: Steel.                             | <b>Packaging</b><br>1 Box 0,27 x 0,60 x 0,60 m<br>Vol 0,0972 m <sup>3</sup><br>Gross weight 5,2 Kg Net weight 4,68 Kg |
| <b>Light Source and electronics</b><br>3 x LED 4,5 W 350 mA<br>Constant Current 350 mA<br>100~240V 50/60Hz | <b>Notes</b><br>Without pressed-glass diffuser.<br><b>UNTIL STOCK RUNS OUT</b>  |





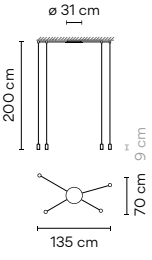

**0364**



|  |   |  |                            |
|--|---|--|----------------------------|
| <b>Finishes</b><br>● <b>04/</b> __ Black<br>(RAL 9005) | <b>LED temperature colour</b><br>/1_ 2700 K <br>CRI >80 1471 lm 109 lm/W | <b>Control</b><br><b>0364</b> __ / __ A<br>DALI-2, 1-10V, Push<br><hr/> <b>0364</b> __ / __ Z<br>Casambi | 790,00 €<br><hr/> 910,00 € |
|--|---|--|----------------------------|

---

|  |   |
|--|---|
| <b>Materials</b><br>Diffuser: Polycarbonate. Body: Aluminum.<br>Canopy: Steel.                             | <b>Packaging</b><br>1 Box 0,27 x 0,60 x 0,60 m<br>Vol 0,0972 m <sup>3</sup><br>Gross weight 5,6 Kg Net weight 5,04 Kg |
| <b>Light Source and electronics</b><br>4 x LED 4,5 W 350 mA<br>Constant Current 350 mA<br>100~240V 50/60Hz | <b>Notes</b><br>Without pressed-glass diffuser.<br><b>UNTIL STOCK RUNS OUT</b>  |





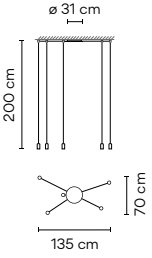

**0365**



|  |   |  |                            |
|--|---|--|----------------------------|
| <b>Finishes</b><br>● <b>04/</b> __ Black<br>(RAL 9005) | <b>LED temperature colour</b><br>/1_ 2700 K <br>CRI >80 2451 lm 109 lm/W | <b>Control</b><br><b>0365</b> __ / __ A<br>DALI-2, 1-10V, Push<br><hr/> <b>0365</b> __ / __ Z<br>Casambi | 840,00 €<br><hr/> 960,00 € |
|--|---|--|----------------------------|

---

|  |  |
|--|--|
| <b>Materials</b><br>Diffuser: Polycarbonate. Body: Aluminum.<br>Canopy: Steel.                             | <b>Packaging</b><br>1 Box 0,27 x 0,60 x 0,60 m<br>Vol 0,0972 m <sup>3</sup><br>Gross weight 5,04 Kg Net weight 5,49 Kg |
| <b>Light Source and electronics</b><br>5 x LED 4,5 W 350 mA<br>Constant Current 350 mA<br>100~240V 50/60Hz | <b>Notes</b><br>Without pressed-glass diffuser.<br><b>UNTIL STOCK RUNS OUT</b>   |





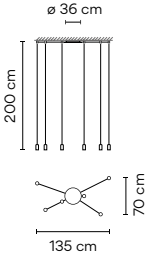

**0366**



|  |   |  |                                |
|--|---|--|--------------------------------|
| <b>Finishes</b><br>● <b>04/</b> __ Black<br>(RAL 9005) | <b>LED temperature colour</b><br>/1_ 2700 K <br>CRI >80 2942 lm 109 lm/W | <b>Control</b><br><b>0366</b> __ / __ A<br>DALI-2, 1-10V, Push<br><hr/> <b>0366</b> __ / __ Z<br>Casambi | 1.040,00 €<br><hr/> 1.160,00 € |
|--|---|--|--------------------------------|

---

|  |   |
|--|---|
| <b>Materials</b><br>Diffuser: Polycarbonate. Body: Aluminum.<br>Canopy: Steel.                             | <b>Packaging</b><br>1 Box 0,27 x 0,60 x 0,60 m<br>Vol 0,0972 m <sup>3</sup><br>Gross weight 6,7 Kg Net weight 6,03 Kg |
| <b>Light Source and electronics</b><br>6 x LED 4,5 W 350 mA<br>Constant Current 350 mA<br>100~240V 50/60Hz | <b>Notes</b><br>Without pressed-glass diffuser.<br><b>UNTIL STOCK RUNS OUT</b>  |

0367

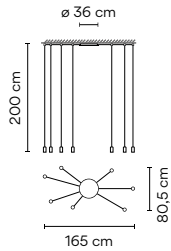

|   |   |   |            |
|---|---|---|------------|
| <b>Finishes</b><br>● 04/ _ _ Black (RAL 9005) | <b>LED temperature colour</b><br>/1_ 2700 K<br>CRI >80 3432 lm 109 lm/W | <b>Control</b><br>0367 _ _ / _ A<br>DALI-2, 1-10V, Push | 1.270,00 € |
|   |   | 0367 _ _ / _ Z<br>Casambi                               | 1.390,00 € |

**Materials**

Diffuser: Polycarbonate. Body: Aluminum.  
 Canopy: Steel.

**Light Source and electronics**

7 x LED 4,5 W 350 mA  
 Constant Current 350 mA  
 100~240V 50/60Hz

**Packaging**

1 Box 0,27 x 0,60 x 0,60 m  
 Vol 0,0972 m<sup>3</sup>  
 Gross weight 7,9 Kg Net weight 7,11 Kg

**Notes**

Without pressed-glass diffuser.

**UNTIL STOCK RUNS OUT**



0368

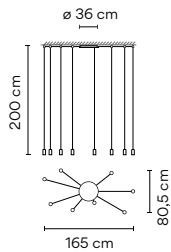

|   |   |   |            |
|---|---|---|------------|
| <b>Finishes</b><br>● 04/ _ _ Black (RAL 9005) | <b>LED temperature colour</b><br>/1_ 2700 K<br>CRI >80 3922 lm 109 lm/W | <b>Control</b><br>0368 _ _ / _ A<br>DALI-2, 1-10V, Push | 1.350,00 € |
|   |   | 0368 _ _ / _ Z<br>Casambi                               | 1.470,00 € |

**Materials**

Diffuser: Polycarbonate. Body: Aluminum.  
 Canopy: Steel.

**Light Source and electronics**

8 x LED 4,5 W 350 mA  
 Constant Current 350 mA  
 100~240V 50/60Hz

**Packaging**

1 Box 0,27 x 0,60 x 0,60 m  
 Vol 0,0972 m<sup>3</sup>  
 Gross weight 8,4 Kg Net weight 7,56 Kg

**Notes**

Without pressed-glass diffuser.

**UNTIL STOCK RUNS OUT**



0369

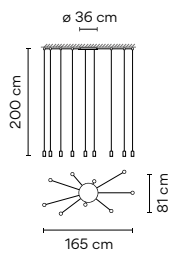

|   |   |   |            |
|---|---|---|------------|
| <b>Finishes</b><br>● 04/ _ _ Black (RAL 9005) | <b>LED temperature colour</b><br>/1_ 2700 K<br>CRI >80 4412 lm 109 lm/W | <b>Control</b><br>0369 _ _ / _ A<br>DALI-2, 1-10V, Push | 1.435,00 € |
|   |   | 0369 _ _ / _ Z<br>Casambi                               | 1.555,00 € |

**Materials**

Diffuser: Polycarbonate. Body: Aluminum.  
 Canopy: Steel.

**Light Source and electronics**

9 x LED 4,5 W 350 mA  
 Constant Current 350 mA  
 100~240V 50/60Hz

**Packaging**

1 Box 0,27 x 0,60 x 0,60 m  
 Vol 0,0972 m<sup>3</sup>  
 Gross weight 9,1 Kg Net weight 8,19 Kg

**Notes**

Without pressed-glass diffuser.

**UNTIL STOCK RUNS OUT**



# Composing pendants

Next sketches are composed by one or more compositions

---

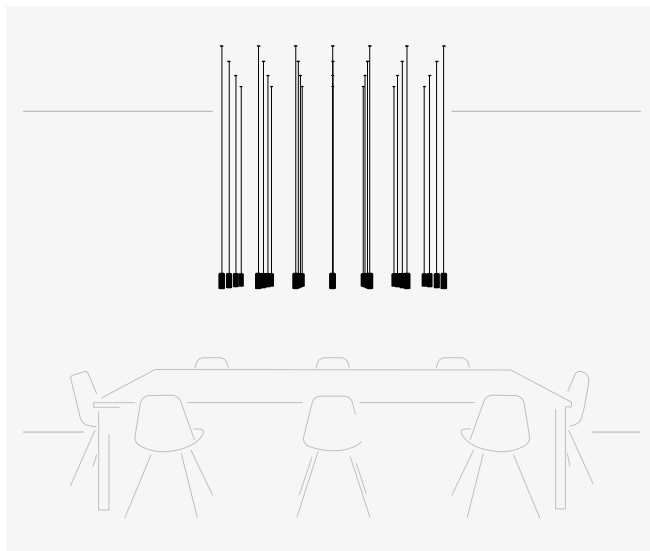

28 x 0361.



28 x 0345.

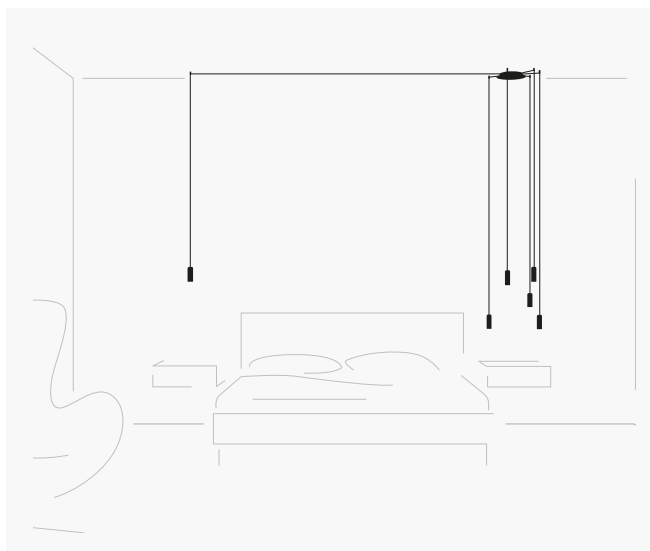

6 x 0345.

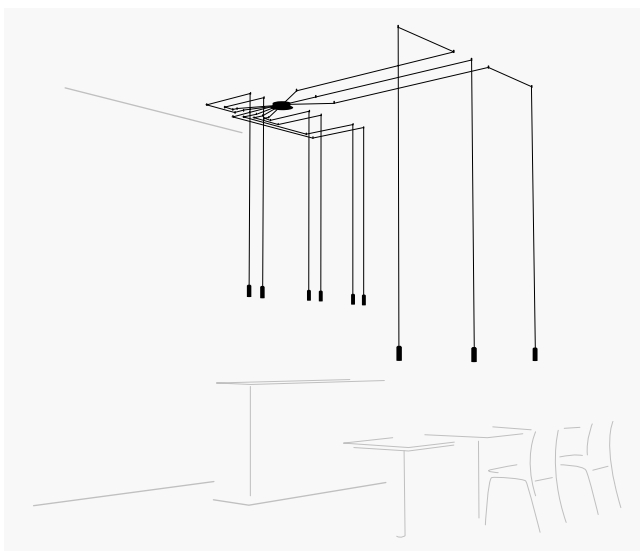

9 x 0361.

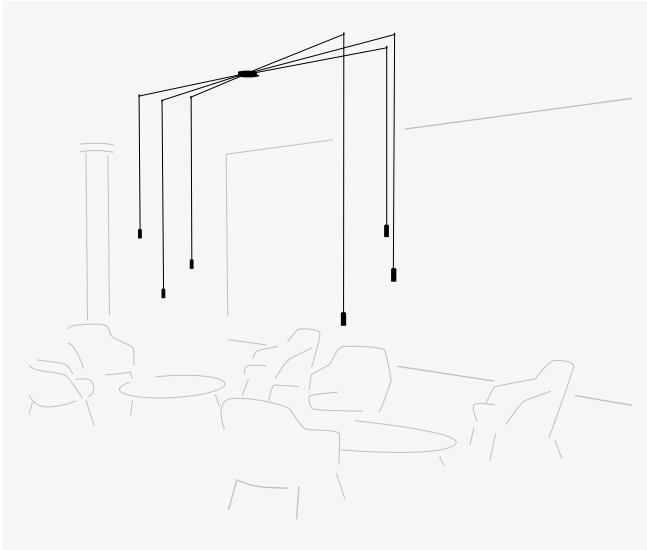

6 x 0361.

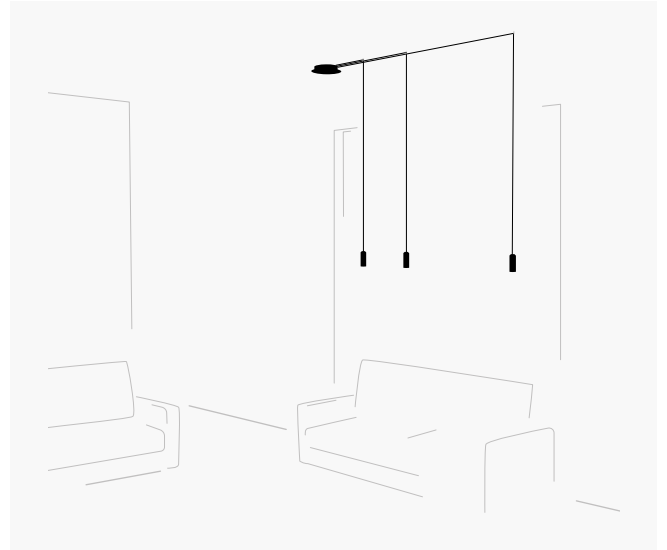

3 x 0361.

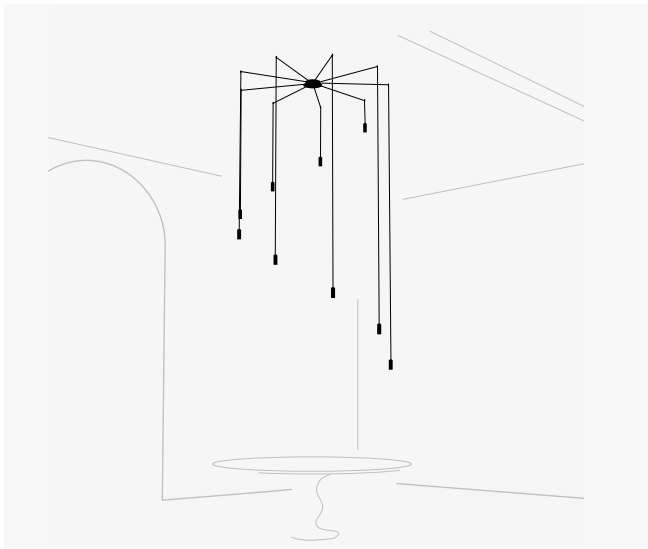

9 x 0345.

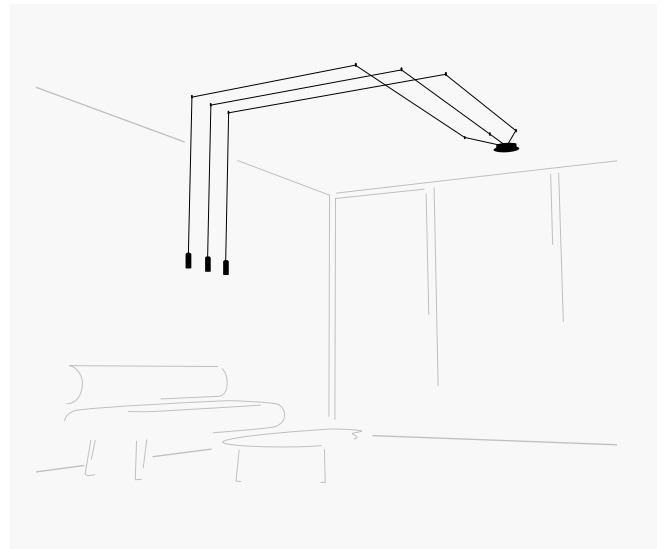

3 x 0361.

# Composing pendants

Next sketches are composed by one or more compositions

---

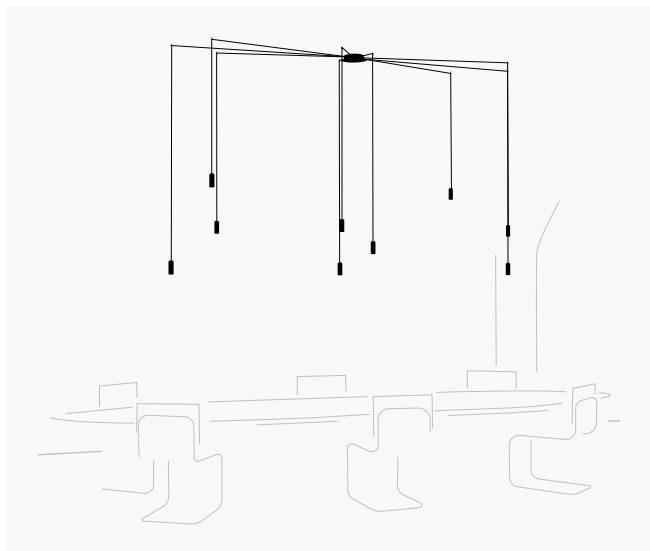

9 x 0361.

Each project is unique.  
Visit [vibia.com](http://vibia.com) and  
chose among multiple  
compositions designed  
and adapted to your  
project needs.

Personalise your own  
Wireflow FreeForm  
composition quick  
and easy at [vibia.com](http://vibia.com)

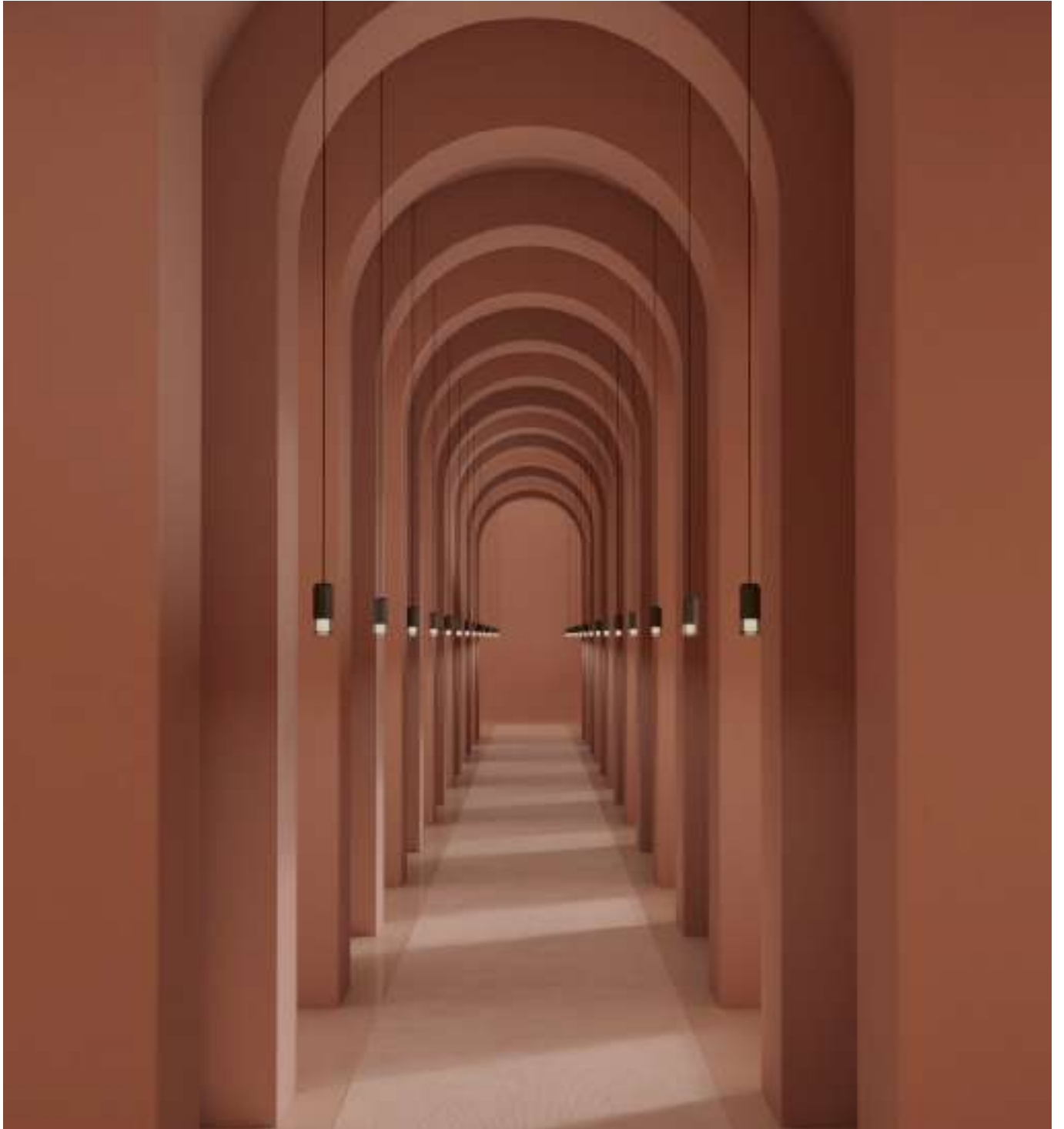

# Electrical connection options for models 0345 / 0361

Choose your preferred installation option according to your needs. For each composition, the optimal minimum number of drivers will be delivered.

## Drop ceiling

The innovative remote and built-in fittings accentuate the silkiness and lightness of compositions on suspended ceilings, its great visual grandeur taking center stage.

For Ref. 0345 / 0361

### Remote

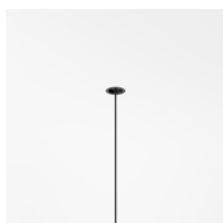

**Micro**  $\varnothing$  3 cm  
height 7 cm  
for plaster ceilings.  
Black finish.

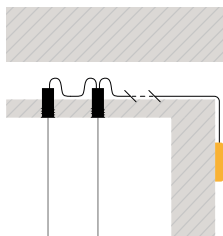

### Built-in



$\varnothing$  8 cm  
height 6 cm  
match with  
fixture finish.

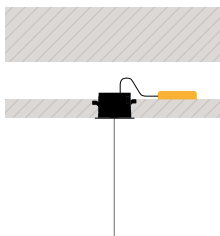



## Regular ceiling

When architecture does not allow for performance, surface and free wire showcase possibilities for any need or desire with no limits, ideal for both individual or cluster arrangements.

For Ref. 0345 / 0361

### Surface



ø 20 cm  
match with  
fixture finish.

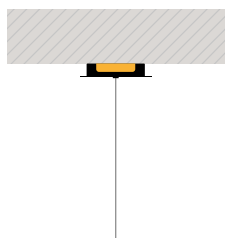

### Free Wire

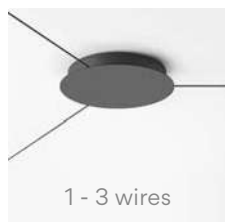

1 - 3 wires

ø 20 cm



4 - 6 wires

ø 36 cm



7 - 9 wires

ø 40 cm

you can choose the finish of the canopy  
among black, white or any colour  
matching one of the pendants.

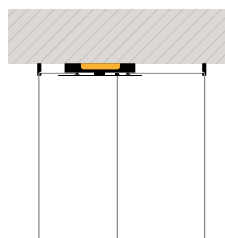

# Wireflow Chandelier

Design by Arik Levy

Wireflow is a collection of pendant lights that are at once presence and absence. Featuring slender black, electrical cables tipped with LED light terminals, its three-dimensional forms represent a contemporary reinterpretation of the traditional chandelier.

## Pendants

0315

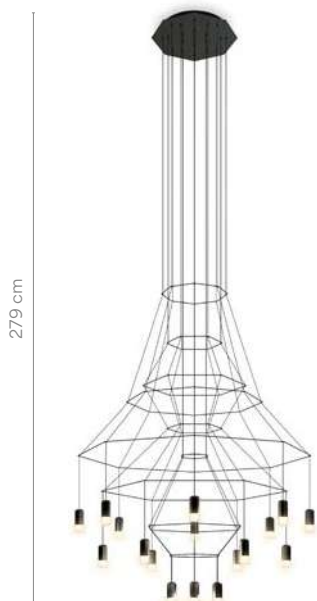

0374

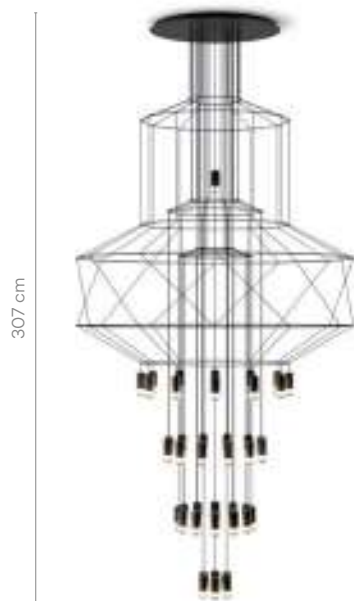

0375



0376



0377



0378



Each project is unique. Visit [vibia.com](http://vibia.com) and chose among multiple compositions designed and adapted to your project needs.

Personalise your own Wireflow composition quick and easy at [vibia.com](http://vibia.com)

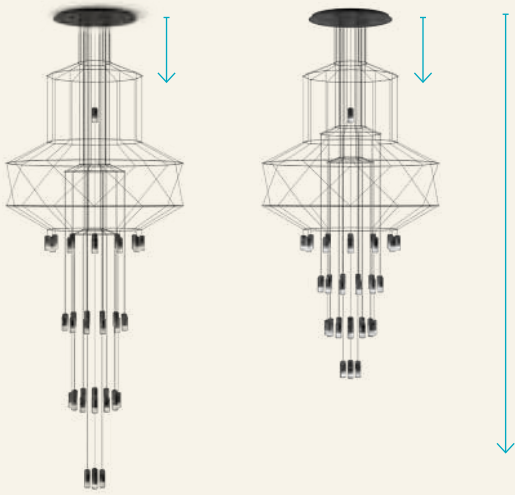
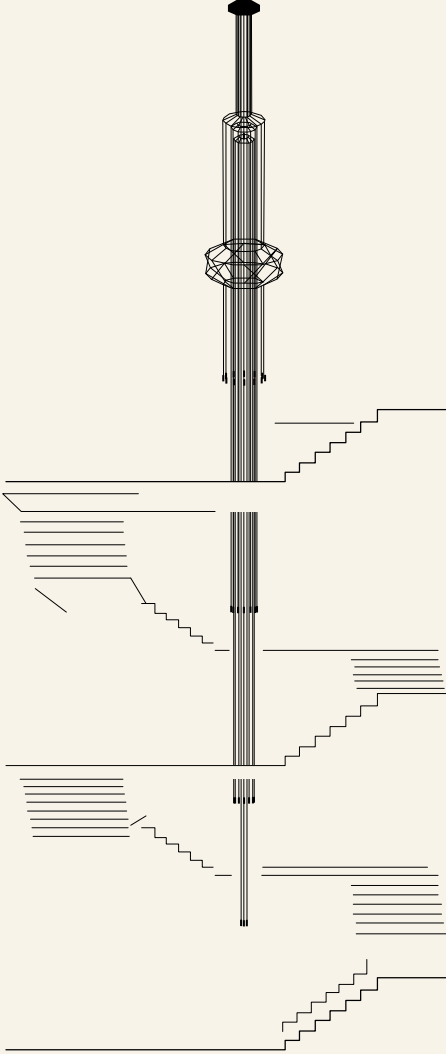

For configurations longer than 9 m, please ask Vibia customer service.



# Wireflow Chandelier

0315

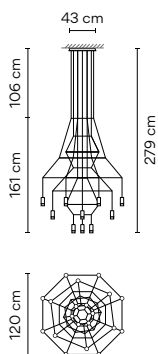

|  |  |  |
|--|--|--|
| <b>Finishes</b><br>● <b>04/</b> __ Black<br>(RAL 9005) | <b>LED temperature colour</b><br>/1 _ 2700 K<br>CRI >90 9700 lm 121 lm/W | <b>Control</b><br><b>0315</b> __ / _ A <span style="float: right;"><b>5.050,00 €</b></span><br>DALI-2, 1-10V, Push |
|  | /2 _ 3000 K<br>CRI >90 9700 lm 121 lm/W                                  | <b>0315</b> __ / _ Z <span style="float: right;"><b>5.170,00 €</b></span><br>Casambi                               |
|  | /3 _ 3500 K<br>CRI >90 10006,1 lm 125,1 lm/W                             |  |

**Materials**  
 Diffuser: Pressed-glass. Body: Aluminum.  
 Canopy and horizontal rods: Steel.

**Light Source and electronics**  
 20 x LED 4,5 W 700 mA  
 Constant Current 700 mA  
 100~240V 50/60Hz

**Packaging**  
 2 Boxes  
 Total Vol 0,3832 m<sup>3</sup>  
 Gross weight 32 Kg Net weight 18 Kg

**Notes**  
 Configuration layout at [vibia.com](http://vibia.com)

0374

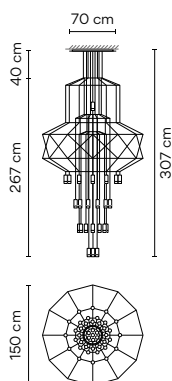

|  |   |   |
|--|---|---|
| <b>Finishes</b><br>● <b>04/</b> __ Black<br>(RAL 9005) | <b>LED temperature colour</b><br>/1 _ 2700 K<br>CRI >90 20855 lm 121 lm/W | <b>Control</b><br><b>0374</b> __ / _ A <span style="float: right;"><b>11.100,00 €</b></span><br>DALI-2, 1-10V, Push |
|  | /2 _ 3000 K<br>CRI >90 20855 lm 121 lm/W                                  | <b>0374</b> __ / _ Z <span style="float: right;"><b>11.220,00 €</b></span><br>Casambi                               |
|  | /3 _ 3500 K<br>CRI >90 21513,1 lm 125,1 lm/W                              |   |

**Materials**  
 Diffuser: Pressed-glass. Body: Aluminum.  
 Canopy and horizontal rods: Steel.

**Light Source and electronics**  
 43 x LED 4,5 W 700 mA  
 Constant Current 700 mA  
 100~240V 50/60Hz

**Packaging**  
 2 Boxes  
 Total Vol 0,5000 m<sup>3</sup>  
 Gross weight 57 Kg Net weight 47 Kg

**Notes**  
 Configuration layout at [vibia.com](http://vibia.com)

0375

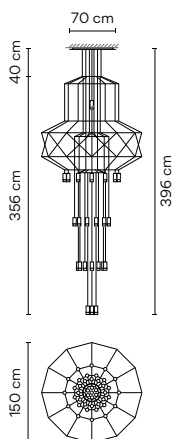

|  |   |   |
|--|---|---|
| <b>Finishes</b><br>● <b>04/</b> __ Black<br>(RAL 9005) | <b>LED temperature colour</b><br>/1 _ 2700 K<br>CRI >90 20855 lm 121 lm/W | <b>Control</b><br><b>0375</b> __ / _ A <span style="float: right;"><b>11.370,00 €</b></span><br>DALI-2, 1-10V, Push |
|  | /2 _ 3000 K<br>CRI >90 20855 lm 121 lm/W                                  | <b>0375</b> __ / _ Z <span style="float: right;"><b>11.490,00 €</b></span><br>Casambi                               |
|  | /3 _ 3500 K<br>CRI >90 21513,1 lm 125,1 lm/W                              |   |

**Materials**  
 Diffuser: Pressed-glass. Body: Aluminum.  
 Canopy and horizontal rods: Steel.

**Light Source and electronics**  
 43 x LED 4,5 W 700 mA  
 Constant Current 700 mA  
 100~240V 50/60Hz

**Packaging**  
 2 Boxes  
 Total Vol 0,5000 m<sup>3</sup>  
 Gross weight 57 Kg Net weight 47 Kg

**Notes**  
 Configuration layout at [vibia.com](http://vibia.com)

0376

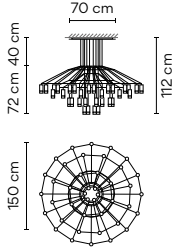

| Finishes                   | LED temperature colour                     | Control                            |             |
|----------------------------|--|------------------------------------|-------------|
| ● 04/ _ _ Black (RAL 9005) | /1 _ 2700 K  CRI >90 20370 lm 121 lm/W     | 0376 _ _ / _ A DALI-2, 1-10V, Push | 10.155,00 € |
|                            | /2 _ 3000 K  CRI >90 20370 lm 121 lm/W     | 0376 _ _ / _ Z Casambi             | 10.275,00 € |
|                            | /3 _ 3500 K  CRI >90 21012,8 lm 125,1 lm/W |                                    |             |

**Materials**  
 Diffuser: Pressed-glass. Body: Aluminum. Canopy and horizontal rods: Steel.

**Light Source and electronics**  
 42 x LED 4,5 W 700 mA  
 Constant Current 700 mA  
 100~240V 50/60Hz

**Packaging**  
 2 Boxes  
 Total Vol 0,5000 m³  
 Gross weight 56 Kg Net weight 46 Kg

**Notes**  
 Configuration layout at [vibia.com](http://vibia.com)

LED IP20

0377

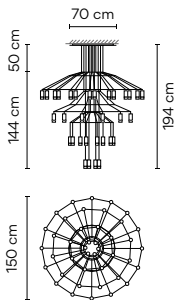

| Finishes                   | LED temperature colour                     | Control                            |             |
|----------------------------|--|------------------------------------|-------------|
| ● 04/ _ _ Black (RAL 9005) | /1 _ 2700 K  CRI >90 20370 lm 121 lm/W     | 0377 _ _ / _ A DALI-2, 1-10V, Push | 10.420,00 € |
|                            | /2 _ 3000 K  CRI >90 20370 lm 121 lm/W     | 0377 _ _ / _ Z Casambi             | 10.540,00 € |
|                            | /3 _ 3500 K  CRI >90 21012,8 lm 125,1 lm/W |                                    |             |

**Materials**  
 Diffuser: Pressed-glass. Body: Aluminum. Canopy and horizontal rods: Steel.

**Light Source and electronics**  
 42 x LED 4,5 W 700 mA  
 Constant Current 700 mA  
 100~240V 50/60Hz

**Packaging**  
 2 Boxes  
 Total Vol 0,5000 m³  
 Gross weight 56 Kg Net weight 46 Kg

**Notes**  
 Configuration layout at [vibia.com](http://vibia.com)

LED IP20

0378

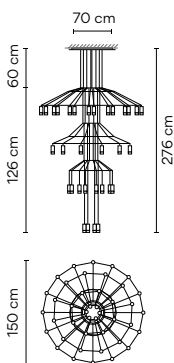

| Finishes                   | LED temperature colour                     | Control                            |             |
|----------------------------|--|------------------------------------|-------------|
| ● 04/ _ _ Black (RAL 9005) | /1 _ 2700 K  CRI >90 20370 lm 121 lm/W     | 0378 _ _ / _ A DALI-2, 1-10V, Push | 10.510,00 € |
|                            | /2 _ 3000 K  CRI >90 20370 lm 121 lm/W     | 0378 _ _ / _ Z Casambi             | 10.630,00 € |
|                            | /3 _ 3500 K  CRI >90 21012,8 lm 125,1 lm/W |                                    |             |

**Materials**  
 Diffuser: Pressed-glass. Body: Aluminum. Canopy and horizontal rods: Steel.

**Light Source and electronics**  
 42 x LED 4,5 W 700 mA  
 Constant Current 700 mA  
 100~240V 50/60Hz

**Packaging**  
 2 Boxes  
 Total Vol 0,5000 m³  
 Gross weight 56 Kg Net weight 46 Kg

**Notes**  
 Configuration layout at [vibia.com](http://vibia.com)

LED IP20

# Big

Design by Lievore, Altherr, Molina

Big breaks new ground in terms of scale and technology, revolutionising the ceiling light fitting.

## Ceiling

0530 0532

ø 120 cm



0531 0533

ø 100 cm



0530

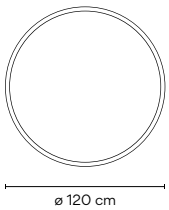
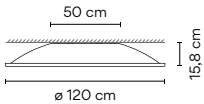

Finishes

- 01 Chrome (Metallic finish)
- 93 White (RAL 9016)

Materials

Shade: Aluminum. Diffuser: Methacrylate.  
Ring: Steel.

Light Source and electronics

2 x 2G11 230V 36 W  
2 x 2G11 230V 24 W

0530 \_ \_

2.040,00 €

Packaging

1 Box 0,38 x 1,37 x 1,37 m  
Vol 0,7080 m<sup>3</sup>  
Gross weight 21 Kg Net weight 18,9 Kg

Notes

Easy-to-install and replace bulb system.

**UNTIL STOCK RUNS OUT**



0531

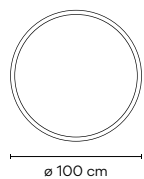
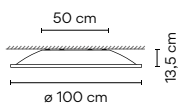

Finishes

- 01 Chrome (Metallic finish)
- 93 White (RAL 9016)

Materials

Shade: Aluminum. Diffuser: Methacrylate.  
Ring: Steel.

Light Source and electronics

2 x 2G11 230V 36 W  
2 x 2G11 230V 24 W

0531 \_ \_

1.460,00 €

Packaging

1 Box 0,34 x 1,14 x 1,14 m  
Vol 0,4420 m<sup>3</sup>  
Gross weight 15,2 Kg Net weight 13,68 Kg

Notes

Easy-to-install and replace bulb system.

**UNTIL STOCK RUNS OUT**



0532

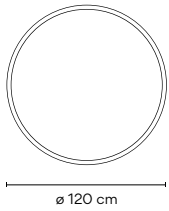
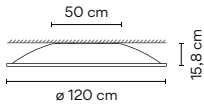

Finishes  
 01/ \_\_ Chrome  
 (Metallic finish)  
 93/ \_\_ White  
 (RAL 9016)

LED temperature colour  
 /2 3000 K   
 CRI >90 8944 lm 132 lm/W

| Control                      | Price      |
|------------------------------|------------|
| 0532 __ / _ 1<br>DALI-2      | 2.335,00 € |
| 0532 __ / _ B<br>1-10V, Push | 2.220,00 € |
| 0532 __ / _ Z<br>Casambi     | 2.340,00 € |

Materials

Shade: Aluminum. Diffuser: Methacrylate.  
 Ring: Steel.

Light Source and electronics  
 4 x LED Quadrant 18,9 W 500 mA  
 Constant Current 500 mA  
 220-240V 50/60Hz

Packaging

1 Box 0,38 x 1,36 x 1,36 m  
 Vol 0,7080 m<sup>3</sup>  
 Gross weight 21 Kg Net weight 18,9 Kg

Notes

UNTIL STOCK RUNS OUT

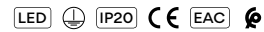

0533

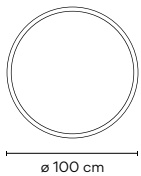
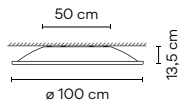

Finishes  
 01/ \_\_ Chrome  
 (Metallic finish)  
 93/ \_\_ White  
 (RAL 9016)

LED temperature colour  
 /2 3000 K   
 CRI >90 8944 lm 132 lm/W

| Control                      | Price      |
|------------------------------|------------|
| 0533 __ / _ 1<br>DALI-2      | 2.085,00 € |
| 0533 __ / _ B<br>1-10V, Push | 1.985,00 € |
| 0533 __ / _ Z<br>Casambi     | 2.105,00 € |

Materials

Shade: Aluminum. Diffuser: Methacrylate.  
 Ring: Steel.

Light Source and electronics  
 4 x LED Quadrant 18,9 W 500 mA  
 Constant Current 500 mA  
 220-240V 50/60Hz

Packaging

1 Box 0,34 x 1,14 x 1,14 m  
 Vol 0,4420 m<sup>3</sup>  
 Gross weight 15,2 Kg Net weight 13,68 Kg

Notes

UNTIL STOCK RUNS OUT

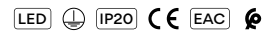

Easy-to-install and  
 replace bulb system.



Pendants



ø 120 cm

0530 0532



ø 100 cm

0536 0538

0535

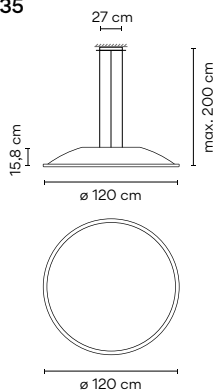

Finishes

- 01 Chrome (Metallic finish)
- 93 White (RAL 9016)

0535 \_\_ 2.110,00 €

Materials

Shade: Aluminum. Diffuser: Methacrylate.  
Ring: Steel. Canopy: Steel.

Light Source and electronics

2 x 2G11 230V 36 W  
2 x 2G11 230V 24 W

Packaging

1 Box 0,38 x 1,37 x 1,37 m  
Vol 0,7080 m<sup>3</sup>  
Gross weight 25,6 Kg Net weight 23,04 Kg

Notes

Easy-to-install and replace bulb system  
Extra cable length. 16,00 €/m

UNTIL STOCK RUNS OUT



0536

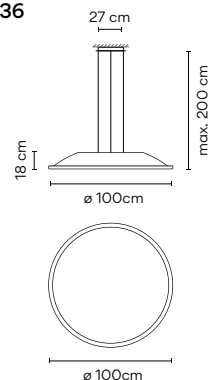

Finishes

- 01 Chrome (Metallic finish)
- 93 White (RAL 9016)

0536 \_\_ 1.770,00 €

Materials

Shade: Aluminum. Diffuser: Methacrylate.  
Ring: Steel. Canopy: Steel.

Light Source and electronics

2 x 2G11 230V 36 W  
2 x 2G11 230V 24 W

Packaging

1 Box 0,34 x 1,14 x 1,14 m  
Vol 0,4420 m<sup>3</sup>  
Gross weight 19,6 Kg Net weight 17,64 Kg

Notes

Easy-to-install and replace bulb system  
Extra cable length. 16,00 €/m

UNTIL STOCK RUNS OUT





1160 10 /1A

Model Finish  
LED temperature colour Control



0537

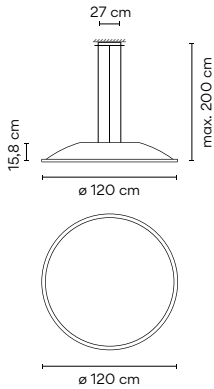

Finishes  
 01/ \_\_ Chrome  
 (Metallic finish)  
 93/ \_\_ White  
 (RAL 9016)

LED temperature colour  
 /2 3000 K   
 CRI >90 8944 lm 132 lm/W

Control  
 0537 \_\_ / \_ 1 2.565,00 €  
 DALI-2  
 0537 \_\_ / \_ B 2.440,00 €  
 1-10V, Push  
 0537 \_\_ / \_ Z 2.560,00 €  
 Casambi

Materials  
 Shade: Aluminum. Diffuser: Methacrylate.  
 Ring: Steel. Canopy: Steel.  
 Light Source and electronics  
 4 x LED Quadrant 18,9 W 500 mA  
 Constant Current 500 mA  
 220-240V 50/60Hz

Packaging  
 1 Box 0,38 x 1,36 x 1,36 m  
 Vol 0,7080 m<sup>3</sup>  
 Gross weight 25,6 Kg Net weight 23,04 Kg

Notes  
 Extra cable length. 16,00 €/m  
 UNTIL STOCK RUNS OUT

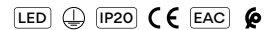

0538

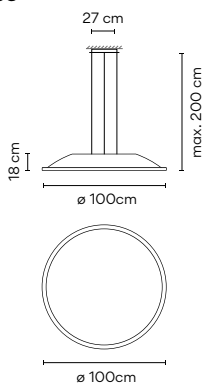

Finishes  
 01/ \_\_ Chrome  
 (Metallic finish)  
 93/ \_\_ White  
 (RAL 9016)

LED temperature colour  
 /2 3000 K   
 CRI >90 8944 lm 132 lm/W

Control  
 0538 \_\_ / \_ 1 2.230,00 €  
 DALI-2  
 0538 \_\_ / \_ B 2.120,00 €  
 1-10V, Push  
 0538 \_\_ / \_ Z 2.240,00 €  
 Casambi

Materials  
 Shade: Aluminum. Diffuser: Methacrylate.  
 Ring: Steel. Canopy: Steel.  
 Light Source and electronics  
 4 x LED Quadrant 18,9 W 500mA   
 Constant Current 500 mA  
 220-240V 50/60Hz

Packaging  
 1 Box 0,38 x 1,36 x 1,36 m  
 Vol 0,7080 m<sup>3</sup>  
 Gross weight 19,6 Kg Net weight 17,64 Kg

Notes  
 Extra cable length. 16,00 €/m  
 UNTIL STOCK RUNS OUT

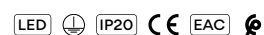

# Big Built-in

Design by Lievore, Altherr, Molina

Big reimagines the utilitarian ceiling light with an enlarged diffuser that covers nearly the entire chrome fitting. The simple, oversized shape evokes a glowing orb overhead, its pure, geometric silhouette mimicking the effect of a skylight.

## Ceiling

0540

ø 123 cm



0546 0547

ø 36 cm



0543 0544

ø 60 cm



Chrome ring.  
Easy-to-install and replace  
bulb system.



0540

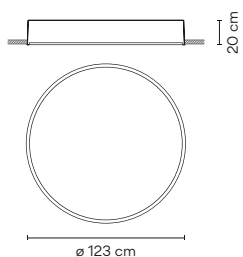

Finishes

- 01 Chrome (Metallic finish)
- 93 White (RAL 9016)

Materials

Diffuser: Methacrylate. Built-in body: Aluminum.  
Ring: Steel.

Light Source and electronics

- 2 x G5 230V 24 W (T5)
- 2 x G5 230V 39 W (T5)
- 2 x G5 230V 54 W (T5)

0540 \_ \_

2.015,00 €

Packaging

1 Box 0,38 x 1,37 x 1,37 m  
Vol 0,7080 m<sup>3</sup>  
Gross weight 23 Kg Net weight 1 Kg

Notes

Built-in

**UNTIL STOCK RUNS OUT**

IP20 CE EAC ø 121 cm

0543

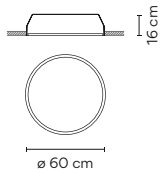

- Finishes
- 01 Chrome (Metallic finish)
  - 93 White (RAL 9016)

0543 \_\_ 905,00 €

Materials  
Diffuser: Methacrylate. Built-in body: Aluminum.  
Ring: Steel.

Light Source and electronics  
2 x 2G11 230V 24 W  
2 x 2G11 230V 36 W

Packaging  
1 Box 0,27 x 0,76 x 0,76 m  
Vol 0,1550 m<sup>3</sup>  
Gross weight 7 Kg Net weight 4,50 Kg

Notes  
Built-in  
UNTIL STOCK RUNS OUT

⊕ IP20 CE EAC ⚡ ⌀ 58,7 cm

0544

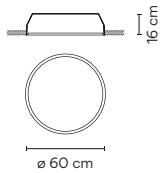

- Finishes
- 01 Chrome (Metallic finish)
  - 93 White (RAL 9016)

0544 \_\_ 720,00 €

Materials  
Diffuser: Methacrylate. Built-in body: Aluminum.  
Ring: Steel.

Light Source and electronics  
2 x 2G11 230V 24 W  
2 x 2G11 230V 36 W

Packaging  
1 Box 0,27 x 0,76 x 0,76 m  
Vol 0,1550 m<sup>3</sup>  
Gross weight 8 Kg Net weight 5 Kg

Notes  
Built-in  
UNTIL STOCK RUNS OUT

⊕ IP20 CE EAC ⚡ ⌀ 58,7 cm

0546

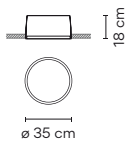

- Finishes
- 01 Chrome (Metallic finish)
  - 93 White (RAL 9016)

0546 \_\_ 465,00 €

Materials  
Diffuser: Methacrylate. Built-in body: Aluminum.  
Ring: Steel.

Light Source and electronics  
1 x 2GX13 230V 55W (T5C)

Packaging  
1 Box 0,25 x 0,42 x 0,42 m  
Vol 0,0440 m<sup>3</sup>  
Gross weight 2,5 Kg Net weight 2 Kg

Notes  
Built-in  
UNTIL STOCK RUNS OUT

⊕ IP20 CE EAC ⚡ ⌀ 34 cm

0547

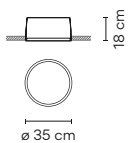

- Finishes
- 01 Chrome (Metallic finish)
  - 93 White (RAL 9016)

0547 \_\_ 395,00 €

Materials  
Diffuser: Methacrylate. Built-in body: Aluminum.  
Ring: Steel.

Light Source and electronics  
1 x 2GX13 230V 55 W (T5C)

Packaging  
1 Box 0,25 x 0,42 x 0,42 m  
Vol 0,0440 m<sup>3</sup>  
Gross weight 2,5 Kg Net weight 2 Kg

Notes  
Built-in  
UNTIL STOCK RUNS OUT

⊕ IP20 CE EAC ⚡ ⌀ 34 cm

# I.Cono

Design by Lievore, Altherr, Molina

Exuding a poised, Scandinavian presence, I.Cono is distinguished by its signature visor-shaped shade that's sleekly angled for a stylish look. Ideal for precision lighting or reading, its pure and clean design conceals its rotation mechanisms.

Table Floor Wall



0712



0700



0720

## 0700

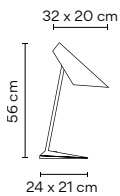

### Finishes

- **10 White**  
(NCS S 0300-N)
- **21 Black Grey**  
(NCS S 7000-N)
- **25 Beige D1**  
(NCS S 4005-G80Y)
- **37 Terra Red**  
(NCS S 4040-Y70R)
- **42 Blue M1**  
(NCS S 5010-B10G)

### Materials

Shade: Polycarbonate. Base: Zamak.  
Vertical tube: Steel.

### Light Source and electronics

1 x LED E14 230V 7 W

### LED temperature colour

2700 K 800 lm/W

0700 \_\_

505,00 €

### Packaging

1 Box 0,81 x 0,31 x 0,33 m  
Vol 0,0828 m<sup>3</sup>  
Gross weight 5,2 Kg Net weight 3,2 Kg

### Notes

Switch on the base.  
Electric cable 2 m



0712

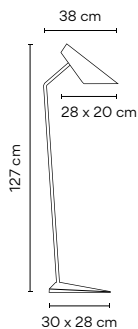

- Finishes
- 10 White (NCS S 0300-N)
  - 21 Black Grey (NCS S 7000-N)
  - 25 Beige D1 (NCS S 4005-G80Y)
  - 37 Terra Red (NCS S 4040-Y70R)
  - 42 Blue M1 (NCS S 5010-B10G)
- LED temperature colour  
2700 K 800 lm/W

0712 \_\_ 710,00 €

Materials  
Shade: Polycarbonate. Base: Zamak.  
Vertical tube: Steel.

Light Source and electronics  
1 x LED E14 230V 7 W

Packaging  
1 Box 0,34 x 1,50 x 0,32 m  
Vol 0,1632 m<sup>3</sup>  
Gross weight 16 Kg Net weight 11,8 Kg

Notes  
Switch on the cable.  
Electric cable 1,5 m



0720

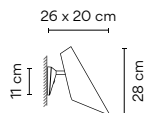

- Finishes
- 10 White (NCS S 0300-N)
  - 21 Black Grey (NCS S 7000-N)
  - 25 Beige D1 (NCS S 4005-G80Y)
  - 37 Terra Red (NCS S 4040-Y70R)
  - 42 Blue M1 (NCS S 5010-B10G)
- LED temperature colour  
2700 K 800 lm/W

0720 \_\_ 410,00 €

Materials  
Shade: Polycarbonate.  
Wall plate: Zamak.

Light Source and electronics  
1 x LED E14 230V 7 W

Packaging  
1 Box 0,21 x 0,48 x 0,21 m  
Vol 0,0212 m<sup>3</sup>  
Gross weight 2,2 Kg Net weight 1 Kg

Notes  
On/off switch on the wall plate



# Algorithm Free

Design by Toan Nguyen

Like a cloud of frozen rain, this collection brings together beauty and geometry. Mathematical order provides a magical harmony with an astonishing range of permutations and compositions. Can be customized to suit any space.

## Pendants

\* Built-in version

0820 \*0822



0820

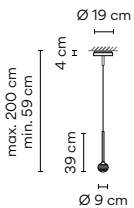

| Finishes                                | LED temperature colour |
|---|------------------------|
| ● 18/ _ _ Graphite<br>(ADAPTA RF9913WX) | /1_ 2700 K             |
| ● 93/ _ _ White<br>(RAL 9016)           | /3_ 3500 K             |

**Materials**  
Ball: Blowed glass. Glass fixation: Aluminum.  
Ceiling rose: Steel. Diffuser: PC. Pendant structure: Steel.

**Light Source and electronics**  
1 x LED 3,15 W 1050 mA  
Constant Current 1050 mA  
100~240V 50/60Hz

| Control                             |          |
|-------------------------------------|----------|
| 0820 _ / _ A<br>DALI-2, 1-10V, Push | 475,00 € |
| 0820 _ / _ Z<br>Casambi             | 595,00 € |

**Packaging**  
1 Box 0,18 x 0,55 x 0,55 m  
Vol 0,0131 m<sup>3</sup>  
Gross weight 2,17 Kg Net weight 1,57 Kg

**Notes**  
Surface.  
Extra cable length. 16,00 €/m

**Electrical connection**  
Surface  
\_18 Free Wire  
\_23 Built-in  
\_31 Remote  
Micro  
for plaster  
ceilings  
\_32 Remote  
XXS  
for all types  
of drop  
ceilings

1160 10 /1A \_18  
 Model Finish LED temperature colour Control Electrical connection Only for pendants



0822

|   |  |  |
|---|--|--|
| <b>Finishes</b><br>● 18/ _ _ Graphite (ADAPTA RF9913WX)<br>● 93/ _ _ White (RAL 9016) | <b>LED temperature colour</b><br>/1_ 2700 K<br>CRI >90 312,28 lm 90 lm/W<br>/3_ 3500 K<br>CRI >90 312,3 lm 99,1 lm/W | <b>Control</b><br>0822 _ _ / A 475,00 €<br>DALI-2, 1-10V, Push |
|   |  | 0822 _ _ / Z 595,00 €<br>Casambi                               |

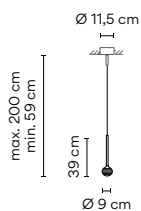

**Materials**  
 Ball: Blowed glass. Glass fixation: Aluminum.  
 Ceiling rose: Steel. Diffuser: PC. Pendant structure: Steel.

**Light Source and electronics**  
 1 x LED 3,15 W 1050 mA  
 Constant Current 1050 mA  
 100~240V 50/60Hz

**Packaging**  
 1 Box 0,18 x 0,55 x 0,55 m  
 Vol 0,0131 m³  
 Gross weight 2,17 Kg Net weight 1,57 Kg

**Notes**  
 Built-in.  
 Extra cable length. 16,00 €/m  
**UNTIL STOCK RUNS OUT**

ø 10,5 cm

# Composing pendants

Next sketches are composed by one or more compositions

---

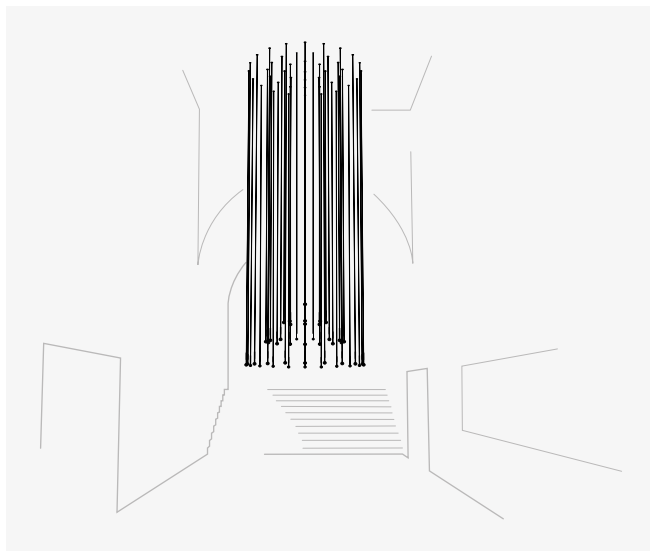

52 x 0820.

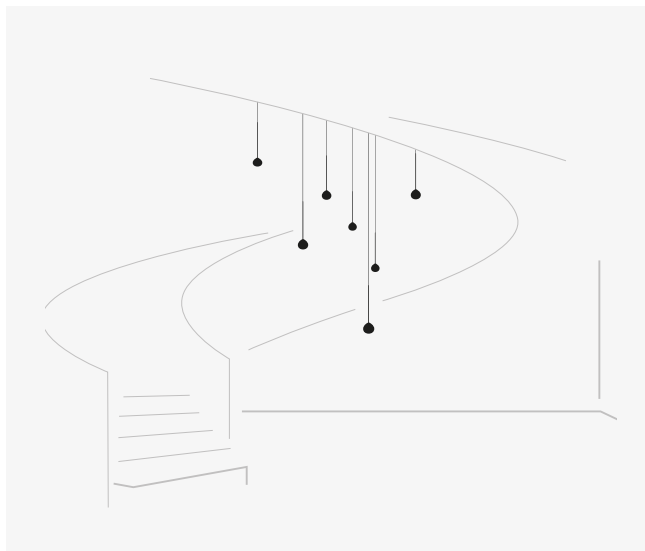

7 x 0820.

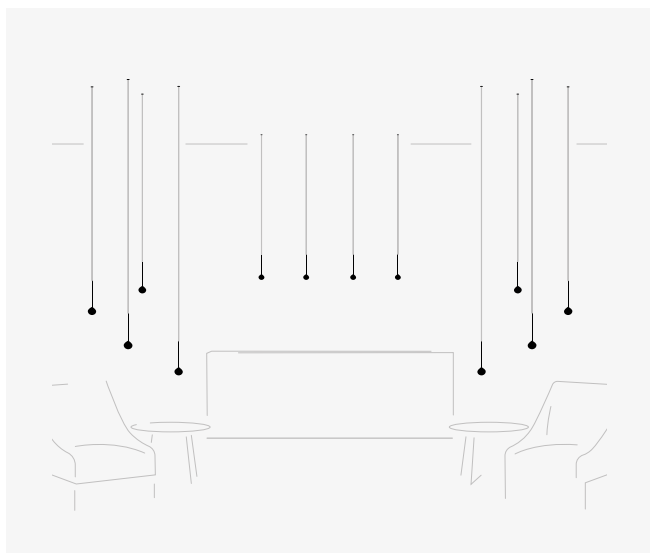

12 x 0820.

Each project is unique.  
Visit [vibia.com](http://vibia.com) and  
chose among multiple  
compositions designed  
and adapted to your  
project needs.

Personalise your own  
Algorithm composition quick  
and easy at [vibia.com](http://vibia.com)





# Electrical connection options for model 0820

## Drop ceiling

The innovative remote and built-in fittings accentuate the silkiness and lightness of compositions on suspended ceilings, its great visual grandeur taking center stage.

For Ref. 0820

### Remote

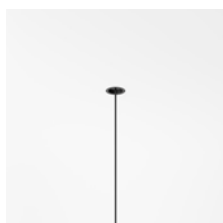

**Micro**  $\varnothing$  3 cm  
height 7 cm  
for plaster ceilings.  
Black finish.

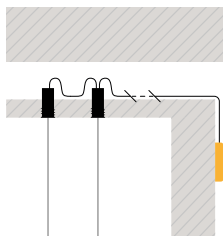

### Built-in



$\varnothing$  8 cm  
height 6 cm  
match with  
fixture finish.

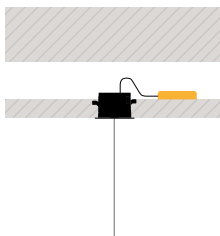

---

## Regular ceiling

When architecture does not allow for performance, surface and free wire showcase possibilities for any need or desire with no limits, ideal for both individual or cluster arrangements.

For Ref. 0820

### Surface



ø 19 cm

match with  
fixture finish.

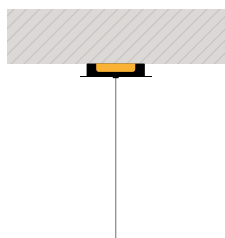

### Free Wire

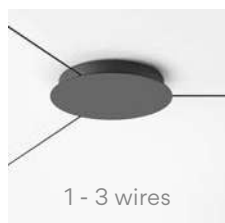

1 - 3 wires

ø 22 cm

you can choose the finish of the canopy  
among black, white or any colour  
matching one of the pendants.



4 - 6 wires

ø 36 cm



7 - 9 wires

ø 40 cm

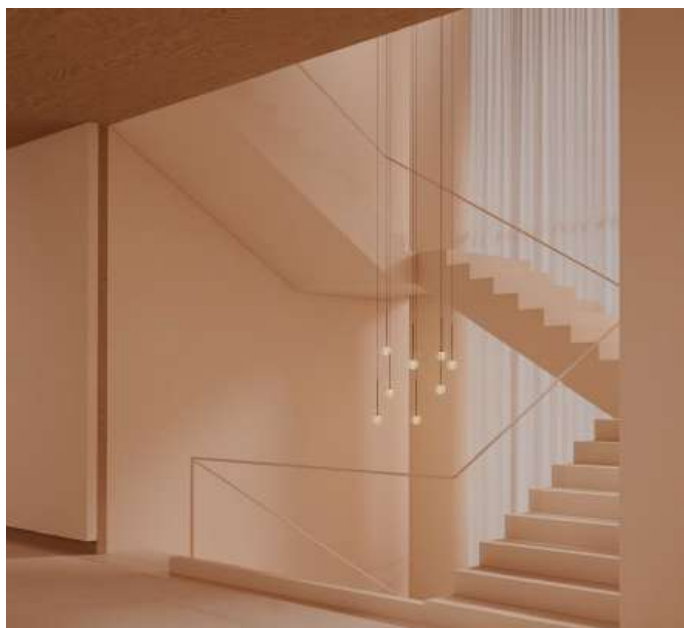
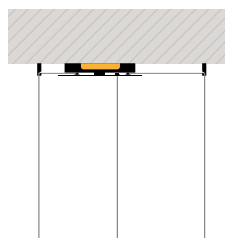

# Algorithm Grid

Design by Toan Nguyen

Like a cloud of frozen rain, this collection brings together beauty and geometry. Mathematical order provides a magical harmony with an astonishing range of permutations and compositions. Can be customized to suit any space.

## Pendants

\* Built-in version



75 cm

**0825 \*0827**



89 cm

**0880 \*0882**



160 cm

**0885 \*0887**

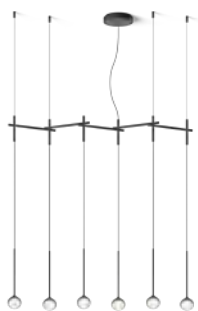

123 cm

**0830 \*0832**

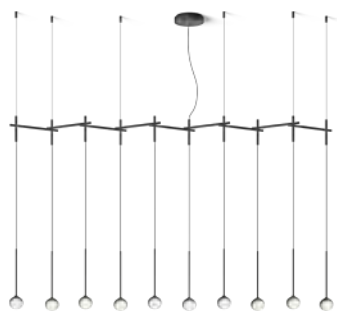

214 cm

**0835 \*0837**

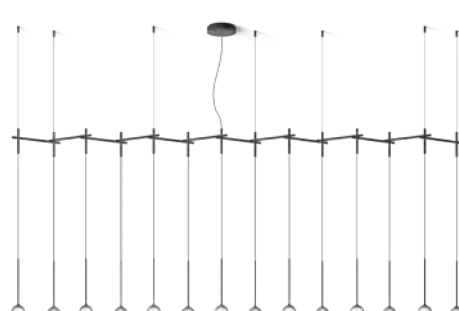

305 cm

**0840 \*0842**

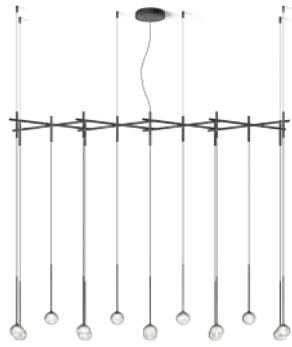

183 cm

**0845 \*0847**



399 cm

**0850 \*0852**



60 cm

**0855 \*0857**

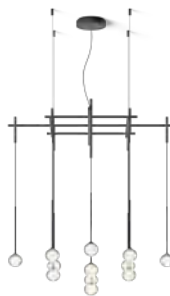

110 cm

**0860 \*0862**



160 cm

**0865 \*0867**

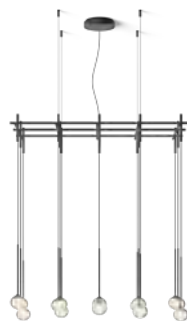

110 cm

**0870 \*0872**



185 cm

**0875 \*0877**

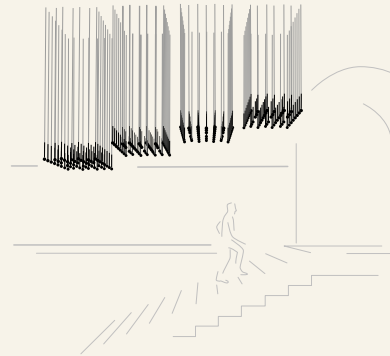
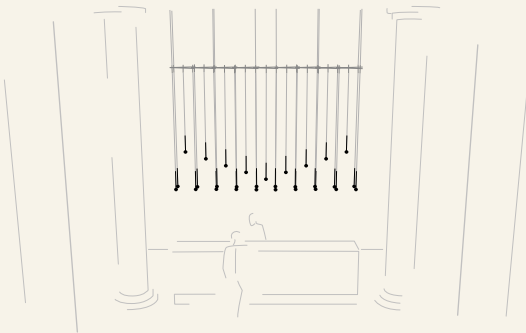
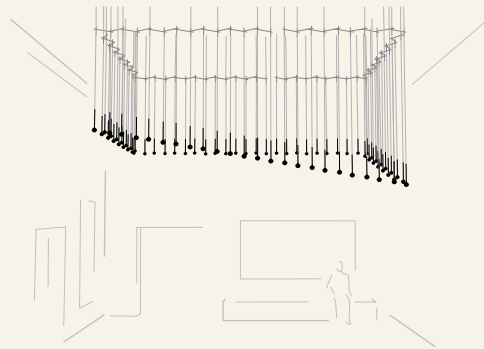
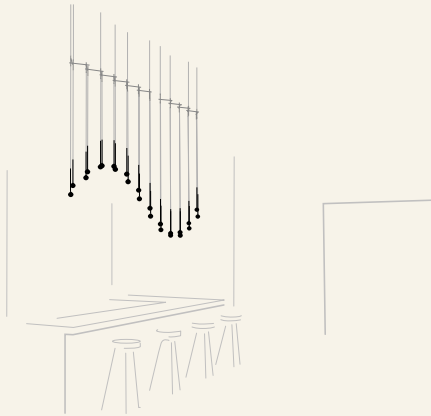
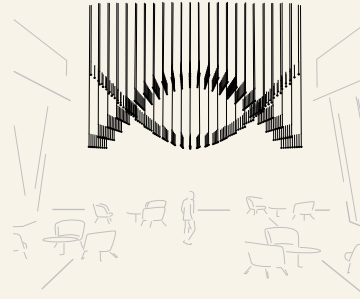
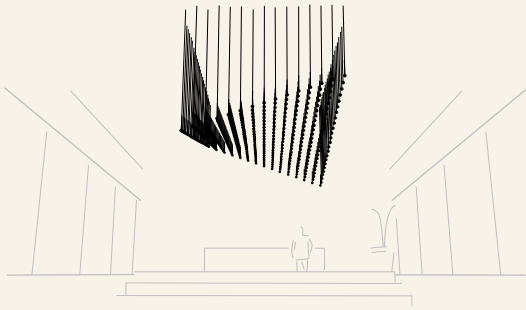

Surface.

Built-in.  
11,5 cm Die-cut diameter,  
12 cm minimum height in ceiling.

Adjustable cable installation.

Rigid stem installation.  
Fixed at 25 cm.

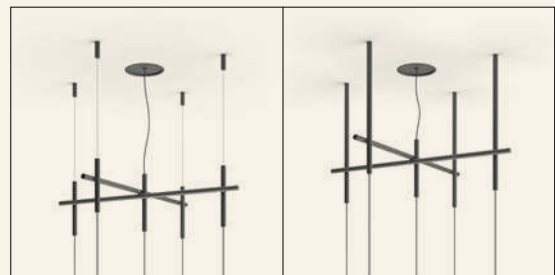
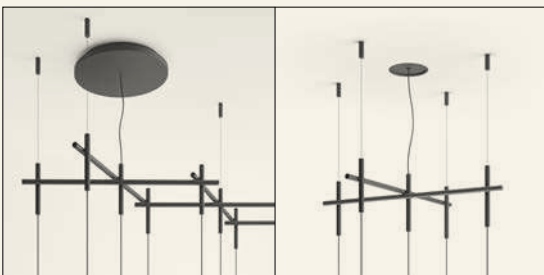

### Adjust height of standard model

To personalize luminaire height, without adjusting diffusers layout.

The steel cables that go from the structure to the ceiling are the only ones that allow the height of the lamp to be adjusted. The installation manual describes how to do this and how to cut the cables.

Personalise your own  
 Algorithm composition  
 quick and easy at  
[vibia.com](http://vibia.com)

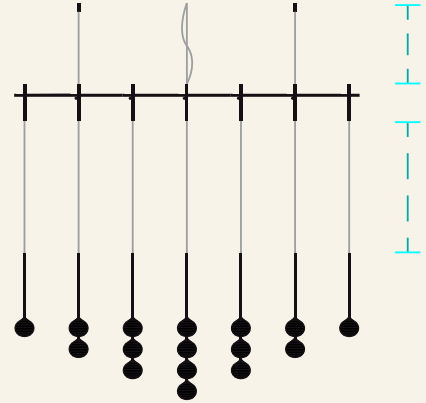

#### 0825

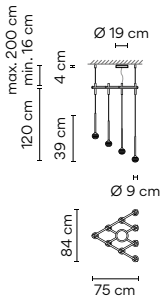

##### Finishes

- 18/ \_\_ Graphite (ADAPTA RF9913WX)
- 93/ \_\_ White (RAL 9016)

##### LED temperature colour

- /1 \_ 2700 K CRI >90 3122,8 lm 99 lm/W
- /3 \_ 3500 K CRI >90 3122,8 lm 99,1 lm/W

##### Control

- 0825 \_\_ / \_ A 2.785,00 €  
DALI-2, 1-10V, Push
- 0825 \_\_ / \_ Z 2.905,00 €  
Casambi

##### Materials

Ball: Blowed glass. Glass fixation: Aluminum.  
 Ceiling rose: Steel. Diffuser: PC. Pendant structure: Steel.

##### Light Source and electronics

10 x LED 3,15 W 1050 mA  
 Constant Current 1050 mA  
 100~240V 50/60Hz

##### Packaging

2 Boxes  
 Total Vol. 0,324 m<sup>3</sup>  
 Gross weight 15,5 Kg Net weight 10,5 Kg

##### Notes

Surface



#### 0827

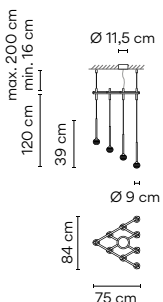

##### Finishes

- 18/ \_\_ Graphite (ADAPTA RF9913WX)
- 93/ \_\_ White (RAL 9016)

##### LED temperature colour

- /1 \_ 2700 K CRI >90 3122,8 lm 99 lm/W
- /3 \_ 3500 K CRI >90 3122,8 lm 99,1 lm/W

##### Control

- 0827 \_\_ / \_ A 2.785,00 €  
DALI-2, 1-10V, Push
- 0827 \_\_ / \_ Z 2.905,00 €  
Casambi

##### Materials

Ball: Blowed glass. Glass fixation: Aluminum.  
 Ceiling rose: Steel. Diffuser: PC. Pendant structure: Steel.

##### Light Source and electronics

10 x LED 3,15 W 1050 mA  
 Constant Current 1050 mA  
 100~240V 50/60Hz

##### Packaging

2 Boxes  
 Total Vol. 0,324 m<sup>3</sup>  
 Gross weight 15,5 Kg Net weight 10,5 Kg

##### Notes

Built-in

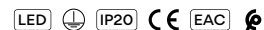

**0830**

|  |                               |                                       |
|--|-------------------------------|---------------------------------------|
| <b>Finishes</b>                                | <b>LED temperature colour</b> | <b>Control</b>                        |
| ● <b>18/</b> _ _ Graphite<br>(ADAPTA RF9913WX) | <b>/1</b> _ 2700 K            | <b>0830</b> _ / _ A <b>2.030,00 €</b> |
| ● <b>93/</b> _ _ White<br>(RAL 9016)           | CRI >90 1873,68 lm 99 lm/W    | DALI-2, 1-10V, Push                   |
|  | <b>/3</b> _ 3500 K            | <b>0830</b> _ / _ Z <b>2.150,00 €</b> |
|  | CRI >90 1873,7 lm 99,1 lm/W   | Casambi                               |

---

**Materials**  
Ball: Blowed glass. Glass fixation: Aluminum.  
Ceiling rose: Steel. Diffuser: PC. Pendant structure: Steel.

**Light Source and electronics**  
6 x LED 3,15 W 1050 mA  
Constant Current 1050 mA  
100~240V 50/60Hz

**Packaging**  
2 Boxes  
Total Vol. 0,1705 m<sup>3</sup>  
Gross weight 3,5 Kg Net weight 5,8 Kg

**Notes**  
Surface

**0832**

|  |                               |                                       |
|--|-------------------------------|---------------------------------------|
| <b>Finishes</b>                                | <b>LED temperature colour</b> | <b>Control</b>                        |
| ● <b>18/</b> _ _ Graphite<br>(ADAPTA RF9913WX) | <b>/1</b> _ 2700 K            | <b>0832</b> _ / _ A <b>2.030,00 €</b> |
| ● <b>93/</b> _ _ White<br>(RAL 9016)           | CRI >90 1873,68 lm 99 lm/W    | DALI-2, 1-10V, Push                   |
|  | <b>/3</b> _ 3500 K            | <b>0832</b> _ / _ Z <b>2.150,00 €</b> |
|  | CRI >90 1873,7 lm 99,1 lm/W   | Casambi                               |

---

**Materials**  
Ball: Blowed glass. Glass fixation: Aluminum.  
Ceiling rose: Steel. Diffuser: PC. Pendant structure: Steel.

**Light Source and electronics**  
6 x LED 3,15 W 1050 mA  
Constant Current 1050 mA  
100~240V 50/60Hz

**Packaging**  
2 Boxes  
Total Vol. 0,1705 m<sup>3</sup>  
Gross weight 3,5 Kg Net weight 5,8 Kg

**Notes**  
Built-in

**0835**

|  |                               |                                       |
|--|-------------------------------|---------------------------------------|
| <b>Finishes</b>                                | <b>LED temperature colour</b> | <b>Control</b>                        |
| ● <b>18/</b> _ _ Graphite<br>(ADAPTA RF9913WX) | <b>/1</b> _ 2700 K            | <b>0835</b> _ / _ A <b>2.990,00 €</b> |
| ● <b>93/</b> _ _ White<br>(RAL 9016)           | CRI >90 3122,8 lm 99 lm/W     | DALI-2, 1-10V, Push                   |
|  | <b>/3</b> _ 3500 K            | <b>0835</b> _ / _ Z <b>3.110,00 €</b> |
|  | CRI >90 3122,8 lm 99,1 lm/W   | Casambi                               |

---

**Materials**  
Ball: Blowed glass. Glass fixation: Aluminum.  
Ceiling rose: Steel. Diffuser: PC. Pendant structure: Steel.

**Light Source and electronics**  
10 x LED 3,15 W 1050 mA  
Constant Current 1050 mA  
100~240V 50/60Hz

**Packaging**  
2 Boxes  
Total Vol. 0,3220 m<sup>3</sup>  
Gross weight 15,5 Kg Net weight 10,5 Kg

**Notes**  
Surface



0837

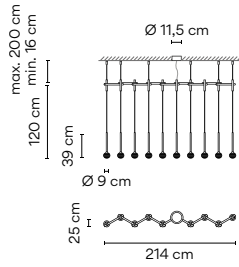

|  |                               |
|--|-------------------------------|
| <b>Finishes</b>                        | <b>LED temperature colour</b> |
| ● 18/ __ Graphite<br>(ADAPTA RF9913WX) | /1 _ 2700 K                   |
| ● 93/ __ White<br>(RAL 9016)           | /3 _ 3500 K                   |
|  | CRI >90 3122,8 lm 99 lm/W     |
|  | CRI >90 3122,8 lm 99,1 lm/W   |

|                |                      |                   |
|----------------|----------------------|-------------------|
| <b>Control</b> | <b>0837 __ / _ A</b> | <b>2.990,00 €</b> |
|                | DALI-2, 1-10V, Push  |                   |
|                | <b>0837 __ / _ Z</b> | <b>3.110,00 €</b> |
|                | Casambi              |                   |

**Materials**  
 Ball: Blowed glass. Glass fixation: Aluminum.  
 Ceiling rose: Steel. Diffuser: PC. Pendant structure: Steel.

**Light Source and electronics**  
 10 x LED 3,15 W 1050 mA  
 Constant Current 1050 mA  
 100~240V 50/60Hz

**Packaging**  
 2 Boxes  
 Total Vol. 0,3220 m<sup>3</sup>  
 Gross weight 15,5 Kg Net weight 10,5 Kg

**Notes**  
 Built-in

ø 10,5 cm

0840

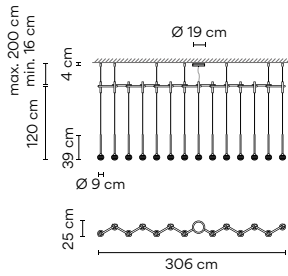

|  |                               |
|--|-------------------------------|
| <b>Finishes</b>                        | <b>LED temperature colour</b> |
| ● 18/ __ Graphite<br>(ADAPTA RF9913WX) | /1 _ 2700 K                   |
| ● 93/ __ White<br>(RAL 9016)           | /3 _ 3500 K                   |
|  | CRI >90 4371,92 lm 99 lm/W    |
|  | CRI >90 4371,92 lm 99,1 lm/W  |

|                |                      |                   |
|----------------|----------------------|-------------------|
| <b>Control</b> | <b>0840 __ / _ A</b> | <b>4.095,00 €</b> |
|                | DALI-2, 1-10V, Push  |                   |
|                | <b>0840 __ / _ Z</b> | <b>4.215,00 €</b> |
|                | Casambi              |                   |

**Materials**  
 Ball: Blowed glass. Glass fixation: Aluminum.  
 Ceiling rose: Steel. Diffuser: PC. Pendant structure: Steel.

**Light Source and electronics**  
 14 x LED 3,15 W 1050 mA  
 Constant Current 1050 mA  
 100~240V 50/60Hz

**Packaging**  
 3 Boxes  
 Total Vol. 0,5275 m<sup>3</sup>  
 Gross weight 17,3 Kg Net weight 11,3 Kg

**Notes**  
 Surface

0842

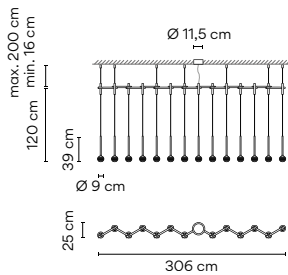

|  |                               |
|--|-------------------------------|
| <b>Finishes</b>                        | <b>LED temperature colour</b> |
| ● 18/ __ Graphite<br>(ADAPTA RF9913WX) | /1 _ 2700 K                   |
| ● 93/ __ White<br>(RAL 9016)           | /3 _ 3500 K                   |
|  | CRI >90 4371,92 lm 99 lm/W    |
|  | CRI >90 4371,92 lm 99,1 lm/W  |

|                |                      |                   |
|----------------|----------------------|-------------------|
| <b>Control</b> | <b>0842 __ / _ A</b> | <b>4.095,00 €</b> |
|                | DALI-2, 1-10V, Push  |                   |
|                | <b>0842 __ / _ Z</b> | <b>4.215,00 €</b> |
|                | Casambi              |                   |

**Materials**  
 Ball: Blowed glass. Glass fixation: Aluminum.  
 Ceiling rose: Steel. Diffuser: PC. Pendant structure: Steel.

**Light Source and electronics**  
 14 x LED 3,15 W 1050 mA  
 Constant Current 1050 mA  
 100~240V 50/60Hz

**Packaging**  
 3 Boxes  
 Total Vol. 0,5275 m<sup>3</sup>  
 Gross weight 17,3 Kg Net weight 11,3 Kg

**Notes**  
 Built-in

ø 10,5 cm

**0845**

**Finishes**  
 ● **18/** \_\_ Graphite (ADAPTA RF9913WX)  
 ● **93/** \_\_ White (RAL 9016)

**LED temperature colour**  
 /1\_ 2700 K CRI >90 4371,92 lm 99 lm/W  
 /3\_ 3500 K CRI >90 4371,92 lm 99,1 lm/W

**Control**  
**0845** \_\_ / \_\_ A 3.775,00 €  
 DALI-2, 1-10V, Push  
**0845** \_\_ / \_\_ Z 3.895,00 €  
 Casambi

**Materials**  
 Ball: Blowed glass. Glass fixation: Aluminum.  
 Ceiling rose: Steel. Diffuser: PC. Pendant structure: Steel.

**Light Source and electronics**  
 14 x LED 3,15 W 1050 mA  
 Constant Current 1050 mA  
 100~240V 50/60Hz

**Packaging**  
 2 Boxes  
 Total Vol. 0,3220 m<sup>3</sup>  
 Gross weight 18,3 Kg Net weight 13,3 Kg

**Notes**  
 Surface

**0847**

**Finishes**  
 ● **18/** \_\_ Graphite (ADAPTA RF9913WX)  
 ● **93/** \_\_ White (RAL 9016)

**LED temperature colour**  
 /1\_ 2700 K CRI >90 4371,92 lm 99 lm/W  
 /3\_ 3500 K CRI >90 4371,92 lm 99,1 lm/W

**Control**  
**0847** \_\_ / \_\_ A 3.775,00 €  
 DALI-2, 1-10V, Push  
**0847** \_\_ / \_\_ Z 3.895,00 €  
 Casambi

**Materials**  
 Ball: Blowed glass. Glass fixation: Aluminum.  
 Ceiling rose: Steel. Diffuser: PC. Pendant structure: Steel.

**Light Source and electronics**  
 14 x LED 3,15 W 1050 mA  
 Constant Current 1050 mA  
 100~240V 50/60Hz

**Packaging**  
 2 Boxes  
 Total Vol. 0,3220 m<sup>3</sup>  
 Gross weight 18,3 Kg Net weight 13,3 Kg

**Notes**  
 Built-in

**0850**

**Finishes**  
 ● **18/** \_\_ Graphite (ADAPTA RF9913WX)  
 ● **93/** \_\_ White (RAL 9016)

**LED temperature colour**  
 /1\_ 2700 K CRI >90 9056,12 lm 99 lm/W  
 /3\_ 3500 K CRI >90 9056,12 lm 99,1 lm/W

**Control**  
**0850** \_\_ / \_\_ A 7.475,00 €  
 DALI-2, 1-10V, Push  
**0850** \_\_ / \_\_ Z 7.595,00 €  
 Casambi

**Materials**  
 Ball: Blowed glass. Glass fixation: Aluminum.  
 Ceiling rose: Steel. Diffuser: PC. Pendant structure: Steel.

**Light Source and electronics**  
 29 x LED 3,15 W 1050 mA  
 Constant Current 1050 mA  
 100~240V 50/60Hz

**Packaging**  
 2 Boxes  
 Total Vol. 0,6260 m<sup>3</sup>  
 Gross weight 26 Kg Net weight 20 Kg

**Notes**  
 Surface

0852

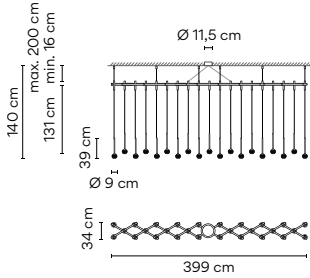

|   |                               |
|---|-------------------------------|
| <b>Finishes</b>                         | <b>LED temperature colour</b> |
| ● 18/ _ _ Graphite<br>(ADAPTA RF9913WX) | /1_ 2700 K                    |
| ● 93/ _ _ White<br>(RAL 9016)           | /3_ 3500 K                    |
|   | CRI >90 9056,12 lm 99 lm/W    |
|   | CRI >90 9056,12 lm 99,1 lm/W  |

|                |                      |                   |
|----------------|----------------------|-------------------|
| <b>Control</b> | <b>0852_ _ / _ A</b> | <b>7.530,00 €</b> |
|                | DALI-2, 1-10V, Push  |                   |
|                | <b>0852_ _ / _ Z</b> | <b>7.650,00 €</b> |
|                | Casambi              |                   |

**Materials**  
 Ball: Blowed glass. Glass fixation: Aluminum.  
 Ceiling rose: Steel. Diffuser: PC. Pendant structure: Steel.

**Light Source and electronics**  
 29 x LED 3,15 W 1050 mA  
 Constant Current 1050 mA  
 100~240V 50/60Hz

**Packaging**  
 2 Boxes  
 Total Vol. 0,6260 m<sup>3</sup>  
 Gross weight 26 Kg Net weight 20 Kg

**Notes**  
 Built-in  
  
 ø 10,5 cm

0855

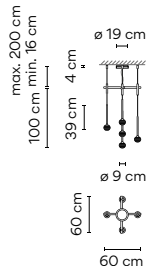

|   |                               |
|---|-------------------------------|
| <b>Finishes</b>                         | <b>LED temperature colour</b> |
| ● 18/ _ _ Graphite<br>(ADAPTA RF9913WX) | /1_ 2700 K                    |
| ● 93/ _ _ White<br>(RAL 9016)           | /3_ 3500 K                    |
|   | CRI >90 1561,4 lm 99 lm/W     |
|   | CRI >90 1130,4 lm 71,8 lm/W   |

|                |                      |                   |
|----------------|----------------------|-------------------|
| <b>Control</b> | <b>0855_ _ / _ A</b> | <b>1.625,00 €</b> |
|                | DALI-2, 1-10V, Push  |                   |
|                | <b>0855_ _ / _ Z</b> | <b>1.745,00 €</b> |
|                | Casambi              |                   |

**Materials**  
 Ball: Blowed glass. Glass fixation: Aluminum.  
 Ceiling rose: Steel. Diffuser: PC. Pendant structure: Steel.

**Light Source and electronics**  
 5 x LED 3,15 W 1050 mA  
 Constant Current 1050 mA  
 100~240V 50/60Hz

**Packaging**  
 2 Boxes  
 Total Vol. 0,115 m<sup>3</sup>  
 Gross weight 8,5 Kg Net weight 5,8 Kg

**Notes**  
 Surface.  
**UNTIL STOCK RUNS OUT**

0857

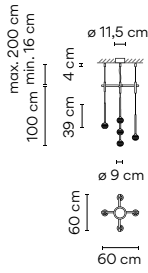

|   |                               |
|---|-------------------------------|
| <b>Finishes</b>                         | <b>LED temperature colour</b> |
| ● 18/ _ _ Graphite<br>(ADAPTA RF9913WX) | /1_ 2700 K                    |
| ● 93/ _ _ White<br>(RAL 9016)           | /3_ 3500 K                    |
|   | CRI >90 1561,4 lm 99 lm/W     |
|   | CRI >90 1130,4 lm 71,8 lm/W   |

|                |                      |                   |
|----------------|----------------------|-------------------|
| <b>Control</b> | <b>0857_ _ / _ A</b> | <b>1.625,00 €</b> |
|                | DALI-2, 1-10V, Push  |                   |
|                | <b>0857_ _ / _ Z</b> | <b>1.745,00 €</b> |
|                | Casambi              |                   |

**Materials**  
 Ball: Blowed glass. Glass fixation: Aluminum.  
 Ceiling rose: Steel. Diffuser: PC. Pendant structure: Steel.

**Light Source and electronics**  
 5 x LED 3,15 W 1050 mA  
 Constant Current 1050 mA  
 100~240V 50/60Hz

**Packaging**  
 2 Boxes  
 Total Vol. 0,115 m<sup>3</sup>  
 Gross weight 8,5 Kg Net weight 5,8 Kg

**Notes**  
 Built-in.  
**UNTIL STOCK RUNS OUT**  
  
 ø 10,5 cm

**0860**

**Finishes**

- **18/** \_ \_ Graphite (ADAPTA RF9913WX)
- **93/** \_ \_ White (RAL 9016)

**LED temperature colour**

- /1** \_ 2700 K CRI >90 4059,64 lm 99 lm/W
- /3** \_ 3500 K CRI >90 4059,64 lm 99,1 lm/W

**Control**

- 0860** \_ \_ / \_ A DALI-2, 1-10V, Push **3.315,00 €**
- 0860** \_ \_ / \_ Z Casambi **3.435,00 €**

**Materials**

Ball: Blowed glass. Glass fixation: Aluminum.  
Ceiling rose: Steel. Diffuser: PC. Pendant structure: Steel.

**Light Source and electronics**

13 x LED 3,15 W 1050 mA  
Constant Current 1050 mA  
100~240V 50/60Hz

**Packaging**

2 Boxes  
Total Vol. 0,3290 m<sup>3</sup>  
Gross weight 17,35 Kg Net weight 11,85 Kg

**Notes**

Surface

**0862**

**Finishes**

- **18/** \_ \_ Graphite (ADAPTA RF9913WX)
- **93/** \_ \_ White (RAL 9016)

**LED temperature colour**

- /1** \_ 2700 K CRI >90 4059,64 lm 99 lm/W
- /3** \_ 3500 K CRI >90 4059,64 lm 99,1 lm/W

**Control**

- 0862** \_ \_ / \_ A DALI-2, 1-10V, Push **3.315,00 €**
- 0862** \_ \_ / \_ Z Casambi **3.435,00 €**

**Materials**

Ball: Blowed glass. Glass fixation: Aluminum.  
Ceiling rose: Steel. Diffuser: PC. Pendant structure: Steel.

**Light Source and electronics**

13 x LED 3,15 W 1050 mA  
Constant Current 1050 mA  
100~240V 50/60Hz

**Packaging**

2 Boxes  
Total Vol. 0,3290 m<sup>3</sup>  
Gross weight 17,35 Kg Net weight 11,85 Kg

**Notes**

Built-in

**0865**

**Finishes**

- **18/** \_ \_ Graphite (ADAPTA RF9913WX)
- **93/** \_ \_ White (RAL 9016)

**LED temperature colour**

- /1** \_ 2700 K CRI >90 7807 lm 99 lm/W
- /3** \_ 3500 K CRI >90 7807 lm 99,1 lm/W

**Control**

- 0865** \_ \_ / \_ A DALI-2, 1-10V, Push **5.975,00 €**
- 0865** \_ \_ / \_ Z Casambi **6.095,00 €**

**Materials**

Ball: Blowed glass. Glass fixation: Aluminum.  
Ceiling rose: Steel. Diffuser: PC. Pendant structure: Steel.

**Light Source and electronics**

25 x LED 3,15 W 1050 mA  
Constant Current 1050 mA  
100~240V 50/60Hz

**Packaging**

2 Boxes  
Total Vol. 0,7280 m<sup>3</sup>  
Gross weight 25,25 Kg Net weight 20,25 Kg

**Notes**

Surface

0867

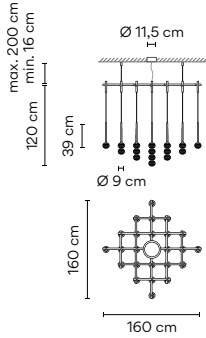

| Finishes                                | LED temperature colour                | Control                               |            |
|---|---------------------------------------|---------------------------------------|------------|
| ● 18/ _ _ Graphite<br>(ADAPTA RF9913WX) | /1_ 2700 K  CRI >90 7807 lm 99 lm/W   | 0867 _ _ / _ A<br>DALI-2, 1-10V, Push | 6.055,00 € |
| ● 93/ _ _ White<br>(RAL 9016)           | /3_ 3500 K  CRI >90 7807 lm 99,1 lm/W | 0867 _ _ / _ Z<br>Casambi             | 6.175,00 € |

Materials

Ball: Blowed glass. Glass fixation: Aluminum.  
 Ceiling rose: Steel. Diffuser: PC. Pendant structure: Steel.

Light Source and electronics

25 x LED 3,15 W 1050 mA  
 Constant Current 1050 mA  
 100~240V 50/60Hz

Packaging

2 Boxes  
 Total Vol. 0,7280 m<sup>3</sup>  
 Gross weight 25,25 Kg Net weight 20,25 Kg

Notes

Built-in



0870

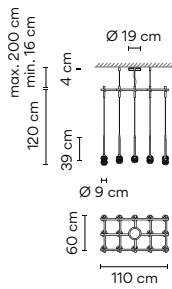

| Finishes                                | LED temperature colour                  | Control                               |            |
|---|---|---------------------------------------|------------|
| ● 18/ _ _ Graphite<br>(ADAPTA RF9913WX) | /1_ 2700 K  CRI >90 4684,2 lm 99 lm/W   | 0870 _ _ / _ A<br>DALI-2, 1-10V, Push | 3.845,00 € |
| ● 93/ _ _ White<br>(RAL 9016)           | /3_ 3500 K  CRI >90 4684,2 lm 99,1 lm/W | 0870 _ _ / _ Z<br>Casambi             | 3.965,00 € |

Materials

Ball: Blowed glass. Glass fixation: Aluminum.  
 Ceiling rose: Steel. Diffuser: PC. Pendant structure: Steel.

Light Source and electronics

15 x LED 3,15 W 1050 mA  
 Constant Current 1050 mA  
 100~240V 50/60Hz

Packaging

2 Boxes  
 Total Vol. 0,2679 m<sup>3</sup>  
 Gross weight 18,25 Kg Net weight 13,75 Kg

Notes

Surface



0872

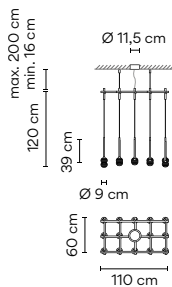

| Finishes                                | LED temperature colour                  | Control                               |            |
|---|---|---------------------------------------|------------|
| ● 18/ _ _ Graphite<br>(ADAPTA RF9913WX) | /1_ 2700 K  CRI >90 4684,2 lm 99 lm/W   | 0872 _ _ / _ A<br>DALI-2, 1-10V, Push | 3.845,00 € |
| ● 93/ _ _ White<br>(RAL 9016)           | /3_ 3500 K  CRI >90 4684,2 lm 99,1 lm/W | 0872 _ _ / _ Z<br>Casambi             | 3.965,00 € |

Materials

Ball: Blowed glass. Glass fixation: Aluminum.  
 Ceiling rose: Steel. Diffuser: PC. Pendant structure: Steel.

Light Source and electronics

15 x LED 3,15 W 1050 mA  
 Constant Current 1050 mA  
 100~240V 50/60Hz

Packaging

2 Boxes  
 Total Vol. 0,2679 m<sup>3</sup>  
 Gross weight 18,25 Kg Net weight 13,75 Kg

Notes

Built-in



0875

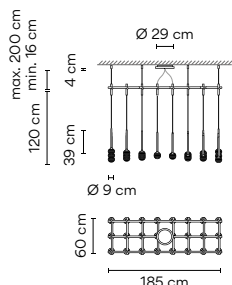

|   |                               |                              |
|---|-------------------------------|------------------------------|
| <b>Finishes</b>                               | <b>LED temperature colour</b> | <b>Control</b>               |
| ● <b>18/</b> __ Graphite<br>(ADAPTA RF9913WX) | <b>/1_</b> 2700 K <b>F</b>    | <b>0875</b> __ / __ <b>A</b> |
| ● <b>93/</b> __ White<br>(RAL 9016)           | <b>/3_</b> 3500 K <b>F</b>    | <b>0875</b> __ / __ <b>Z</b> |
|   | CRI >90 7494,72 lm 99 lm/W    | Casambi                      |
|   | CRI >90 7494,72 lm 99,1 lm/W  |                              |

**Materials**

Ball: Blowed glass. Glass fixation: Aluminum.  
Ceiling rose: Steel. Diffuser: PC. Pendant structure: Steel.

**Light Source and electronics**

24 x LED 3,15 W 1050 mA  
Constant Current 1050 mA  
100~240V 50/60Hz

**Packaging**

2 Boxes  
Total Vol. 0,4500 m<sup>3</sup>  
Gross weight 30,1 Kg Net weight 22,1 Kg

**Notes**

Surface



0877

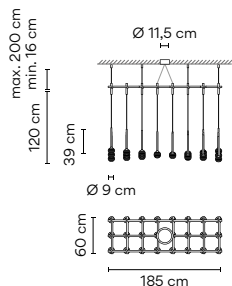

|   |                               |                              |
|---|-------------------------------|------------------------------|
| <b>Finishes</b>                               | <b>LED temperature colour</b> | <b>Control</b>               |
| ● <b>18/</b> __ Graphite<br>(ADAPTA RF9913WX) | <b>/1_</b> 2700 K <b>F</b>    | <b>0877</b> __ / __ <b>A</b> |
| ● <b>93/</b> __ White<br>(RAL 9016)           | <b>/3_</b> 3500 K <b>F</b>    | <b>0877</b> __ / __ <b>Z</b> |
|   | CRI >90 7494,72 lm 99 lm/W    | Casambi                      |
|   | CRI >90 7494,72 lm 99,1 lm/W  |                              |

**Materials**

Ball: Blowed glass. Glass fixation: Aluminum.  
Ceiling rose: Steel. Diffuser: PC. Pendant structure: Steel.

**Light Source and electronics**

24 x LED 3,15 W 1050 mA  
Constant Current 1050 mA  
100~240V 50/60Hz

**Packaging**

2 Boxes  
Total Vol. 0,4500 m<sup>3</sup>  
Gross weight 30,1 Kg Net weight 22,1 Kg

**Notes**

Built-in

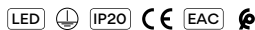

Bi-volt ø 10,5 cm

0880

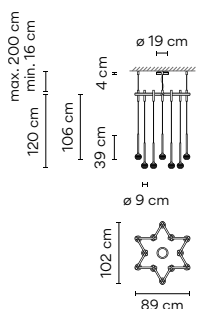

|   |                               |                              |
|---|-------------------------------|------------------------------|
| <b>Finishes</b>                               | <b>LED temperature colour</b> | <b>Control</b>               |
| ● <b>18/</b> __ Graphite<br>(ADAPTA RF9913WX) | <b>/1_</b> 2700 K <b>F</b>    | <b>0880</b> __ / __ <b>A</b> |
| ● <b>93/</b> __ White<br>(RAL 9016)           | <b>/3_</b> 3500 K <b>G</b>    | <b>0880</b> __ / __ <b>Z</b> |
|   | CRI >90 3747,4 lm 99 lm/W     | Casambi                      |
|   | CRI >90 2712,9 lm 71,8 lm/W   |                              |

**Materials**

Ball: Blowed glass. Glass fixation: Aluminum.  
Ceiling rose: Steel. Diffuser: PC. Pendant structure: Steel.

**Light Source and electronics**

12 x LED 3,15W 1050 mA  
Constant Current 1050 mA  
100~240V 50/60Hz

**Packaging**

2 Boxes  
Total Vol. 0,3290 m<sup>3</sup>  
Gross weight 16,5 Kg Net weight 11,4 Kg

**Notes**

Surface.

UNTIL STOCK RUNS OUT



0882

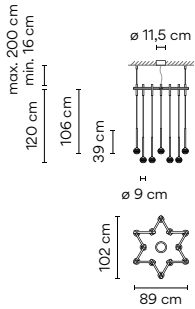

| Finishes                            | LED temperature colour                      | Control                           |            |
|-------------------------------------|---|-----------------------------------|------------|
| ● 18/ __ Graphite (ADAPTA RF9913WX) | /1_ 2700 K <b>F</b> >90 3747,4 lm 99 lm/W   | 0882 __ / _ A DALI-2, 1-10V, Push | 3.465,00 € |
| ● 93/ __ White (RAL 9016)           | /3_ 3500 K <b>G</b> >90 2712,9 lm 71,8 lm/W | 0882 __ / _ Z Casambi             | 3.585,00 € |

Materials

Ball: Blowed glass. Glass fixation: Aluminum.  
 Ceiling rose: Steel. Diffuser: PC. Pendant structure: Steel.

Light Source and electronics

12 x LED 3,15W 1050 mA  
 Constant Current 1050 mA  
 100~240V 50/60Hz

Packaging

2 Boxes  
 Total Vol. 0,3290 m<sup>3</sup>  
 Gross weight 16,5 Kg Net weight 11,4 Kg

Notes

Built-in.  
**UNTIL STOCK RUNS OUT**

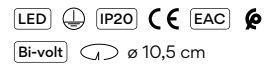

0885

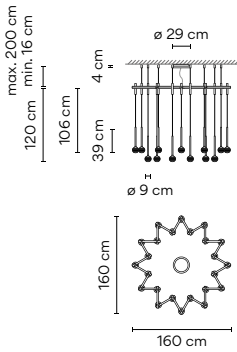

| Finishes                            | LED temperature colour                      | Control                           |            |
|-------------------------------------|---|-----------------------------------|------------|
| ● 18/ __ Graphite (ADAPTA RF9913WX) | /1_ 2700 K <b>F</b> >90 7494,7 lm 99 lm/W   | 0885 __ / _ A DALI-2, 1-10V, Push | 6.135,00 € |
| ● 93/ __ White (RAL 9016)           | /3_ 3500 K <b>G</b> >90 5425,9 lm 71,8 lm/W | 0885 __ / _ Z Casambi             | 6.255,00 € |

Materials

Ball: Blowed glass. Glass fixation: Aluminum.  
 Ceiling rose: Steel. Diffuser: PC. Pendant structure: Steel.

Light Source and electronics

24 x LED 3,15W 1050 mA  
 Constant Current 1050 mA  
 100~240V 50/60Hz

Packaging

2 Boxes  
 Total Vol. 0,7280 m<sup>3</sup>  
 Gross weight 25,25 Kg Net weight 20,25 Kg

Notes

Surface.  
**UNTIL STOCK RUNS OUT**



0887

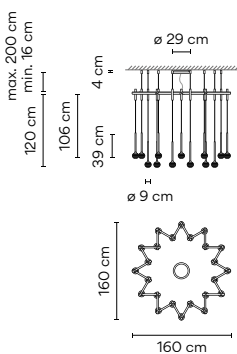

| Finishes                            | LED temperature colour                      | Control                           |            |
|-------------------------------------|---|-----------------------------------|------------|
| ● 18/ __ Graphite (ADAPTA RF9913WX) | /1_ 2700 K <b>F</b> >90 7494,7 lm 99 lm/W   | 0887 __ / _ A DALI-2, 1-10V, Push | 6.135,00 € |
| ● 93/ __ White (RAL 9016)           | /3_ 3500 K <b>G</b> >90 5425,9 lm 71,8 lm/W | 0887 __ / _ Z Casambi             | 6.255,00 € |

Materials

Ball: Blowed glass. Glass fixation: Aluminum.  
 Ceiling rose: Steel. Diffuser: PC. Pendant structure: Steel.

Light Source and electronics

24 x LED 3,15W 1050 mA  
 Constant Current 1050 mA  
 100~240V 50/60Hz

Packaging

2 Boxes  
 Total Vol. 0,7280 m<sup>3</sup>  
 Gross weight 25,25 Kg Net weight 20,25 Kg

Notes

Built-in.  
**UNTIL STOCK RUNS OUT**

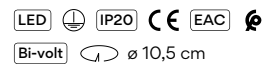

# Slim

Design by Jordi Vilardell

Elegant and magical, like drops of light falling from the sky, Slim's long, slender strands are suspended by fibre cords to draw the eye upwards.

---

## Pendants

**0916**

ø 40 cm



**0917**

ø 28 cm



**0935**

ø 69 cm



**0937**

53 x 26 cm



**0920**

ø 16 cm ø 16 cm



**0925**

ø 10 cm



**0931**

24 x 24 cm



**0933**

38 x 24 cm



**0940**

ø 100 cm

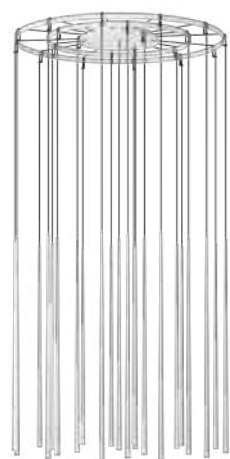





## 0916

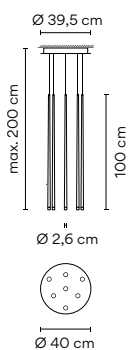

|   |   |            |                            |            |                           |            |                             |   |                       |            |                              |            |                          |            |
|---|---|------------|----------------------------|------------|---------------------------|------------|-----------------------------|---|-----------------------|------------|------------------------------|------------|--------------------------|------------|
| <p><b>Finishes</b></p> <ul style="list-style-type: none"> <li>● 10/ __ White (NCS S 0300-N)</li> <li>● 11/ __ Black (NCS S 8500-N)</li> <li>● 24/ __ Beige M1 (NCS S 2005-Y50R)</li> <li>● 37/ __ Terra Red (NCS S 4040-Y70R)</li> <li>● 47/ __ Green L1 (NCS S 4005-G80Y)</li> <li>● 68/ __ Ocre (NCS S 3050-Y30R)</li> </ul> <p><b>Finish customization</b><br/>(Available options:<br/>Vibia colour palette)</p> | <p><b>LED temperature colour</b></p> <table border="0"> <tr> <td>/1_ 2700 K </td> <td>CRI &gt;90 1268,54 lm 86 lm/W</td> </tr> <tr> <td>/2_ 3000 K </td> <td>CRI &gt;80 1142,4 lm 78 lm/W</td> </tr> <tr> <td>/3_ 3500 K </td> <td>CRI &gt;90 1453,5 lm 98,9 lm/W</td> </tr> </table> | /1_ 2700 K | CRI >90 1268,54 lm 86 lm/W | /2_ 3000 K | CRI >80 1142,4 lm 78 lm/W | /3_ 3500 K | CRI >90 1453,5 lm 98,9 lm/W | <p><b>Control</b></p> <table border="0"> <tr> <td>0916 __ / _ 1<br/>DALI</td> <td style="text-align: right;">2.175,00 €</td> </tr> <tr> <td>0916 __ / _ B<br/>1-10V, Push</td> <td style="text-align: right;">2.070,00 €</td> </tr> <tr> <td>0916 __ / _ Z<br/>Casambi</td> <td style="text-align: right;">2.190,00 €</td> </tr> </table> | 0916 __ / _ 1<br>DALI | 2.175,00 € | 0916 __ / _ B<br>1-10V, Push | 2.070,00 € | 0916 __ / _ Z<br>Casambi | 2.190,00 € |
| /1_ 2700 K  | CRI >90 1268,54 lm 86 lm/W  |            |                            |            |                           |            |                             |   |                       |            |                              |            |                          |            |
| /2_ 3000 K  | CRI >80 1142,4 lm 78 lm/W   |            |                            |            |                           |            |                             |   |                       |            |                              |            |                          |            |
| /3_ 3500 K  | CRI >90 1453,5 lm 98,9 lm/W   |            |                            |            |                           |            |                             |   |                       |            |                              |            |                          |            |
| 0916 __ / _ 1<br>DALI   | 2.175,00 €  |            |                            |            |                           |            |                             |   |                       |            |                              |            |                          |            |
| 0916 __ / _ B<br>1-10V, Push  | 2.070,00 €  |            |                            |            |                           |            |                             |   |                       |            |                              |            |                          |            |
| 0916 __ / _ Z<br>Casambi  | 2.190,00 €  |            |                            |            |                           |            |                             |   |                       |            |                              |            |                          |            |

**Materials**

Diffuser: Glass. Body: Fiberglass / Carbon fiber.  
Canopy Plate: Steel.

**Light Source and electronics**

7 x LED 2,1 W 700 mA  
Constant Current 700 mA  
110-240V 50/60Hz

**Packaging**

1 Box 0,22 x 0,48 x 1,20 m  
Vol 0,1278 m<sup>3</sup>  
Gross weight 13 Kg Net weight 9,6 Kg

**Notes**

Surface

Extra cable length. 16,00 €/m

**UNTIL STOCK RUNS OUT**

## 0917

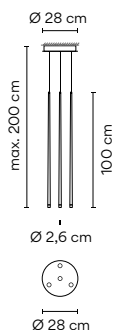

|   |  |            |                           |            |                          |            |                            |   |                       |            |                              |            |                          |            |
|---|--|------------|---------------------------|------------|--------------------------|------------|----------------------------|---|-----------------------|------------|------------------------------|------------|--------------------------|------------|
| <p><b>Finishes</b></p> <ul style="list-style-type: none"> <li>● 10/ __ White (NCS S 0300-N)</li> <li>● 11/ __ Black (NCS S 8500-N)</li> <li>● 24/ __ Beige M1 (NCS S 2005-Y50R)</li> <li>● 37/ __ Terra Red (NCS S 4040-Y70R)</li> <li>● 47/ __ Green L1 (NCS S 4005-G80Y)</li> <li>● 68/ __ Ocre (NCS S 3050-Y30R)</li> </ul> <p><b>Finish customization</b><br/>(Available options:<br/>Vibia colour palette)</p> | <p><b>LED temperature colour</b></p> <table border="0"> <tr> <td>/1_ 2700 K </td> <td>CRI &gt;90 724,88 lm 86 lm/W</td> </tr> <tr> <td>/2_ 3000 K </td> <td>CRI &gt;80 652,8 lm 78 lm/W</td> </tr> <tr> <td>/3_ 3500 K </td> <td>CRI &gt;90 830,6 lm 98,9 lm/W</td> </tr> </table> | /1_ 2700 K | CRI >90 724,88 lm 86 lm/W | /2_ 3000 K | CRI >80 652,8 lm 78 lm/W | /3_ 3500 K | CRI >90 830,6 lm 98,9 lm/W | <p><b>Control</b></p> <table border="0"> <tr> <td>0917 __ / _ 1<br/>DALI</td> <td style="text-align: right;">1.320,00 €</td> </tr> <tr> <td>0917 __ / _ B<br/>1-10V, Push</td> <td style="text-align: right;">1.255,00 €</td> </tr> <tr> <td>0917 __ / _ Z<br/>Casambi</td> <td style="text-align: right;">1.375,00 €</td> </tr> </table> | 0917 __ / _ 1<br>DALI | 1.320,00 € | 0917 __ / _ B<br>1-10V, Push | 1.255,00 € | 0917 __ / _ Z<br>Casambi | 1.375,00 € |
| /1_ 2700 K  | CRI >90 724,88 lm 86 lm/W  |            |                           |            |                          |            |                            |   |                       |            |                              |            |                          |            |
| /2_ 3000 K  | CRI >80 652,8 lm 78 lm/W   |            |                           |            |                          |            |                            |   |                       |            |                              |            |                          |            |
| /3_ 3500 K  | CRI >90 830,6 lm 98,9 lm/W   |            |                           |            |                          |            |                            |   |                       |            |                              |            |                          |            |
| 0917 __ / _ 1<br>DALI   | 1.320,00 €   |            |                           |            |                          |            |                            |   |                       |            |                              |            |                          |            |
| 0917 __ / _ B<br>1-10V, Push  | 1.255,00 €   |            |                           |            |                          |            |                            |   |                       |            |                              |            |                          |            |
| 0917 __ / _ Z<br>Casambi  | 1.375,00 €   |            |                           |            |                          |            |                            |   |                       |            |                              |            |                          |            |

**Materials**

Diffuser: Glass. Body: Fiberglass / Carbon fiber.  
Canopy Plate: Steel.

**Light Source and electronics**

4 x LED 2,1 W 700mA  
Constant Current 700 mA  
110-240V 50/60Hz

**Packaging**

1 Box 0,22 x 0,48 x 1,20 m  
Vol 0,1278 m<sup>3</sup>  
Gross weight 8 Kg Net weight 5,2 Kg

**Notes**

Surface

Extra cable length. 16,00 €/m

**UNTIL STOCK RUNS OUT**

## 0920

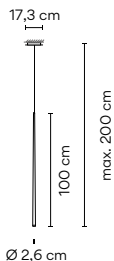

### Finishes

- 10/ \_\_ White (NCS S 0300-N)
- 11/ \_\_ Black (NCS S 8500-N)
- 24/ \_\_ Beige M1 (NCS S 2005-Y50R)
- 37/ \_\_ Terra Red (NCS S 4040-Y70R)
- 47/ \_\_ Green L1 (NCS S 4005-G80Y)
- 68/ \_\_ Ocre (NCS S 3050-Y30R)

Finish customization  
(Available options:  
Vibia colour palette)

### LED temperature colour

- /1\_ 2700 K F CRI >90 181,22 lm 86 lm/W
- /2\_ 3000 K G CRI >80 163,2 lm 78 lm/W
- /3\_ 3500 K F CRI >90 207,6 lm 98,9 lm/W

### Control

|                              |          |
|------------------------------|----------|
| 0920 __ / _ 0<br>On/ Off     | 350,00 € |
| 0920 __ / _ 1<br>DALI        | 370,00 € |
| 0920 __ / _ B<br>1-10V, Push | 370,00 € |
| 0920 __ / _ Z<br>Casambi     | 470,00 € |

### Materials

Diffuser: Glass. Body: Fiberglass / Carbon fiber.  
Canopy Plate: Steel.

### Light Source and electronics

1 x LED 2,1 W 700 mA  
Constant Current 700 mA  
100-240V 50/60Hz

### Packaging

1 Box 0,07 x 0,19 x 1,20 m  
Vol 0,0155 m<sup>3</sup>  
Gross weight 2,14 Kg Net weight 1,2 Kg

### Notes

Surface  
Extra cable length. 16,00 €/m

LED IP20 CE EAC Bi-volt

### Electrical connection

Surface  
\_18 Free Wire  
\_23 Built-in  
\_31 Remote  
Micro  
for plaster  
ceilings  
\_32 Remote  
XXS  
for all types  
of drop  
ceilings

## 0925

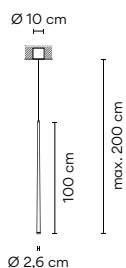

### Finishes

- 10/ \_\_ White (NCS S 0300-N)
- 11/ \_\_ Black (NCS S 8500-N)
- 24/ \_\_ Beige M1 (NCS S 2005-Y50R)
- 37/ \_\_ Terra Red (NCS S 4040-Y70R)
- 47/ \_\_ Green L1 (NCS S 4005-G80Y)
- 68/ \_\_ Ocre (NCS S 3050-Y30R)

Finish customization  
(Available options:  
Vibia colour palette)

### LED temperature colour

- /1\_ 2700 K F CRI >90 181,22 lm 86 lm/W
- /2\_ 3000 K G CRI >80 163,2 lm 78 lm/W
- /3\_ 3500 K F CRI >90 207,6 lm 98,9 lm/W

### Control

|                              |          |
|------------------------------|----------|
| 0925 __ / _ 0<br>On/ Off     | 350,00 € |
| 0925 __ / _ 1<br>DALI        | 370,00 € |
| 0925 __ / _ B<br>1-10V, Push | 370,00 € |
| 0925 __ / _ Z<br>Casambi     | 470,00 € |

### Materials

Diffuser: Glass. Body: Fiberglass / Carbon fiber.  
Canopy Plate: Steel.

### Light Source and electronics

1 x LED 2,1 W 700 mA  
Constant Current 700 mA  
100-240V 50/60Hz

### Packaging

1 Box 0,17 x 0,19 x 1,21 m  
Vol 0,0370 m<sup>3</sup>  
Gross weight 2,48 Kg Net weight 1,35 Kg

### Notes

Built-in  
Extra cable length. 16,00 €/m

**UNTIL STOCK RUNS OUT**

LED IP20 CE EAC Bi-volt

## 0931

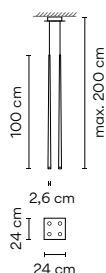

| Finishes                                | LED temperature colour                             |
|---|--|
| ● 10/ __ White<br>(NCS S 0300-N)        | /1 _ 2700 K <b>F</b><br>CRI >90 724,88 lm 86 lm/W  |
| ● 11/ __ Black<br>(NCS S 8500-N)        | /2 _ 3000 K <b>G</b><br>CRI >80 652,8 lm 78 lm/W   |
| ● 24/ __ Beige M1<br>(NCS S 2005-Y50R)  | /3 _ 3500 K <b>F</b><br>CRI >90 830,6 lm 98,9 lm/W |
| ● 37/ __ Terra Red<br>(NCS S 4040-Y70R) |  |
| ● 47/ __ Green L1<br>(NCS S 4005-G80Y)  |  |
| ● 68/ __ Ocre<br>(NCS S 3050-Y30R)      |  |

Finish customization  
(Available options:  
Vibia colour palette)

| Control                      |            |
|------------------------------|------------|
| 0931 __ / _ 1<br>DALI        | 990,00 €   |
| 0931 __ / _ B<br>1-10V, Push | 940,00 €   |
| 0931 __ / _ Z<br>Casambi     | 1.060,00 € |

## Materials

Diffuser: Glass. Body: Fiberglass / Carbon fiber.  
Canopy Plate: Steel.

## Light Source and electronics

4 x LED 2,1 W 700 mA  
Constant Current 700 mA  
100~240V 50/60Hz

## Packaging

1 Box 0,22 x 0,48 x 1,20 m  
Vol 0,1267 m<sup>3</sup>  
Gross weight 8 Kg Net weight 5,2 Kg

## Notes

Surface

Extra cable length. 16,00 €/m

**UNTIL STOCK RUNS OUT**

LED IP20 CE EAC Bi-volt

## 0933

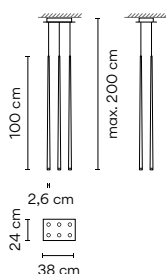

| Finishes                                | LED temperature colour                              |
|---|---|
| ● 10/ __ White<br>(NCS S 0300-N)        | /1 _ 2700 K <b>F</b><br>CRI >90 1087,32 lm 86 lm/W  |
| ● 11/ __ Black<br>(NCS S 8500-N)        | /2 _ 3000 K <b>G</b><br>CRI >80 979,2 lm 78 lm/W    |
| ● 24/ __ Beige M1<br>(NCS S 2005-Y50R)  | /3 _ 3500 K <b>F</b><br>CRI >90 1245,9 lm 98,9 lm/W |
| ● 37/ __ Terra Red<br>(NCS S 4040-Y70R) |   |
| ● 47/ __ Green L1<br>(NCS S 4005-G80Y)  |   |
| ● 68/ __ Ocre<br>(NCS S 3050-Y30R)      |   |

Finish customization  
(Available options:  
Vibia colour palette)

| Control                      |            |
|------------------------------|------------|
| 0933 __ / _ 1<br>DALI        | 1.415,00 € |
| 0933 __ / _ B<br>1-10V, Push | 1.345,00 € |
| 0933 __ / _ Z<br>Casambi     | 1.465,00 € |

## Materials

Diffuser: Glass. Body: Fiberglass / Carbon fiber.  
Canopy Plate: Steel.

## Light Source and electronics

6 x LED 2,1 W 700 mA  
Constant Current 700 mA  
110~240V 50/60Hz

## Packaging

1 Box 0,22 x 0,48 x 1,20 m  
Vol 0,1267 m<sup>3</sup>  
Gross weight 12,5 Kg Net weight 9,1 Kg

## Notes

Surface

Extra cable length. 16,00 €/m

**UNTIL STOCK RUNS OUT**

LED IP20 CE EAC Bi-volt

0935

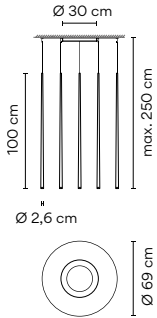

Finishes

- 10/ \_\_ White (NCS S 0300-N)
- 11/ \_\_ Black (NCS S 8500-N)
- 24/ \_\_ Beige M1 (NCS S 2005-Y50R)
- 37/ \_\_ Terra Red (NCS S 4040-Y70R)
- 47/ \_\_ Green L1 (NCS S 4005-G80Y)
- 68/ \_\_ Ocre (NCS S 3050-Y30R)

Finish customization  
 (Available options:  
 Vibia colour palette)

LED temperature colour

- /1 2700 K CRI >90 954,5 lm 95 lm/W
- /2 3000 K CRI >80 1140 lm 114 lm/W
- /3 3500 K CRI >90 1093,7 lm 109,4 lm/W

Control

|                              |            |
|------------------------------|------------|
| 0935 __ / _ 1<br>DALI-2      | 3.125,00 € |
| 0935 __ / _ B<br>1-10V, Push | 2.975,00 € |
| 0935 __ / _ Z<br>Casambi     | 3.095,00 € |

Materials

Diffuser: Glass. Body: Fiberglass / Carbon fiber.  
 Canopy Plate: Steel.

Light Source and electronics

10 x LED 1 W 350 mA  
 Constant Current 350 mA  
 110-240V 50/60Hz

Packaging

1 Box 1,14 x 1,14 x 0,34 m  
 Vol 0,4410 m<sup>3</sup>  
 Gross weight 19,2 Kg Net weight 14,2 Kg

Notes

Surface  
 Extra cable length. 16,00 €/m

UNTIL STOCK RUNS OUT



0937

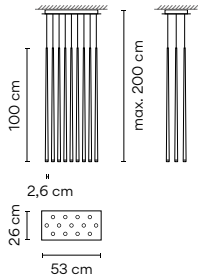

Finishes

- 10/ \_\_ White (NCS S 0300-N)
- 11/ \_\_ Black (NCS S 8500-N)
- 24/ \_\_ Beige M1 (NCS S 2005-Y50R)
- 37/ \_\_ Terra Red (NCS S 4040-Y70R)
- 47/ \_\_ Green L1 (NCS S 4005-G80Y)
- 68/ \_\_ Ocre (NCS S 3050-Y30R)

Finish customization  
 (Available options:  
 Vibia colour palette)

LED temperature colour

- /1 2700 K CRI >90 2355,86 lm 86 lm/W
- /2 3000 K CRI >80 2121,6 lm 78 lm/W
- /3 3500 K CRI >90 2699,4 lm 98,9 lm/W

Control

|                                    |            |
|------------------------------------|------------|
| 0937 __ / _ 1<br>DALI-2            | 2.555,00 € |
| 0937 __ / _ A<br>DALI, 1-10V, Push | 2.430,00 € |
| 0937 __ / _ Z<br>Casambi           | 2.550,00 € |

Materials

Diffuser: Glass. Body: Fiberglass / Carbon fiber.  
 Canopy Plate: Steel.

Light Source and electronics

13 x LED 2,1W 700mA  
 Constant Current 700 mA  
 110-240V 50/60Hz

Packaging

1 Box 0,22 x 0,48 x 1,20 m  
 Vol 0,1267 m<sup>3</sup>  
 Gross weight 12,5 Kg Net weight 18,46 Kg

Notes

Surface  
 Extra cable length. 16,00 €/m

UNTIL STOCK RUNS OUT



## 0940

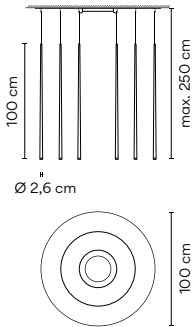

| Finishes  | LED temperature colour  | Control  |  |
|---|---|--|--|
| <ul style="list-style-type: none"> <li>● 10/ __ White (NCS S 0300-N)</li> <li>● 11/ __ Black (NCS S 8500-N)</li> <li>● 24/ __ Beige M1 (NCS S 2005-Y50R)</li> <li>● 37/ __ Terra Red (NCS S 4040-Y70R)</li> <li>● 47/ __ Green L1 (NCS S 4005-G80Y)</li> <li>● 68/ __ Ocre (NCS S 3050-Y30R)</li> </ul> | <ul style="list-style-type: none"> <li>/1 _ 2700 K  CRI &gt;90 2099,9 lm 95 lm/W</li> <li>/2 _ 3000 K  CRI &gt;80 2508 lm 114 lm/W</li> <li>/3 _ 3500 K  CRI &gt;90 2406,1 lm 109,4 lm/W</li> </ul> | <ul style="list-style-type: none"> <li>0940 __ / _ 1 DALI</li> <li>0940 __ / _ B 1-10V, Push</li> <li>0940 __ / _ Z Casambi</li> </ul> | <ul style="list-style-type: none"> <li>6.205,00 €</li> <li>5.905,00 €</li> <li>6.025,00 €</li> </ul> |
| <b>Finish customization</b><br>(Available options:<br>Vibia colour palette)   |   |  |  |

## Materials

Diffuser: Glass. Body: Fiberglass / Carbon fiber.  
Canopy Plate: Steel.

## Light Source and electronics

22 x LED 1W 350 mA  
Constant Current 350 mA  
110-240V 50/60Hz

## Packaging

1 Box 1,14 x 1,14 x 0,34 m  
Vol 0,4420 m<sup>3</sup>  
Gross weight 29,9 Kg Net weight 21,9 Kg

## Notes

Surface

Extra cable length. 16,00 €/m

**UNTIL STOCK RUNS OUT**

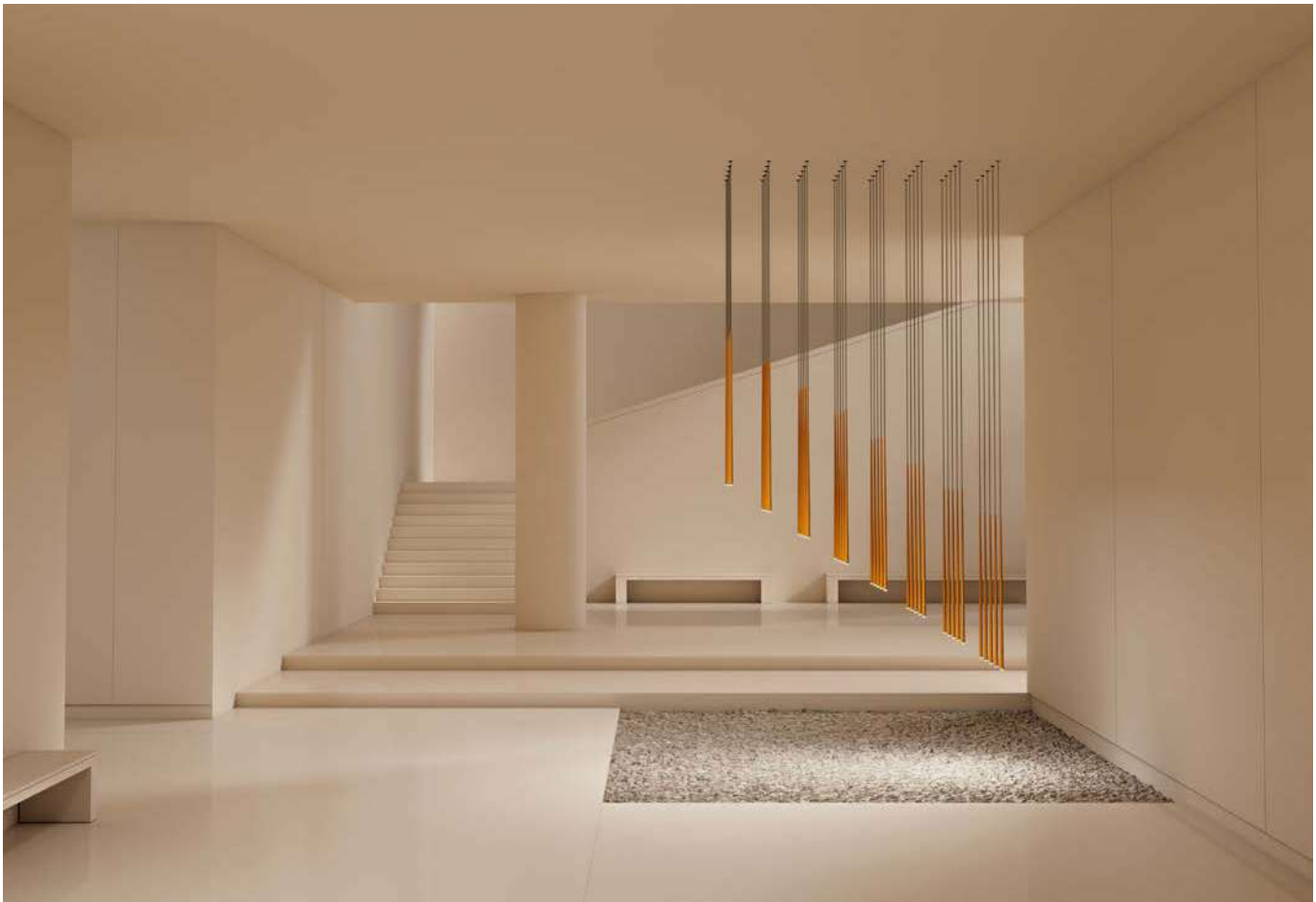

# Composing pendants

Next sketches are composed by one or more compositions

---

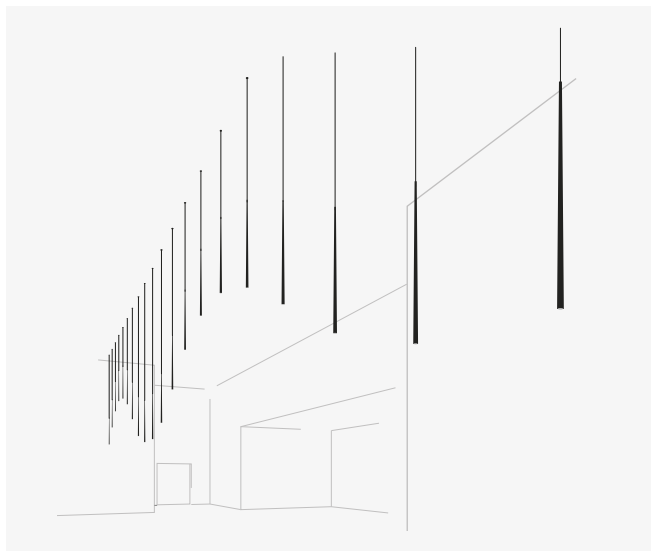

22 x 0920.

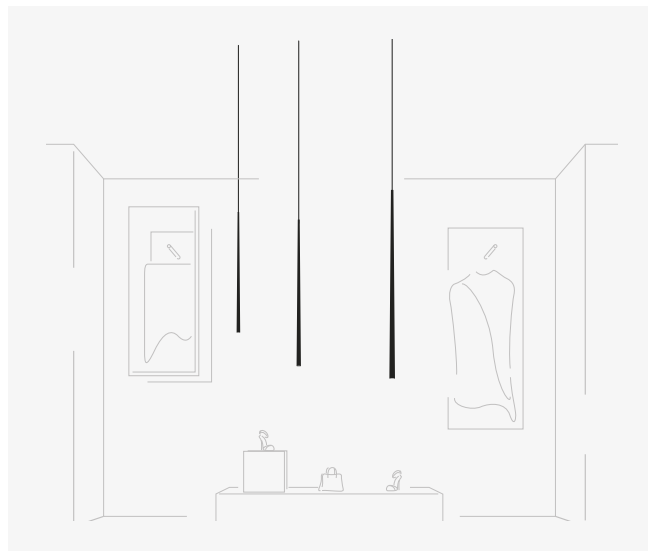

3 x 0920.

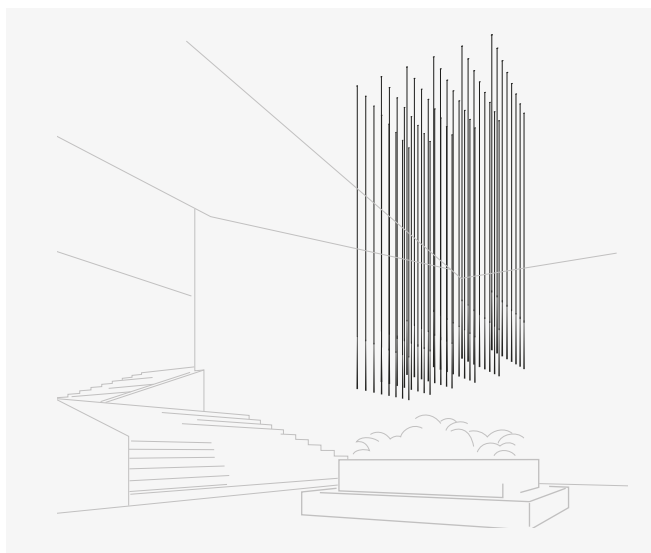

40 x 0920.

Each project is unique.  
Visit [vibia.com](http://vibia.com) and  
choose among multiple  
compositions designed  
and adapted to your  
project needs.

Personalise your own  
Slim composition quick  
and easy at [vibia.com](http://vibia.com)

# Electrical connection options for models 0920

Choose your preferred installation option according to your needs. For each composition, the optimal minimum number of drivers will be delivered.

## Drop ceiling

The innovative remote and built-in fittings accentuate the silkiness and lightness of compositions on suspended ceilings, its great visual grandeur taking center stage.

For Ref. 0920 \_\_ /10 / 0920 \_\_ /1B

### Remote

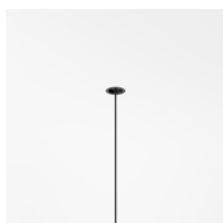

**Micro**  $\varnothing$  3 cm  
height 7 cm  
for plaster ceilings.  
Black finish.

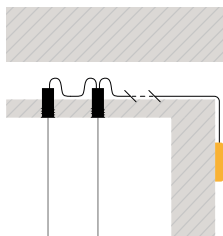

**XXS**  $\varnothing$  6 cm  
height 6 cm  
for all types of drop ceilings. Match with fixture finish.

### Built-in



$\varnothing$  8 cm  
height 6 cm  
match with fixture finish.

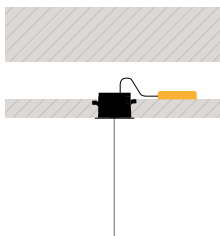



---

## Regular ceiling

When architecture does not allow for performance, surface and free wire showcase possibilities for any need or desire with no limits, ideal for both individual or cluster arrangements.

For Ref. 0920\_\_/10

### Surface



ø 17,3 cm  
match with  
fixture finish.

### Free Wire



1 - 3 wires

ø 20 cm



4 - 6 wires

ø 36 cm



7 - 9 wires

ø 40 cm

---

For Ref. 0920\_\_/1B / -1 / -Z

### Surface



ø 20 cm  
match with  
fixture finish.

### Free Wire



1 wire

ø 20 cm



2 - 6 wires

ø 36 cm



7 - 9 wires

ø 40 cm

you can choose the finish of the canopy  
among black, white or any colour  
matching one of the pendants.

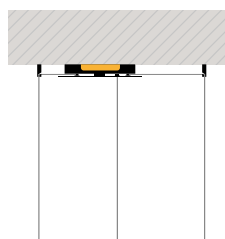
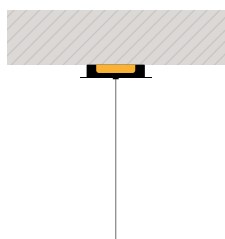

# Quadra Ice

Classic and timeless silhouette.  
Minimal presence. Integrates readily.

## Ceiling

1128 1138



42 cm

1134



66 cm

1128

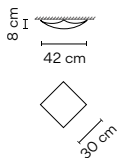

### Finishes

- 00 White glass (RAL 9016)

1128 00

195,00 €

### Materials

Ceiling support: Steel. Diffuser: Glass.

### Light Source and electronics

1 x R7s 80mm 230V 120 W Eco Max

### Packaging

1 Box 0,21 x 0,41 x 0,41 m

Vol 0,0353 m<sup>3</sup>

Gross weight 2,24 Kg Net weight 1,44 Kg

### Notes

UNTIL STOCK RUNS OUT



1134

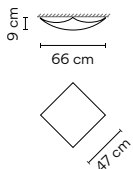

### Finishes

- 00 White glass (RAL 9016)

1134 00

235,00 €

### Materials

Ceiling support: Steel. Diffuser: Glass.

### Light Source and electronics

1 x R7s 117mm 230V 230 W Eco Max.

### Packaging

1 Box 0,27 x 0,60 x 0,60 m

Vol 0,0972 m<sup>3</sup>

Gross weight 6,2 Kg Net weight 4,2 Kg

### Notes

UNTIL STOCK RUNS OUT



1138

Finishes  
 ● 00/ \_ \_ White glass  
 (RAL 9016)

LED temperature colour  
 /1\_ 2700 K   
 CRI >90 1637,0 lm 99 lm/W

|                               |          |
|-------------------------------|----------|
| Control                       |          |
| 1138 _ _ / _ 1<br>DALI-2      | 460,00 € |
| 1138 _ _ / _ B<br>1-10V, Push | 435,00 € |
| 1138 _ _ / _ Z<br>Casambi     | 555,00 € |

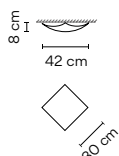

Materials  
 Ceiling support: Steel. Diffuser: Glass.

Light Source and electronics  
 1 x LED PLATE 16,5 W 500 mA  
 Constant Current 500 mA  
 110-240V 50/60Hz

Packaging  
 1 Box 0,21 x 0,41 x 0,41 m  
 Vol 0,0353 m<sup>3</sup>  
 Gross weight 2,24 Kg Net weight 1,65 Kg

Notes  
**UNTIL STOCK RUNS OUT**



# Top

Design by Ramos & Bassols

Soft, spherical shapes and a warm luminescence characterize the Top collection. Its glowing epicenter is encircled by a larger ring, lending the look of framing the light within its pure geometry.

## Ceiling Wall

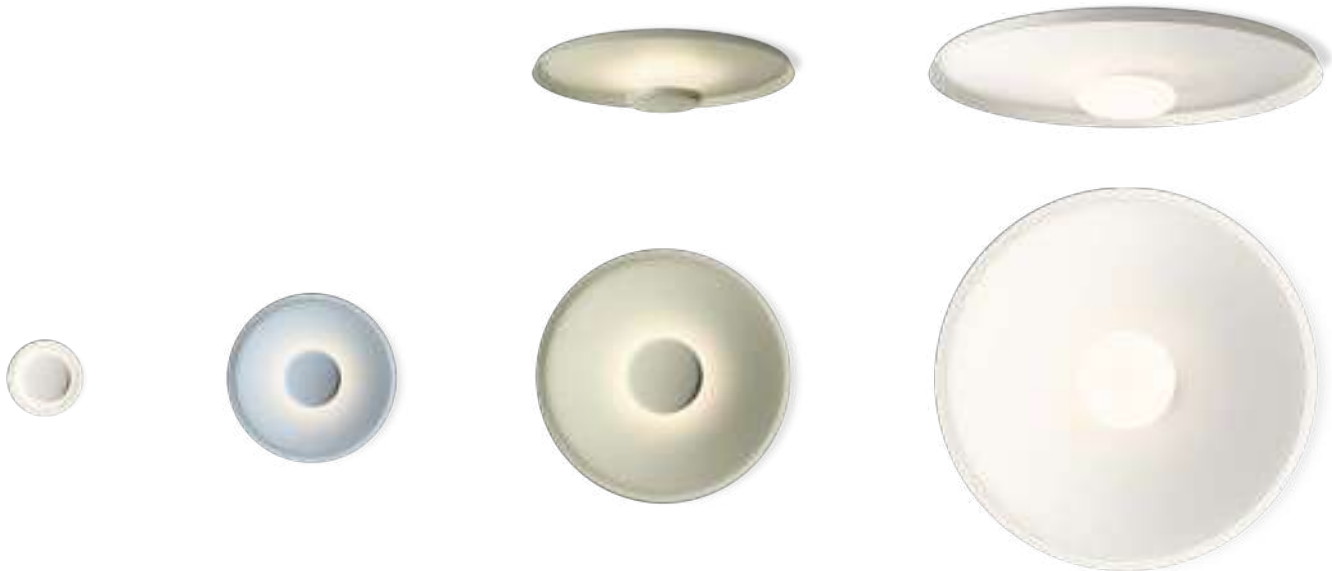

1154

ø 17 cm

1155

ø 40 cm

1160

ø 60 cm

1170

ø 90 cm

**1154**

6,2 cm  
11 cm  
Ø 17 cm

**Finishes**

- 10/ \_\_ White (NCS S 0300-N)
- 36/ \_\_ Soft pink (NCS S 1010-Y50R)
- 40/ \_\_ Blue L1 (NCS S 3010-B)
- 47/ \_\_ Green L1 (NCS S 4005-G80Y)

**ED temperature colour**

- /1 \_ 2700 K CRI >90 550 lm 100 lm/W
- /3 \_ 3500 K CRI >90 540,2 lm 98,2 lm/W

**Control**

1154 \_\_ / \_ 0  
On/ Off

**230,00 €**

---

**Materials**

Body: Aluminum.

**Light Source and electronics**

1 x LED PLATE 5,5 W 150 mA  
Constant Current 150 mA  
100~240V 50/60Hz

**Packaging**

1 Box 0,2 x 0,2 x 0,1 m  
Vol 0,004 m<sup>3</sup>  
Gross weight 0,8 Kg Net weight 0,5 Kg

LED IP20 Bi-volt

**1155**

10 cm  
13 cm  
Ø 40 cm

**Finishes**

- 10/ \_\_ White (NCS S 0300-N)
- 36/ \_\_ Soft pink (NCS S 1010-Y50R)
- 40/ \_\_ Blue L1 (NCS S 3010-B)
- 47/ \_\_ Green L1 (NCS S 4005-G80Y)

**ED temperature colour**

- /1 \_ 2700 K CRI >90 2050 lm 112 lm/W
- /3 \_ 3500 K CRI >90 2013,4 lm 110 lm/W

**Control**

1155 \_\_ / \_ 1 **510,00 €**  
DALI-2

1155 \_\_ / \_ B **485,00 €**  
1-10V, Push

1155 \_\_ / \_ Z **605,00 €**  
Casambi

---

**Materials**

Body: Aluminum.

**Light Source and electronics**

1 x LED PLATE 18,3 W 500 mA  
Constant Current 500 mA  
220~240V 50/60Hz

**Packaging**

1 Box 0,45 x 0,45 x 0,15 m  
Vol 0,03 m<sup>3</sup>  
Gross weight 1,8 Kg Net weight 1,5 Kg

LED IP20



1160

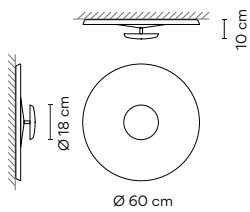

Finishes

- 10/ \_\_ White (NCS S 0300-N)
- 36/ \_\_ Soft pink (NCS S 1010-Y50R)
- 40/ \_\_ Blue L1 (NCS S 3010-B)
- 47/ \_\_ Green L1 (NCS S 4005-G80Y)

LED temperature colour

- /1 2700 K CRI >90 2880 lm 109 lm/W
- /3 3500 K CRI >90 2828,6 lm 107,1 lm/W

Control

- |                     |          |
|---------------------|----------|
| 1160 __ / _ A       | 645,00 € |
| DALI-2, 1-10V, Push |          |
| 1160 __ / _ Z       | 765,00 € |
| Casambi             |          |

Materials

Body: Aluminum.

Light Source and electronics  
 1 x LED PLATE 26,4 W 700 mA  
 Constant Current 700 mA  
 110-240V 50/60Hz

Packaging

1 Box 0,65 x 0,65 x 0,15 m  
 Vol 0,063 m<sup>3</sup>  
 Gross weight 3,13 Kg Net weight 2,5 Kg



1170

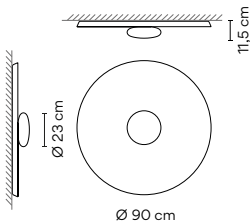

Finishes

- 10/ \_\_ White (NCS S 0300-N)
- 36/ \_\_ Soft pink (NCS S 1010-Y50R)
- 40/ \_\_ Blue L1 (NCS S 3010-B)
- 47/ \_\_ Green L1 (NCS S 4005-G80Y)

LED temperature colour

- /1 2700 K CRI >90 4056,81 lm 101 lm/W
- /3 3500 K CRI >90 4243,6 lm 105,6 lm/W

Control

- |                     |          |
|---------------------|----------|
| 1170 __ / _ A       | 865,00 € |
| DALI-2, 1-10V, Push |          |
| 1170 __ / _ Z       | 985,00 € |
| Casambi             |          |

Materials

Body: Aluminum. Diffuser: Triplex Opal Glass.

Light Source and electronics  
 3 x LED 13,4 W 700 mA  
 Constant Current 700 mA  
 220-240V 50/60Hz

Packaging

1 Box 1 x 1 x 0,2 m  
 Vol 0,02 m<sup>3</sup>  
 Gross weight 7,7 Kg Net weight 5,3 Kg



# Jazz

Design by Diego Fortunato

Sculptural design with a marked sensual but strong character.

Ancestral forms converted into modern design icons.

## Floor Table

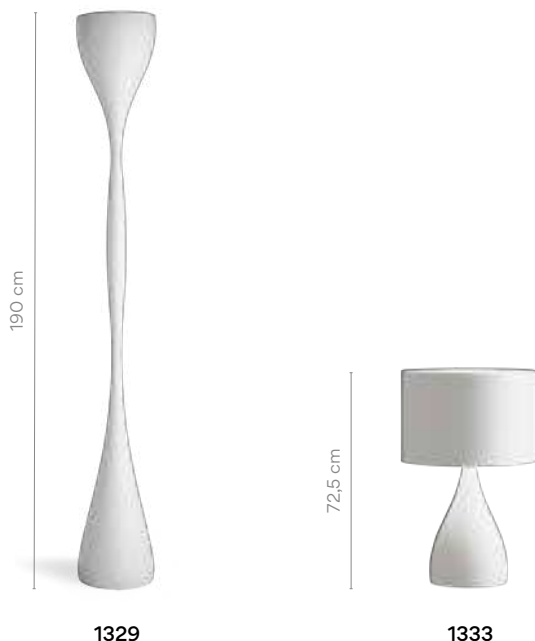

### 1329

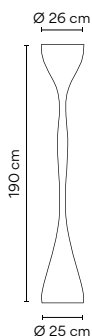

|  |   |
|--|---|
| <b>Finishes</b>  | <b>LED temperature colour</b>           |
| <ul style="list-style-type: none"> <li>● 10 White (NCS S 0300-N)</li> <li>● 25 Beige D1 (NCS S 4005-Y50R)</li> <li>● 45 Blue D1 (NCS S 7010-B10G)</li> </ul> | /1_ 2700 K<br>CRI >90 3736 lm 95,8 lm/W |

|                |            |
|----------------|------------|
| <b>Control</b> |            |
| 1329 __ / _ 5  | 1.915,00 € |
| 1329 __ / _ Z  | 2.035,00 € |
| Casambi        |            |

**Materials**  
Body: Polyurethane. Diffuser: Polycarbonate.

**Light Source and electronics**  
1 x LED PLATE 18,3 W 500 mA  
Constant Current 1050 mA  
100~240Vac 50/60Hz

**Packaging**  
2 Boxes 0,45 x 0,80 x 0,20 m  
Total Vol 0,1880 m<sup>3</sup>  
Gross weight 19,8 Kg Net weight 15 Kg

**Notes**  
Dimmer on the cable. Electric cable 2,5 m



### 1333

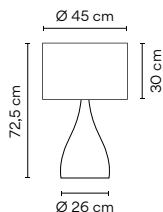

|  |                            |
|--|----------------------------|
| <b>Finishes</b>  | <b>LED 700 K 1520 lm/W</b> |
| <ul style="list-style-type: none"> <li>● 10 White (NCS S 0300-N)</li> <li>● 25 Beige D1 (NCS S 4005-Y50R)</li> <li>● 45 Blue D1 (NCS S 7010-B10G)</li> </ul> |                            |

|         |            |
|---------|------------|
| 1333 __ | 1.395,00 € |
|---------|------------|

**Materials**  
Body: Polyurethane. Diffuser: Optical-glass.  
Shade: Aluminum.

**Light Source and electronics**  
4 x LED E27 230V 12 W

**Packaging**  
1 Box 0,51 x 0,51 x 1,14 m  
Vol 0,2960 m<sup>3</sup>  
Gross weight 10 Kg Net weight 7,9 Kg

**Notes**  
Switch on the cable. Electric cable 1,5 m.

**UNTIL STOCK RUNS OUT**





# Flamingo

Design by Antoni Arola

Displaying the elegant poise of the bird that inspired it, Flamingo projects a feeling of weightlessness hovering overhead. The deconstructed design separates the LED light source from its translucent shades, producing gradations of diffuse illumination.

---

## Pendants

**1510**

ø 70 cm



**1515**

ø 70 cm



**1527**

ø 90 cm



**1530**

ø 90 cm



**1540**

ø 70 cm



**1550**

ø 90 cm



**1560**

ø 90 cm



**1570**

ø 90 cm





1510

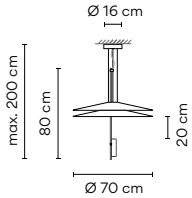

|  |  |   |                      |            |                           |            |                       |            |
|--|--|---|----------------------|------------|---------------------------|------------|-----------------------|------------|
| <p><b>Finishes</b></p> <ul style="list-style-type: none"> <li>● 18/ __ Graphite (RAL 7016)</li> <li>● 20/ __ Gold (Gold)</li> <li>● 67/ __ Copper (Copper)</li> <li>● 93/ __ White (RAL 9016)</li> </ul> | <p><b>LED temperature colour</b></p> <p>/1 _ 2700 K  CRI &gt;90 1108,02 lm 99 lm/W</p> <p>/3 3500 K  CRI &gt;90 1278,8 lm 114,2 lm/W</p> | <p><b>Control</b></p> <table border="0"> <tr> <td>1510 __ / _ 1 DALI-2</td> <td style="text-align: right;">1.185,00 €</td> </tr> <tr> <td>1510 __ / _ B 1-10V, Push</td> <td style="text-align: right;">1.125,00 €</td> </tr> <tr> <td>1510 __ / _ Z Casambi</td> <td style="text-align: right;">1.245,00 €</td> </tr> </table> | 1510 __ / _ 1 DALI-2 | 1.185,00 € | 1510 __ / _ B 1-10V, Push | 1.125,00 € | 1510 __ / _ Z Casambi | 1.245,00 € |
| 1510 __ / _ 1 DALI-2   | 1.185,00 €   |   |                      |            |                           |            |                       |            |
| 1510 __ / _ B 1-10V, Push  | 1.125,00 €   |   |                      |            |                           |            |                       |            |
| 1510 __ / _ Z Casambi  | 1.245,00 €   |   |                      |            |                           |            |                       |            |
| <p><b>Materials</b></p> <p>Diffuser: Methacrylate. Shade: Acrylic.<br/>         Body: Aluminum. Canopy and rods: Steel.</p>  |  | <p><b>Packaging</b></p> <p>2 Boxes<br/>         Total Vol 0,1320 m<sup>3</sup><br/>         Gross weight 8,7 Kg Net weight 7,8 Kg</p>   |                      |            |                           |            |                       |            |
| <p><b>Light Source and electronics</b></p> <p>2 x LED 5,6 W 500 mA<br/>         Constant Current 500 mA<br/>         110-240V 50/60Hz</p>  |  | <p><b>Notes</b></p> <p>Extra cable length. 16,00 €/m</p>  |                      |            |                           |            |                       |            |



1515

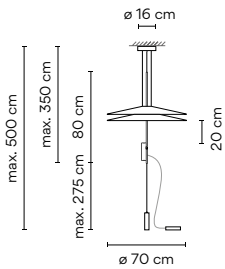

|  |  |  |                    |            |
|--|--|--|--------------------|------------|
| <p><b>Finishes</b></p> <ul style="list-style-type: none"> <li>● 18/ __ Graphite (RAL 7016)</li> <li>● 20/ __ Gold (Gold)</li> <li>● 67/ __ Copper (Copper)</li> <li>● 93/ __ White (RAL 9016)</li> </ul> | <p><b>LED temperature colour</b></p> <p>/1 _ 2700 K  CRI &gt;90 1108,02 lm 99 lm/W</p> <p>/3 3500 K  CRI &gt;90 1278,8 lm 114,2 lm/W</p> | <p><b>Control</b></p> <table border="0"> <tr> <td>1515 __ / _ 5 Push</td> <td style="text-align: right;">1.295,00 €</td> </tr> </table>            | 1515 __ / _ 5 Push | 1.295,00 € |
| 1515 __ / _ 5 Push   | 1.295,00 €   |  |                    |            |
| <p><b>Materials</b></p> <p>Diffuser: Methacrylate. Shade: Acrylic.<br/>         Body: Aluminum. Canopy and rods: Steel.</p>  |  | <p><b>Packaging</b></p> <p>2 Boxes<br/>         Total Vol 0,0620 m<sup>3</sup><br/>         Gross weight 7,2 Kg Net weight 5,2 Kg</p>              |                    |            |
| <p><b>Light Source and electronics</b></p> <p>2 x LED 5,6 W 500 mA<br/>         Constant Current 500 mA<br/>         110-240V 50/60Hz</p>  |  | <p><b>Notes</b></p> <p>Dimmer on the cable. Electric cable 2,5 m<br/>         Extra cable length. 16,00 €/m</p> <p><b>UNTIL STOCK RUNS OUT</b></p> |                    |            |



1527

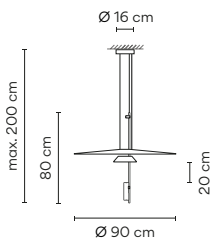

|  |  |   |                      |            |                           |            |                       |            |
|--|--|---|----------------------|------------|---------------------------|------------|-----------------------|------------|
| <p><b>Finishes</b></p> <ul style="list-style-type: none"> <li>● 18/ __ Graphite (RAL 7016)</li> <li>● 20/ __ Gold (Gold)</li> <li>● 67/ __ Copper (Copper)</li> <li>● 93/ __ White (RAL 9016)</li> </ul> | <p><b>LED temperature colour</b></p> <p>/1 _ 2700 K  CRI &gt;90 1108,02 lm 99 lm/W</p> <p>/3 3500 K  CRI &gt;90 1278,8 lm 114,2 lm/W</p> | <p><b>Control</b></p> <table border="0"> <tr> <td>1527 __ / _ 1 DALI-2</td> <td style="text-align: right;">1.305,00 €</td> </tr> <tr> <td>1527 __ / _ B 1-10V, Push</td> <td style="text-align: right;">1.240,00 €</td> </tr> <tr> <td>1527 __ / _ Z Casambi</td> <td style="text-align: right;">1.360,00 €</td> </tr> </table> | 1527 __ / _ 1 DALI-2 | 1.305,00 € | 1527 __ / _ B 1-10V, Push | 1.240,00 € | 1527 __ / _ Z Casambi | 1.360,00 € |
| 1527 __ / _ 1 DALI-2   | 1.305,00 €   |   |                      |            |                           |            |                       |            |
| 1527 __ / _ B 1-10V, Push  | 1.240,00 €   |   |                      |            |                           |            |                       |            |
| 1527 __ / _ Z Casambi  | 1.360,00 €   |   |                      |            |                           |            |                       |            |
| <p><b>Materials</b></p> <p>Diffuser: Methacrylate. Shade: Acrylic.<br/>         Body: Aluminum. Canopy and rods: Steel.</p>  |  | <p><b>Packaging</b></p> <p>1 Box 0,12 x 0,80 x 0,79 m<br/>         Vol 0,0634 m<sup>3</sup><br/>         Gross weight 4,1 Kg Net weight 3,69 Kg</p>   |                      |            |                           |            |                       |            |
| <p><b>Light Source and electronics</b></p> <p>2 x LED 5,6 W 500 mA<br/>         Constant Current 500 mA<br/>         110-240V 50/60Hz</p>  |  | <p><b>Notes</b></p> <p>Extra cable length. 16,00 €/m</p>  |                      |            |                           |            |                       |            |



# Flamingo

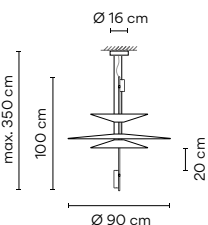

**1530**



**Finishes**

- **18/** \_\_ Graphite (RAL 7016)
- **20/** \_\_ Gold (Gold)
- **67/** \_\_ Copper (Copper)
- **93/** \_\_ White (RAL 9016)

**LED temperature colour**

- /1** \_ 2700 K  CRI >90 1662,03 lm 99 lm/W
- /3** \_ 3500 K  CRI >90 1918,2 lm 114,2 lm/W

**Control**



|                                  |                   |
|----------------------------------|-------------------|
| <b>1530</b> __ / _ 1 DALI-2      | <b>1.645,00 €</b> |
| <b>1530</b> __ / _ B 1-10V, Push | <b>1.565,00 €</b> |
| <b>1530</b> __ / _ Z Casambi     | <b>1.685,00 €</b> |

**Materials**  
Diffuser: Methacrylate. Shade: Acrylic.  
Body: Aluminum. Canopy and rods: Steel.

**Light Source and electronics**  
3 x LED 5,6 W 500 mA  
Constant Current 500 mA  
220-240V 50/60Hz

**Packaging**  
3 Boxes  
Total Vol 0,1520 m<sup>3</sup>  
Gross weight 10 Kg Net weight 7 Kg

**Notes**  
Extra cable length. **16,00 €/m**

**LED**  **IP20**  **EAC** 

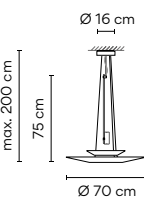

**1540**



**Finishes**

- **18/** \_\_ Graphite (RAL 7016)
- **20/** \_\_ Gold (Gold)
- **67/** \_\_ Copper (Copper)
- **93/** \_\_ White (RAL 9016)

**LED temperature colour**

- /1** \_ 2700 K  CRI >90 554,01 lm 99 lm/W
- /3** \_ 3500 K  CRI >90 639,4 lm 114,2 lm/W

**Control**



|                                  |                   |
|----------------------------------|-------------------|
| <b>1540</b> __ / _ 1 DALI-2      | <b>1.085,00 €</b> |
| <b>1540</b> __ / _ B 1-10V, Push | <b>1.030,00 €</b> |
| <b>1540</b> __ / _ Z Casambi     | <b>1.150,00 €</b> |

**Materials**  
Diffuser: Methacrylate. Shade: Acrylic.  
Body: Aluminum. Canopy and rods: Steel.

**Light Source and electronics**  
1 x LED 5,6 W 500 mA  
Constant Current 500 mA  
110-240V 50/60Hz

**Packaging**  
2 Boxes  
Total Vol 0,0620 m<sup>3</sup>  
Gross weight 6 Kg Net weight 4 Kg

**Notes**  
Extra cable length. **16,00 €/m**

**LED**  **IP20**  **EAC**  **Bi-volt**

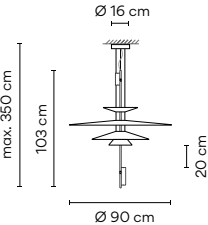

**1550**



**Finishes**

- **18/** \_\_ Graphite (RAL 7016)
- **20/** \_\_ Gold (Gold)
- **67/** \_\_ Copper (Copper)
- **93/** \_\_ White (RAL 9016)

**LED temperature colour**

- /1** \_ 2700 K  CRI >90 1662,03 lm 99 lm/W
- /3** \_ 3500 K  CRI >90 1918,2 lm 114,2 lm/W

**Control**



|                                  |                   |
|----------------------------------|-------------------|
| <b>1550</b> __ / _ 1 DALI-2      | <b>1.700,00 €</b> |
| <b>1550</b> __ / _ B 1-10V, Push | <b>1.615,00 €</b> |
| <b>1550</b> __ / _ Z Casambi     | <b>1.735,00 €</b> |

**Materials**  
Diffuser: Methacrylate. Shade: Acrylic.  
Body: Aluminum. Canopy and rods: Steel.

**Light Source and electronics**  
3 x LED 5,6 W 500 mA  
Constant Current 500 mA  
220-240V 50/60Hz

**Packaging**  
3 Boxes  
Total Vol 0,1520 m<sup>3</sup>  
Gross weight 11,3 Kg Net weight 8,8 Kg

**Notes**  
Extra cable length. **16,00 €/m**

**LED**  **IP20**  **EAC** 

1560

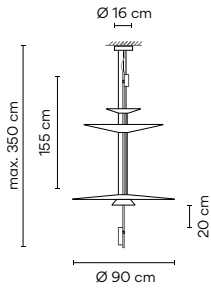

- Finishes**
- 18/ \_\_ Graphite (RAL 7016)
  - 20/ \_\_ Gold (Gold)
  - 67/ \_\_ Copper (Copper)
  - 93/ \_\_ White (RAL 9016)

- LED temperature colour**
- /1 \_ 2700 K CRI >90 1662,03 lm 99 lm/W
  - /3 3500 K CRI >90 1918,2 lm 114,2 lm/W

**Control**

|                           |            |
|---------------------------|------------|
| 1560 __ / _ 1 DALI-2      | 1.805,00 € |
| 1560 __ / _ B 1-10V, Push | 1.715,00 € |
| 1560 __ / _ Z Casambi     | 1.835,00 € |

**Materials**  
 Diffuser: Methacrylate. Shade: Acrylic.  
 Body: Aluminum. Canopy and rods: Steel.

**Light Source and electronics**  
 3 x LED 5,6 W 500 mA  
 Constant Current 500 mA  
 220-240V 50/60Hz

**Packaging**  
 3 Boxes  
 Total Vol 0,1860 m<sup>3</sup>  
 Gross weight 12,7 Kg Net weight 10,2 Kg

**Notes**  
 Extra cable length. 16,00 €/m

LED IP20 CE EAC

1570

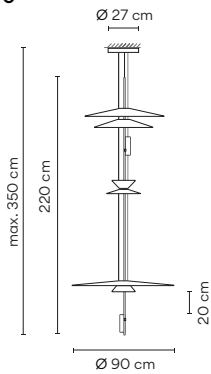

- Finishes**
- 18/ \_\_ Graphite (RAL 7016)
  - 20/ \_\_ Gold (Gold)
  - 67/ \_\_ Copper (Copper)
  - 93/ \_\_ White (RAL 9016)

- LED temperature colour**
- /1 \_ 2700 K CRI >90 2216,04 lm 99 lm/W
  - /3 3500 K CRI >90 2557,6 lm 114,2 lm/W

**Control**

|                           |            |
|---------------------------|------------|
| 1570 __ / _ 1 DALI-2      | 2.290,00 € |
| 1570 __ / _ B 1-10V, Push | 2.180,00 € |
| 1570 __ / _ Z Casambi     | 2.300,00 € |

**Materials**  
 Diffuser: Methacrylate. Shade: Acrylic.  
 Body: Aluminum. Canopy and rods: Steel.

**Light Source and electronics**  
 4 x LED 5,6 W 500 mA  
 Constant Current 500 mA  
 110-240V 50/60Hz

**Packaging**  
 2 Boxes  
 Total Vol 0,1633 m<sup>3</sup>  
 Gross weight 10 Kg Net weight 8,64 Kg

**Notes**  
 Extra cable length. 16,00 €/m

LED IP20 CE EAC



# Flamingo Mini

Design by Antoni Arola

Flamingo Mini creates multi-layered silhouettes with an avant-garde, intriguing aesthetic. This hanging lamp recalls a bird hovering overhead, bringing an intimate ambience as it casts diffuse gradations of soothing light through its translucent diffuser.

## Pendants

1575

Ø 45 cm

1580

Ø 9 cm

1585

Ø 45 cm

1590

Ø 45 cm

Option A

Option B

Option C



Three options of installation



1575

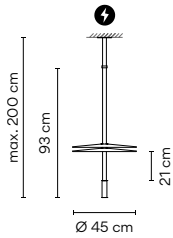

**Finishes**  
 ● 11/ \_ \_ Black (NCS S 8500-N)

**LED Colour Temperature**  
 /1 \_ 2700 K CRI >90 726 lm 124 lm/W

**Control**

|                            |          |
|----------------------------|----------|
| 1575 _ _ / _ 1 DALI-2      | 790,00 € |
| 1575 _ _ / _ B Push; 1-10V | 750,00 € |
| 1575 _ _ / _ Z Casambi     | 870,00 € |

**Materials**  
 Diffuser: PMMA. Rods: Stainless steel.  
 Body: Aluminum. Canopy: ABS.

**Light Source and electronics**  
 2 x LED 3W 175 mA  
 Constant current 350 mA  
 110-240Vac 50/60Hz

**Packaging**  
 2 Boxes  
 Box 1: 0,07 x 0,07 x 1,25 m  
 Box 2: 0,51 x 0,51 x 0,16 m  
 Total Vol 0,0478 m<sup>3</sup>  
 Gross weight 5,5 Kg Net weight 4 Kg

**Notes**  
 Additional cable length personalisation 16,00 €/m

LED IP20 CE EAC Bi-volt

Select Electrical connection Surface \_23 Built-in XS

1580

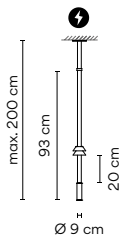

**Finishes**  
 ● 11/ \_ \_ Black (NCS S 8500-N)

**LED Colour Temperature**  
 /1 \_ 2700 K CRI >90 726 lm 124 lm/W

**Control**

|                            |          |
|----------------------------|----------|
| 1580 _ _ / _ 1 DALI-2      | 710,00 € |
| 1580 _ _ / _ B Push; 1-10V | 675,00 € |
| 1580 _ _ / _ Z Casambi     | 795,00 € |

**Materials**  
 Diffuser: PMMA. Rods: Stainless steel.  
 Body: Aluminum. Canopy: ABS.

**Light Source and electronics**  
 2 x LED 3W 175 mA  
 Constant current 350 mA  
 110-240Vac 50/60Hz

**Packaging**  
 2 Boxes  
 Box 1: 0,068 x 0,068 x 1,25 m  
 Box 2: 0,20 x 0,21 x 0,13 m  
 Total Vol 0,0112 m<sup>3</sup>  
 Gross weight 4 Kg Net weight 3 Kg

**Notes**  
 Additional cable length personalisation 16,00 €/m

LED IP20 CE EAC Bi-volt

Select Electrical connection Surface \_23 Built-in XS

1585

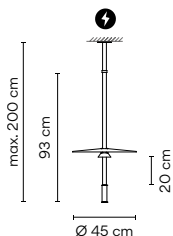

**Finishes**  
 ● 11/ \_ \_ Black (NCS S 8500-N)

**LED Colour Temperature**  
 /1 \_ 2700 K CRI >90 726 lm 124 lm/W

**Control**

|                            |          |
|----------------------------|----------|
| 1585 _ _ / _ 1 DALI-2      | 765,00 € |
| 1585 _ _ / _ B Push; 1-10V | 725,00 € |
| 1585 _ _ / _ Z Casambi     | 845,00 € |

**Materials**  
 Diffuser: PMMA. Rods: Stainless steel.  
 Body: Aluminum. Canopy: ABS.

**Light Source and electronics**  
 2 x LED 3W 175 mA  
 Constant current 350 mA  
 110-240Vac 50/60Hz

**Packaging**  
 2 Boxes  
 Box 1: 0,07 x 0,07 x 1,25 m  
 Box 2: 0,51 x 0,51 x 0,16 m  
 Total Vol 0,0478 m<sup>3</sup>  
 Gross weight 5,5 Kg Net weight 4 Kg

**Notes**  
 Additional cable length personalisation 16,00 €/m

LED IP20 CE EAC Bi-volt

Select Electrical connection Surface \_23 Built-in XS

1590

**Finishes**  
 ● 11/ \_ \_ Black (NCS S 8500-N)

**LED Colour Temperature**  
 /1 \_ 2700 K  CRI>90 1152 lm 132 lm/W

**Control**  
 1590 \_ \_ / \_ 1 1.045,00 €  
 DALI-2  
 1590 \_ \_ / \_ B 995,00 €  
 Push; 1-10V  
 1590 \_ \_ / \_ Z 1.115,00 €  
 Casambi

 Select Electrical connection  
 Surface  
 \_23 Built-in XS

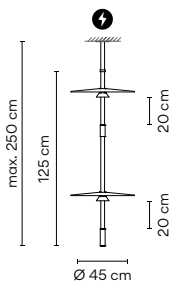

**Materials**  
 Diffuser: PMMA. Rods: Stainless steel.  
 Body: Aluminum. Canopy: ABS.

**Light Source and electronics**  
 3 x LED COB 3W 185 mA  
 Constant Current 550 mA  
 110-240Vac 50/60Hz

**Packaging**  
 2 Boxes  
 Box 1: 0,07 x 0,07 x 1,60 m  
 Box 2: 0,51 x 0,51 x 0,16 m  
 Total Vol 0,0494 m<sup>3</sup>  
 Gross weight 6,5 Kg Net weight 5 Kg

**Notes**  
 Additional cable length personalisation 16,00 €/m

  IP20    Bi-volt

## Electrical connection options

Choose your preferred installation option according to your needs.

Drop ceiling

Regular ceiling

\_23 Built-in XS



Ø 8 cm  
 height 6 cm  
 black finish.

Surface



Ø 10 cm  
 black finish.



# Pin

Design by Ichiro Iwasaki

Through the exploration of “eternal comfort” in lighting environments PIN aims to provide something new and original yet in harmony with both the old and the contemporary.

## Table



|   |   |  |  |
|---|---|--|--|
| <p><b>1650</b></p>  | <p><b>Finishes</b></p> <ul style="list-style-type: none"> <li>● <b>04/</b> __ Black (NCS 9000N)</li> <li>● <b>58/</b> __ Cream (NCS S 2005-Y20R)</li> <li>● <b>62/</b> __ Green (NCS S 3010-G20Y)</li> <li>● <b>93/</b> __ White (NCS S 0502-Y)</li> </ul> <p><b>Finish customization</b><br/>(Available options:<br/>Vibia colour palette)</p> | <p><b>LED temperature colour</b></p> <p><b>/1_</b> 2700 K  <b>E</b></p> <p>CRI &gt;90 485 lm 121 lm/W</p>                          | <p><b>Control</b></p> <p><b>1650</b> __ / __ <b>0</b></p> <p>On/ Off</p> <p style="text-align: right;"><b>460,00 €</b></p> |
| <p><b>1655</b></p>  | <p><b>Finishes</b></p> <ul style="list-style-type: none"> <li>● <b>04/</b> __ Black (NCS 9000N)</li> <li>● <b>58/</b> __ Cream (NCS S 2005-Y20R)</li> <li>● <b>62/</b> __ Green (NCS S 3010-G20Y)</li> <li>● <b>93/</b> __ White (NCS S 0502-Y)</li> </ul> <p><b>Finish customization</b><br/>(Available options:<br/>Vibia colour palette)</p> | <p><b>LED temperature colour</b></p> <p><b>/1_</b> 2700 K  <b>E</b></p> <p>CRI &gt;90 485 lm 121 lm/W</p>                          | <p><b>Control</b></p> <p><b>1655</b> __ / __ <b>0</b></p> <p>On/ Off</p> <p style="text-align: right;"><b>475,00 €</b></p> |
| <p><b>Materials</b></p> <p>Head: Aluminum. Base: Zamak.<br/>Diffuser: Polycarbonate. Rod: Steel.</p>                    |   | <p><b>Packaging</b></p> <p>1 Box 0,174 x 0,212 x 0,713 m<br/>Vol 0,0212 m<sup>3</sup><br/>Gross weight 2,94 Kg Net weight 2 Kg</p> |  |
| <p><b>Light Source and electronics</b></p> <p>1 x LED 4,5 W 350 mA<br/>Constant Current 350 mA<br/>100~240V 50/60Hz</p> |   | <p><b>Notes</b></p> <p>Switch on the base. Electric cable 3 m.</p> <p> </p>  |  |
| <p><b>Materials</b></p> <p>Head: Aluminum. Base: Zamak.<br/>Diffuser: Polycarbonate. Rod: Steel.</p>                    |   | <p><b>Packaging</b></p> <p>1 Box 0,20 x 0,357 x 0,67 m<br/>Vol 0,0480 m<sup>3</sup><br/>Gross weight 3,68 Kg Net weight 2,2 Kg</p> |  |
| <p><b>Light Source and electronics</b></p> <p>1 x LED 4,5 W 350 mA<br/>Constant Current 350 mA<br/>100~240V 50/60Hz</p> |   | <p><b>Notes</b></p> <p>Switch on the base. Electric cable 3 m.</p> <p> </p>  |  |





Floor



|  |   |  |   |
|--|---|--|---|
| <p><b>1660</b></p>   | <p><b>Finishes</b></p> <ul style="list-style-type: none"> <li>● <b>04/</b> __ Black (NCS 9000N)</li> <li>● <b>58/</b> __ Cream (NCS S 2005-Y20R)</li> <li>● <b>62/</b> __ Green (NCS S 3010-G20Y)</li> <li>● <b>93/</b> __ White (NCS S 0502-Y)</li> </ul> <p><b>Finish customization</b><br/>(Available options:<br/>Vibia colour palette)</p> | <p><b>LED temperature colour</b></p> <p>/1 _ 2700 K  <br/>CRI &gt;90 485 lm 121 lm/W</p> | <p><b>Control</b></p> <p><b>1660</b> __ / _ 0 <b>600,00 €</b><br/>On/ Off</p> |
| <p><b>Materials</b></p> <p>Head: Aluminum. Base: Zamak.<br/>Diffuser: Polycarbonate. Rod: Steel.</p> <p><b>Light Source and electronics</b></p> <p>1 x LED 4,5 W 350 mA<br/>Constant Current 350 mA<br/>100~240V 50/60Hz</p> | <p><b>Packaging</b></p> <p>1 Box 0,149 x 0,265 x 0,33 m<br/>Vol 0,1310 m<sup>3</sup><br/>Gross weight 7,45 Kg Net weight 3,8 Kg</p> <p><b>Notes</b></p> <p>Switch on the base. Electric cable 3 m.</p> <p> </p>   |  |   |



1665

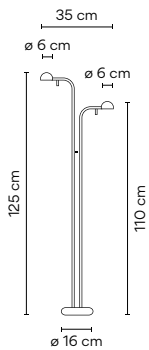

Finishes

- 04/ \_\_ Black (NCS 9000N)
- 58/ \_\_ Cream (NCS S 2005-Y20R)
- 62/ \_\_ Green (NCS S 3010-G20Y)
- 93/ \_\_ White (NCS S 0502-Y)

Finish customization  
(Available options:  
Vibia colour palette)

Materials

Head: Aluminum. Base: Zamak.  
Diffuser: Polycarbonate. Rod: Steel.

Light Source and electronics

2 x LED 4,5 W 350 mA  
Constant Current 350 mA  
100~240V 50/60Hz

LED colour temperature

/1\_ 2700 K   
CRI >90 980,5 lm 109 lm/W

Control

1665 \_\_ / \_ 0  
On/ Off

820,00 €

Packaging

1 Box 1,496 x 0,265 x 0,33 m  
Vol 0,1310 m<sup>3</sup>  
Gross weight 8,25 Kg Net weight 4,6 Kg

Notes

Switch on the base. Electric cable 3 m.

**UNTIL STOCK RUNS OUT**

1670

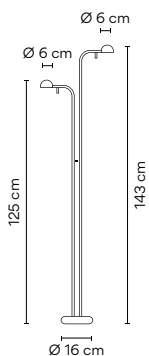

Finishes

- 04/ \_\_ Black (NCS 9000N)
- 58/ \_\_ Cream (NCS S 2005-Y20R)
- 62/ \_\_ Green (NCS S 3010-G20Y)
- 93/ \_\_ White (NCS S 0502-Y)

Finish customization  
(Available options:  
Vibia colour palette)

Materials

Head: Aluminum. Base: Zamak.  
Diffuser: Polycarbonate. Rod: Steel.

Light Source and electronics

2 x LED 4,5 W 350 mA  
Constant Current 350 mA  
100~240V 50/60Hz

LED temperature colour

/1\_ 2700 K   
CRI >90 970 lm 121 lm/W

Control

1670 \_\_ / \_ 0  
On/ Off

850,00 €

Packaging

1 Box 1,496 x 0,265 x 0,33 m  
Vol 0,1310 m<sup>3</sup>  
Gross weight 8,25 Kg Net weight 4,6 Kg

Notes

Switch on the base. Electric cable 3 m.

Wall



ø 10 cm

**1675 62**



ø 10 cm

**1675 04**



ø 10 cm

**1675 58**



ø 10 cm

**1675 93**



ø 10 cm

**1680**



ø 10 cm

**1685**



ø 10 cm

**1686**



ø 10 cm

**1690**



ø 10 cm

**1692**

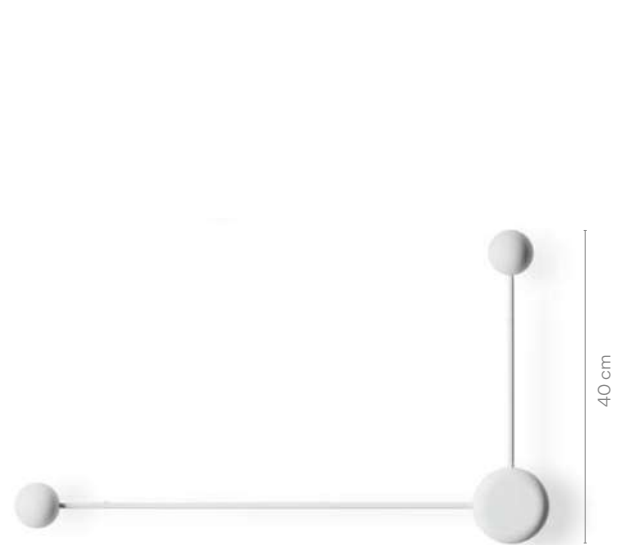

ø 10 cm

**1694**

1675

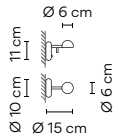

|   |  |   |                        |
|---|--|---|------------------------|
| <p><b>Finishes</b></p> <ul style="list-style-type: none"> <li>● <b>04/</b> __ Black (NCS 9000N)</li> <li>● <b>58/</b> __ Cream (NCS S 2005-Y20R)</li> <li>● <b>62/</b> __ Green (NCS S 3010-G20Y)</li> <li>● <b>93/</b> __ White (NCS S 0502-Y)</li> </ul> <p><b>Finish customization</b><br/>         (Available options:<br/>         Vibia colour palette)</p> | <p><b>LED temperature colour</b></p> <p><b>/1</b> 2700 K  <br/>         CRI &gt;90 485 lm 121 lm/W</p> | <p><b>Control</b></p> <p><b>1675</b> __ / __ 0<br/>         On/ Off</p> | <p><b>315,00 €</b></p> |
|---|--|---|------------------------|

|   |  |
|---|--|
| <p><b>Materials</b></p> <p>Head: Aluminum. Base: Zamak.<br/>         Diffuser: Polycarbonate. Rod: Steel.</p> <p><b>Light Source and electronics</b></p> <p>1 x LED 4,5 W 350 mA<br/>         Constant Current 350 mA<br/>         100~240V 50/60Hz</p> | <p><b>Packaging</b></p> <p>1 Box 0,193 x 0,148 x 0,161 m<br/>         Vol 0,0046 m<sup>3</sup><br/>         Gross weight 0,85 Kg Net weight 0,6 Kg</p> <p><b>Notes</b></p> <p>Switch on the wall plate</p> |
|---|--|



1680

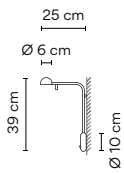

|   |  |   |                        |
|---|--|---|------------------------|
| <p><b>Finishes</b></p> <ul style="list-style-type: none"> <li>● <b>04/</b> __ Black (NCS 9000N)</li> <li>● <b>58/</b> __ Cream (NCS S 2005-Y20R)</li> <li>● <b>62/</b> __ Green (NCS S 3010-G20Y)</li> <li>● <b>93/</b> __ White (NCS S 0502-Y)</li> </ul> <p><b>Finish customization</b><br/>         (Available options:<br/>         Vibia colour palette)</p> | <p><b>LED temperature colour</b></p> <p><b>/1</b> 2700 K  <br/>         CRI &gt;90 485 lm 121 lm/W</p> | <p><b>Control</b></p> <p><b>1680</b> __ / __ 0<br/>         On/ Off</p> | <p><b>380,00 €</b></p> |
|---|--|---|------------------------|

|   |   |
|---|---|
| <p><b>Materials</b></p> <p>Head: Aluminum. Base: Zamak.<br/>         Diffuser: Polycarbonate. Rod: Steel.</p> <p><b>Light Source and electronics</b></p> <p>1 x LED 4,5 W 350 mA<br/>         Constant Current 350 mA<br/>         100~240V 50/60Hz</p> | <p><b>Packaging</b></p> <p>1 Box 0,146 x 0,355 x 0,473 m<br/>         Vol 0,0250 m<sup>3</sup><br/>         Gross weight 1,745 Kg Net weight 1 Kg</p> <p><b>Notes</b></p> <p>Switch on the wall plate</p> |
|---|---|



1685

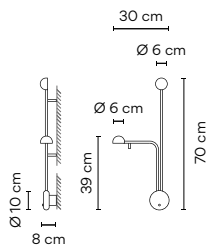

|   |  |   |                        |
|---|--|---|------------------------|
| <p><b>Finishes</b></p> <ul style="list-style-type: none"> <li>● <b>04/</b> __ Black (NCS 9000N)</li> <li>● <b>58/</b> __ Cream (NCS S 2005-Y20R)</li> <li>● <b>62/</b> __ Green (NCS S 3010-G20Y)</li> <li>● <b>93/</b> __ White (NCS S 0502-Y)</li> </ul> <p><b>Finish customization</b><br/>         (Available options:<br/>         Vibia colour palette)</p> | <p><b>LED temperature colour</b></p> <p><b>/1</b> 2700 K  <br/>         CRI &gt;90 970 lm 121 lm/W</p> | <p><b>Control</b></p> <p><b>1685</b> __ / __ 0<br/>         On/ Off</p> | <p><b>620,00 €</b></p> |
|---|--|---|------------------------|

|   |  |
|---|--|
| <p><b>Materials</b></p> <p>Head: Aluminum. Base: Zamak.<br/>         Diffuser: Polycarbonate. Rod: Steel.</p> <p><b>Light Source and electronics</b></p> <p>2 x LED 4,5 W 350 mA<br/>         Constant Current 350 mA<br/>         100~240V 50/60Hz</p> | <p><b>Packaging</b></p> <p>1 Box 0,177 x 0,445 x 0,792 m<br/>         Vol 0,0620 m<sup>3</sup><br/>         Gross weight 2,64 Kg Net weight 1,2 Kg</p> <p><b>Notes</b></p> <p>Switch on the wall plate</p> |
|---|--|



**1686**

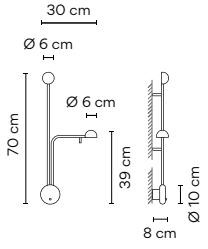

**Finishes**

- **04/** \_\_ Black (NCS 9000N)
- **58/** \_\_ Cream (NCS S 2005-Y20R)
- **62/** \_\_ Green (NCS S 3010-G20Y)
- **93/** \_\_ White (NCS S 0502-Y)

**LED temperature colour**

**/1** 2700 K  CRI >90 970 lm 121 lm/W

**Control**

**1686** \_\_ / \_\_ 0  
On/ Off

**620,00 €**





**Finish customization**  
(Available options:  
Vibia colour palette)

**Materials**  
Head: Aluminum. Base: Zamak.  
Diffuser: Polycarbonate. Rod: Steel.

**Light Source and electronics**  
2 x LED 4,5 W 350 mA  
Constant Current 350 mA  
100~240V 50/60Hz

**Packaging**  
1 Box 0,177 x 0,445 x 0,792 m  
Vol 0,0620 m<sup>3</sup>  
Gross weight 2,64 Kg Net weight 1,2 Kg

**Notes**  
Switch on the wall plate

**1690**

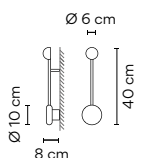

**Finishes**

- **04/** \_\_ Black (NCS 9000N)
- **58/** \_\_ Cream (NCS S 2005-Y20R)
- **62/** \_\_ Green (NCS S 3010-G20Y)
- **93/** \_\_ White (NCS S 0502-Y)

**LED temperature colour**

**/1** 2700 K  CRI >90 485 lm 121 lm/W

**Control**

**1690** \_\_ / \_\_ 0  
On/ Off





**415,00 €**

**Finish customization**  
(Available options:  
Vibia colour palette)

**Materials**  
Head: Aluminum. Base: Zamak.  
Diffuser: Polycarbonate. Rod: Steel.

**Light Source and electronics**  
1 x LED 4,5 W 350 mA  
Constant Current 350 mA  
100~240V 50/60Hz

**Packaging**  
1 Box 0,146 x 0,355 x 0,473 m  
Vol 0,0250 m<sup>3</sup>  
Gross weight 1,545 Kg Net weight 0,8 Kg

**1692**

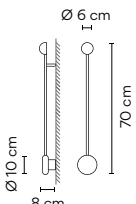

**Finishes**

- **04/** \_\_ Black (NCS 9000N)
- **58/** \_\_ Cream (NCS S 2005-Y20R)
- **62/** \_\_ Green (NCS S 3010-G20Y)
- **93/** \_\_ White (NCS S 0502-Y)

**LED temperature colour**

**/1** 2700 K  CRI >90 485 lm 121 lm/W

**Control**

**1692** \_\_ / \_\_ 0  
On/ Off





**435,00 €**

**Finish customization**  
(Available options:  
Vibia colour palette)

**Materials**  
Head: Aluminum. Base: Zamak.  
Diffuser: Polycarbonate. Rod: Steel.

**Light Source and electronics**  
1 x LED 4,5 W 350 mA  
Constant Current 350 mA  
100~240V 50/60Hz

**Packaging**  
1 Box 0,177 x 0,445 x 0,792 m  
Vol 0,620 m<sup>3</sup>  
Gross weight 2,44 Kg Net weight 1 Kg



1694

Finishes      LED temperature colour      Control

● 04/ \_\_ Black      /1\_ 2700 K       1694 \_\_ / \_ 0      600,00 €  
 (NCS 9000N)      CRI >90 970 lm 121 lm/W      On/ Off

- 58/ \_\_ Cream  
(NCS S 2005-Y20R)
- 62/ \_\_ Green  
(NCS S 3010-G20Y)
- 93/ \_\_ White  
(NCS S 0502-Y)

Finish customization  
 (Available options:  
 Vibia colour palette)

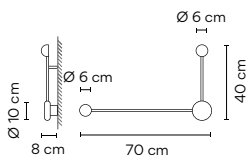

Materials  
 Head: Aluminum. Base: Zamak.  
 Diffuser: Polycarbonate. Rod: Steel.

Light Source and electronics  
 2 x LED 4,5 W 350 mA  
 Constant Current 350 mA  
 100~240V 50/60Hz

Packaging  
 1 Box 0,177 x 0,445 x 0,792 m  
 Vol 0,620 m<sup>3</sup>  
 Gross weight 2,84 Kg Net weight 1,4 Kg

# Array

Design by Umut Yamac

A striking pendant of impressive proportions, Array is an exploration of thread and its potential to create lightweight and dynamic sculptures of light.

## Pendants

Height 70 cm



Ø 37 cm

**1800**



Ø 55 cm

**1815**

Height 110 cm



Ø 37 cm

**1805**



Ø 55 cm

**1820**



Ø 83 cm

**1830**



Ø 124 cm

**1840**

Height 190 cm



Ø 37 cm

**1810**



Ø 55 cm

**1825**



Ø 83 cm

**1835**



Ø 124 cm

**1845**



---

Height 70 cm



Ø 55 cm

**1850**

Height 110 cm



Ø 55 cm

**1855**



Ø 83 cm

**1865**



Ø 124 cm

**1875**

Height 190 cm



Ø 55 cm

**1860**



Ø 83 cm

**1870**



Ø 124 cm

**1880**

1800

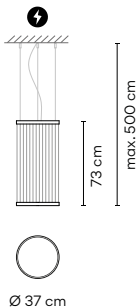

| Finishes (threads)                      | LED Colour Temperature                 | Control                        |            |
|---|--|--------------------------------|------------|
| ● 24/ _ _ Beige M1<br>(NCS S 2005-Y50R) | /1_ 2700 K<br>CRI >90 2662 lm 121 lm/W | 1800 _ _ / _ 3<br>1-10V        | 2.180,00 € |
| ● 37/ _ _ Terra Red<br>(NCS S4040-Y70R) |  | 1800 _ _ / _ D<br>Push; DALI-2 | 2.290,00 € |
| ● 47/ _ _ Green L1<br>(NCS S 4005-G80Y) |  | 1800 _ _ / _ Z<br>Casambi      | 2.300,00 € |

Finishes (rings and canopy)  
● Black (NCS S 8500-N)

Materials  
Upper ring: Aluminum. Bottom ring: Brass.  
Diffuser: PC- Polycarbonate. Threads: PES FR.

Light Source and electronics  
1 x LED STRIP 22W 48V  
Constant Voltage 48V  
90-305Vac 50/60Hz

Packaging  
1 Box 0,62 x 0,62 x 0,12 m  
Vol 0,0461 m<sup>3</sup>  
Gross weight 7 Kg Net weight 4,8 Kg

Notes  
Extra cable length. 16,00 €/m



Multi-volt Dimmer

Select Electrical connection  
Surface  
\_24 Built-in S  
\_31 Remote Micro

1805

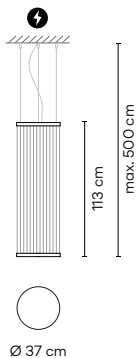

| Finishes (threads)                      | LED Colour Temperature                 | Control                        |            |
|---|--|--------------------------------|------------|
| ● 24/ _ _ Beige M1<br>(NCS S 2005-Y50R) | /1_ 2700 K<br>CRI >90 2662 lm 121 lm/W | 1805 _ _ / _ 3<br>1-10V        | 2.290,00 € |
| ● 37/ _ _ Terra Red<br>(NCS S4040-Y70R) |  | 1805 _ _ / _ D<br>Push; DALI-2 | 2.405,00 € |
| ● 47/ _ _ Green L1<br>(NCS S 4005-G80Y) |  | 1805 _ _ / _ Z<br>Casambi      | 2.410,00 € |

Finishes (rings and canopy)  
● Black (NCS S 8500-N)

Materials  
Upper ring: Aluminum. Bottom ring: Brass.  
Diffuser: PC- Polycarbonate. Threads: PES FR.

Light Source and electronics  
1 x LED STRIP 22W 48V  
Constant Voltage 48V  
90-305Vac 50/60Hz

Packaging  
1 Box 0,62 x 0,62 x 0,12 m  
Vol 0,0461 m<sup>3</sup>  
Gross weight 7,3 Kg Net weight 5,1 Kg

Notes  
Extra cable length. 16,00 €/m



Multi-volt Dimmer

Select Electrical connection  
Surface  
\_24 Built-in S  
\_31 Remote Micro

1810

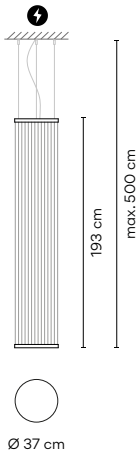

| Finishes (threads)                      | LED Colour Temperature                 | Control                        |            |
|---|--|--------------------------------|------------|
| ● 24/ _ _ Beige M1<br>(NCS S 2005-Y50R) | /1_ 2700 K<br>CRI >90 2662 lm 121 lm/W | 1810 _ _ / _ 3<br>1-10V        | 2.340,00 € |
| ● 37/ _ _ Terra Red<br>(NCS S4040-Y70R) |  | 1810 _ _ / _ D<br>Push; DALI-2 | 2.460,00 € |
| ● 47/ _ _ Green L1<br>(NCS S 4005-G80Y) |  | 1810 _ _ / _ Z<br>Casambi      | 2.460,00 € |

Finishes (rings and canopy)  
● Black (NCS S 8500-N)

Materials  
Upper ring: Aluminum. Bottom ring: Brass.  
Diffuser: PC- Polycarbonate. Threads: PES FR.

Light Source and electronics  
1 x LED STRIP 22W 48V  
Constant Voltage 48V  
90-305Vac 50/60Hz

Packaging  
1 Box 0,62 x 0,62 x 0,12 m  
Vol 0,0461 m<sup>3</sup>  
Gross weight 7,6 Kg Net weight 5,4 Kg

Notes  
Extra cable length. 16,00 €/m



Multi-volt Dimmer

Select Electrical connection  
Surface  
\_24 Built-in S  
\_31 Remote Micro

1815

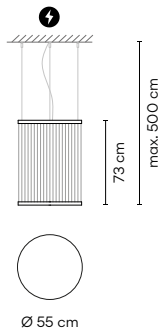

|                                       |  |
|---------------------------------------|--|
| <b>Finishes (threads)</b>             | <b>LED Colour Temperature</b>          |
| ● 24/ _ Beige M1<br>(NCS S 2005-Y50R) | /1_ 2700 K<br>CRI >90 3993 lm 121 lm/W |
| ● 37/ _ Terra Red<br>(NCS S4040-Y70R) |  |
| ● 47/ _ Green L1<br>(NCS S 4005-G80Y) |  |

|                              |            |
|------------------------------|------------|
| <b>Control</b>               |            |
| 1815 _ / _ 3<br>1-10V        | 2.560,00 € |
| 1815 _ / _ D<br>Push; DALI-2 | 2.690,00 € |
| 1815 _ / _ Z<br>Casambi      | 2.680,00 € |

|                                    |
|------------------------------------|
| <b>Finishes (rings and canopy)</b> |
| ● Black (NCS S 8500-N)             |

**Materials**  
Upper ring: Aluminum. Bottom ring: Brass.  
Diffuser: PC- Polycarbonate. Threads: PES FR.

**Light Source and electronics**  
1 x LED STRIP 33W 48V  
Constant Voltage 48V  
90~305Vac 50/60Hz

**Packaging**  
1 Box 0,62 x 0,62 x 0,12 m  
Vol 0,0461 m<sup>3</sup>  
Gross weight 8,4 Kg Net weight 6,2 Kg

**Notes**  
Extra cable length. 16,00 €/m

LED IP20 CE EAC

Multi-volt Dimmer

Select Electrical connection  
Surface  
\_24 Built-in S  
\_31 Remote Micro

1820

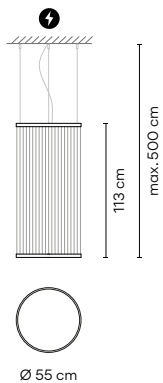

|                                       |  |
|---------------------------------------|--|
| <b>Finishes (threads)</b>             | <b>LED Colour Temperature</b>          |
| ● 24/ _ Beige M1<br>(NCS S 2005-Y50R) | /1_ 2700 K<br>CRI >90 3993 lm 121 lm/W |
| ● 37/ _ Terra Red<br>(NCS S4040-Y70R) |  |
| ● 47/ _ Green L1<br>(NCS S 4005-G80Y) |  |

|                              |            |
|------------------------------|------------|
| <b>Control</b>               |            |
| 1820 _ / _ 3<br>1-10V        | 2.755,00 € |
| 1820 _ / _ D<br>Push; DALI-2 | 2.895,00 € |
| 1820 _ / _ Z<br>Casambi      | 2.875,00 € |

|                                    |
|------------------------------------|
| <b>Finishes (rings and canopy)</b> |
| ● Black (NCS S 8500-N)             |

**Materials**  
Upper ring: Aluminum. Bottom ring: Brass.  
Diffuser: PC- Polycarbonate. Threads: PES FR.

**Light Source and electronics**  
1 x LED STRIP 33W 48V  
Constant Voltage 48V  
90~305Vac 50/60Hz

**Packaging**  
1 Box 0,62 x 0,62 x 0,12 m  
Vol 0,0461 m<sup>3</sup>  
Gross weight 8,8 Kg Net weight 6,6 Kg

**Notes**  
Extra cable length. 16,00 €/m

LED IP20 CE EAC

Multi-volt Dimmer

Select Electrical connection  
Surface  
\_24 Built-in S  
\_31 Remote Micro

1825

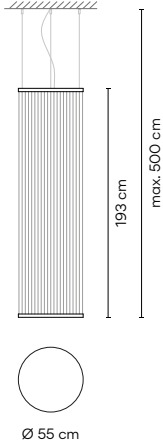

|                                       |  |
|---------------------------------------|--|
| <b>Finishes (threads)</b>             | <b>LED Colour Temperature</b>          |
| ● 24/ _ Beige M1<br>(NCS S 2005-Y50R) | /1_ 2700 K<br>CRI >90 3993 lm 121 lm/W |
| ● 37/ _ Terra Red<br>(NCS S4040-Y70R) |  |
| ● 47/ _ Green L1<br>(NCS S 4005-G80Y) |  |

|                              |            |
|------------------------------|------------|
| <b>Control</b>               |            |
| 1825 _ / _ 3<br>1-10V        | 2.825,00 € |
| 1825 _ / _ D<br>Push; DALI-2 | 2.970,00 € |
| 1825 _ / _ Z<br>Casambi      | 2.945,00 € |

|                                    |
|------------------------------------|
| <b>Finishes (rings and canopy)</b> |
| ● Black (NCS S 8500-N)             |

**Materials**  
Upper ring: Aluminum. Bottom ring: Brass.  
Diffuser: PC- Polycarbonate. Threads: PES FR.

**Light Source and electronics**  
1 x LED STRIP 33W 48V  
Constant Voltage 48V  
90~305Vac 50/60Hz

**Packaging**  
1 Box 0,62 x 0,62 x 0,12 m  
Vol 0,0461 m<sup>3</sup>  
Gross weight 9,2 Kg Net weight 7 Kg

**Notes**  
Extra cable length. 16,00 €/m

LED IP20 CE EAC

Multi-volt Dimmer

Select Electrical connection  
Surface  
\_24 Built-in S  
\_31 Remote Micro

**1830**

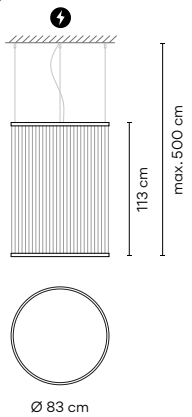

**Finishes (threads)**

- 24/ \_ \_ Beige M1 (NCS S 2005-Y50R)
- 37/ \_ \_ Terra Red (NCS S4040-Y70R)
- 47/ \_ \_ Green L1 (NCS S 4005-G80Y)

**LED Colour Temperature**

/1\_ 2700 K  CRI >90 6050 lm 121 lm/W

**Control**

|                                |            |
|--------------------------------|------------|
| 1830 _ _ / _ 3<br>1-10V        | 3.575,00 € |
| 1830 _ _ / _ D<br>Push; DALI-2 | 3.755,00 € |
| 1830 _ _ / _ Z<br>Casambi      | 3.695,00 € |

**Finishes (rings and canopy)**

- Black (NCS S 8500-N)

**Materials**

Upper ring: Aluminum. Bottom ring: Brass.  
Diffuser: PC- Polycarbonate. Threads: PES FR.

**Light Source and electronics**





1 x LED STRIP 50W 48V  
Constant Voltage 48V  
90~305Vac 50/60Hz

**Packaging**

1 Box 0,93 x 0,93 x 0,120 m  
Vol 0,1037 m<sup>3</sup>  
Gross weight 13,5 Kg Net weight 9,5 Kg

**Notes**

Extra cable length. 16,00 €/m

    

**Multi-volt** **Dimmer**

 Select Electrical connection

- Surface
- \_24 Built-in S
- \_31 Remote Micro

**1835**

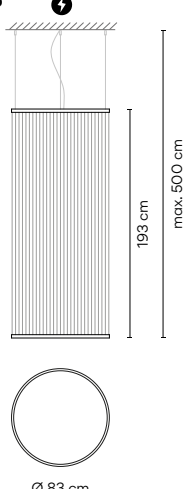

**Finishes (threads)**

- 24/ \_ \_ Beige M1 (NCS S 2005-Y50R)
- 37/ \_ \_ Terra Red (NCS S4040-Y70R)
- 47/ \_ \_ Green L1 (NCS S 4005-G80Y)

**LED Colour Temperature**

/1\_ 2700 K  CRI >90 6050 lm 121 lm/W

**Control**

|                                |            |
|--------------------------------|------------|
| 1835 _ _ / _ 3<br>1-10V        | 3.665,00 € |
| 1835 _ _ / _ D<br>Push; DALI-2 | 3.850,00 € |
| 1835 _ _ / _ Z<br>Casambi      | 3.785,00 € |

**Finishes (rings and canopy)**

- Black (NCS S 8500-N)

**Materials**

Upper ring: Aluminum. Bottom ring: Brass.  
Diffuser: PC- Polycarbonate. Threads: PES FR.

**Light Source and electronics**





1 x LED STRIP 50W 48V  
Constant Voltage 48V  
90~305Vac 50/60Hz

**Packaging**

1 Box 0,93 x 0,93 x 0,120 m  
Vol 0,1037 m<sup>3</sup>  
Gross weight 14,1 Kg Net weight 10,1 Kg

**Notes**

Extra cable length. 16,00 €/m

    

**Multi-volt** **Dimmer**

 Select Electrical connection

- Surface
- \_24 Built-in S
- \_31 Remote Micro

**1840**

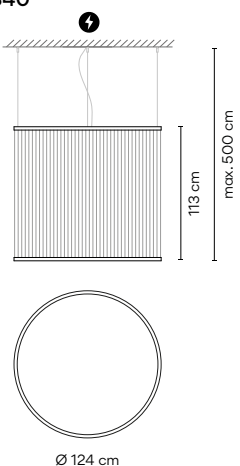

**Finishes (threads)**

- 24/ \_ \_ Beige M1 (NCS S 2005-Y50R)
- 37/ \_ \_ Terra Red (NCS S4040-Y70R)
- 47/ \_ \_ Green L1 (NCS S 4005-G80Y)

**LED Colour Temperature**

/1\_ 2700 K  CRI >90 9196 lm 121 lm/W

**Control**

|                                |            |
|--------------------------------|------------|
| 1840 _ _ / _ 3<br>1-10V        | 4.985,00 € |
| 1840 _ _ / _ D<br>Push; DALI-2 | 5.235,00 € |
| 1840 _ _ / _ Z<br>Casambi      | 5.105,00 € |

**Finishes (rings and canopy)**

- Black (NCS S 8500-N)

**Materials**

Upper ring: Aluminum. Bottom ring: Brass.  
Diffuser: PC- Polycarbonate. Threads: PES FR.

**Light Source and electronics**





1 x LED STRIP 76W 48V  
Constant Voltage 48V  
90~305Vac 50/60Hz

**Packaging**

1 Box 1,35 x 1,35 x 0,120 m  
Vol 0,2187 m<sup>3</sup>  
Gross weight 19 Kg Net weight 13 Kg

**Notes**

Extra cable length. 16,00 €/m

**Multi-volt** **Dimmer**

 Select Electrical connection

- Surface
- \_24 Built-in S
- \_31 Remote Micro

1160 | 10 | /1A | 18

Model | Finish | LED Colour Temperature | Control | Electrical connection

1845

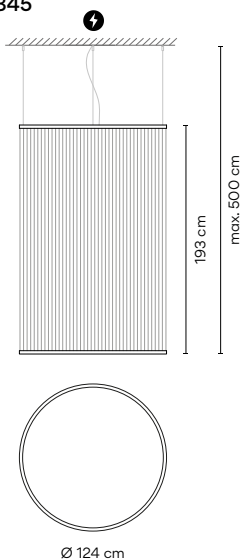

| Finishes (threads)                      | LED Colour Temperature                 |
|---|--|
| ● 24/ _ _ Beige M1<br>(NCS S 2005-Y50R) | /1_ 2700 K<br>CRI >90 9196 lm 121 lm/W |
| ● 37/ _ _ Terra Red<br>(NCS S4040-Y70R) |  |
| ● 47/ _ _ Green L1<br>(NCS S 4005-G80Y) |  |

| Control                        |            |
|--------------------------------|------------|
| 1845 _ _ / _ 3<br>1-10V        | 5.145,00 € |
| 1845 _ _ / _ D<br>Push; DALI-2 | 5.405,00 € |
| 1845 _ _ / _ Z<br>Casambi      | 5.265,00 € |

Select Electrical connection  
Surface  
\_24 Built-in S  
\_31 Remote  
Micro

| Finishes (rings and canopy) |
|-----------------------------|
| ● Black (NCS S 8500-N)      |

**Materials**

Upper ring: Aluminum. Bottom ring: Brass.  
Diffuser: PC- Polycarbonate. Threads: PES FR.

**Light Source and electronics**

1 x LED STRIP 76W 48V  
Constant Voltage 48V  
90~305Vac 50/60Hz

**Packaging**

1 Box 1,35 x 1,35 x 0,120 m  
Vol 0,2187 m<sup>3</sup>  
Gross weight 19,9 Kg Net weight 13,9 Kg

**Notes**

Extra cable length. 16,00 €/m

LED IP20 CE EAC

Multi-volt Dimmer



1850

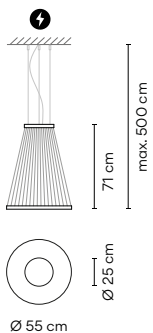

| Finishes (threads)                      | LED Colour Temperature                 | Control                        |            |
|---|--|--------------------------------|------------|
| ● 24/ _ _ Beige M1<br>(NCS S 2005-Y50R) | /1_ 2700 K<br>CRI >90 3993 lm 121 lm/W | 1850 _ _ / _ 3<br>1-10V        | 2.395,00 € |
| ● 37/ _ _ Terra Red<br>(NCS S4040-Y70R) |  | 1850 _ _ / _ D<br>Push; DALI-2 | 2.515,00 € |
| ● 47/ _ _ Green L1<br>(NCS S 4005-G80Y) |  | 1850 _ _ / _ Z<br>Casambi      | 2.515,00 € |

Finishes (rings and canopy)  
● Black (NCS S 8500-N)

Materials  
Upper ring: Aluminum. Bottom ring: Brass.  
Diffuser: PC- Polycarbonate. Threads: PES FR.

Light Source and electronics  
1 x LED STRIP 33W 48V  
Constant Voltage 48V  
90-305Vac 50/60Hz

Packaging  
1 Box 0,62 x 0,62 x 0,121 m  
Vol 0,0461 m<sup>3</sup>  
Gross weight 7,9 Kg Net weight 5,7 Kg

Notes  
Extra cable length. 16,00 €/m



Multi-volt Dimmer

Select Electrical connection  
Surface  
\_24 Built-in S  
\_31 Remote Micro

1855

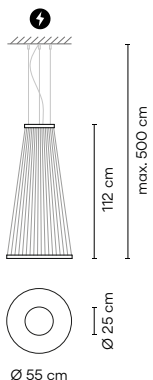

| Finishes (threads)                      | LED Colour Temperature                 | Control                        |            |
|---|--|--------------------------------|------------|
| ● 24/ _ _ Beige M1<br>(NCS S 2005-Y50R) | /1_ 2700 K<br>CRI >90 3993 lm 121 lm/W | 1855 _ _ / _ 3<br>1-10V        | 2.580,00 € |
| ● 37/ _ _ Terra Red<br>(NCS S4040-Y70R) |  | 1855 _ _ / _ D<br>Push; DALI-2 | 2.710,00 € |
| ● 47/ _ _ Green L1<br>(NCS S 4005-G80Y) |  | 1855 _ _ / _ Z<br>Casambi      | 2.700,00 € |

Finishes (rings and canopy)  
● Black (NCS S 8500-N)

Materials  
Upper ring: Aluminum. Bottom ring: Brass.  
Diffuser: PC- Polycarbonate. Threads: PES FR.

Light Source and electronics  
1 x LED STRIP 33W 48V  
Constant Voltage 48V  
90-305Vac 50/60Hz

Packaging  
1 Box 0,62 x 0,62 x 0,121 m  
Vol 0,0461 m<sup>3</sup>  
Gross weight 8,3 Kg Net weight 6,1 Kg

Notes  
Extra cable length. 16,00 €/m



Multi-volt Dimmer

Select Electrical connection  
Surface  
\_24 Built-in S  
\_31 Remote Micro

1860

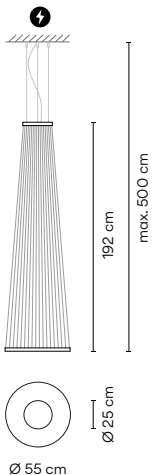

| Finishes (threads)                      | LED Colour Temperature                 | Control                        |            |
|---|--|--------------------------------|------------|
| ● 24/ _ _ Beige M1<br>(NCS S 2005-Y50R) | /1_ 2700 K<br>CRI >90 3993 lm 121 lm/W | 1860 _ _ / _ 3<br>1-10V        | 2.685,00 € |
| ● 37/ _ _ Terra Red<br>(NCS S4040-Y70R) |  | 1860 _ _ / _ D<br>Push; DALI-2 | 2.820,00 € |
| ● 47/ _ _ Green L1<br>(NCS S 4005-G80Y) |  | 1860 _ _ / _ Z<br>Casambi      | 2.805,00 € |

Finishes (rings and canopy)  
● Black (NCS S 8500-N)

Materials  
Upper ring: Aluminum. Bottom ring: Brass.  
Diffuser: PC- Polycarbonate. Threads: PES FR.

Light Source and electronics  
1 x LED STRIP 33W 48V  
Constant Voltage 48V  
90-305Vac 50/60Hz

Packaging  
1 Box 0,62 x 0,62 x 0,121 m  
Vol 0,0461 m<sup>3</sup>  
Gross weight 8,7 Kg Net weight 6,5 Kg

Notes  
Extra cable length. 16,00 €/m



Multi-volt Dimmer

Select Electrical connection  
Surface  
\_24 Built-in S  
\_31 Remote Micro

1865

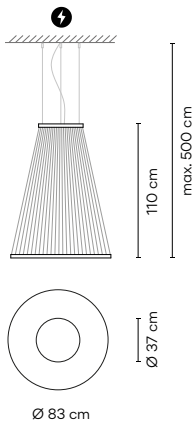

|                                       |  |                              |
|---------------------------------------|--|------------------------------|
| <b>Finishes (threads)</b>             | <b>LED Colour Temperature</b>          | <b>Control</b>               |
| ● 24/ _ Beige M1<br>(NCS S 2005-Y50R) | /1_ 2700 K<br>CRI >90 6050 lm 121 lm/W | 1865 _ / _ 3<br>1-10V        |
| ● 37/ _ Terra Red<br>(NCS S4040-Y70R) |  | 1865 _ / _ D<br>Push; DALI-2 |
| ● 47/ _ Green L1<br>(NCS S 4005-G80Y) |  | 1865 _ / _ Z<br>Casambi      |

**Finishes (rings and canopy)**  
● Black (NCS S 8500-N)

**Materials**  
Upper ring: Aluminum. Bottom ring: Brass.  
Diffuser: PC- Polycarbonate. Threads: PES FR.

**Light Source and electronics**  
1 x LED STRIP 50W 48V  
Constant Voltage 48V  
90-305Vac 50/60Hz

**Packaging**  
1 Box 0,93 x 0,93 x 0,120 m  
Vol 0,1037 m<sup>3</sup>  
Gross weight 11,8 Kg Net weight 8,8 Kg

**Notes**  
Extra cable length. 16,00 €/m



Multi-volt Dimmer

Select Electrical connection  
Surface  
\_24 Built-in S  
\_31 Remote Micro

1870

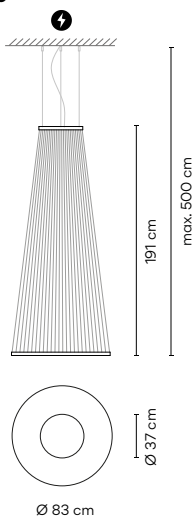

|                                       |  |                              |
|---------------------------------------|--|------------------------------|
| <b>Finishes (threads)</b>             | <b>LED Colour Temperature</b>          | <b>Control</b>               |
| ● 24/ _ Beige M1<br>(NCS S 2005-Y50R) | /1_ 2700 K<br>CRI >90 6050 lm 121 lm/W | 1870 _ / _ 3<br>1-10V        |
| ● 37/ _ Terra Red<br>(NCS S4040-Y70R) |  | 1870 _ / _ D<br>Push; DALI-2 |
| ● 47/ _ Green L1<br>(NCS S 4005-G80Y) |  | 1870 _ / _ Z<br>Casambi      |

**Finishes (rings and canopy)**  
● Black (NCS S 8500-N)

**Materials**  
Upper ring: Aluminum. Bottom ring: Brass.  
Diffuser: PC- Polycarbonate. Threads: PES FR.

**Light Source and electronics**  
1 x LED STRIP 50W 48V  
Constant Voltage 48V  
90-305Vac 50/60Hz

**Packaging**  
1 Box 0,93 x 0,93 x 0,120 m  
Vol 0,1037 m<sup>3</sup>  
Gross weight 12,4 Kg Net weight 9,4 Kg

**Notes**  
Extra cable length. 16,00 €/m



Multi-volt Dimmer

Select Electrical connection  
Surface  
\_24 Built-in S  
\_31 Remote Micro

1875

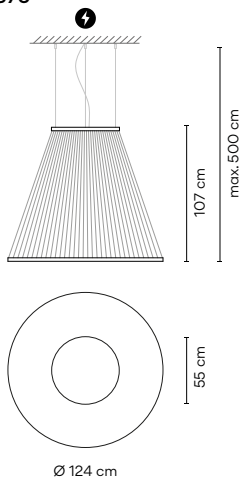

|                                       |  |                              |
|---------------------------------------|--|------------------------------|
| <b>Finishes (threads)</b>             | <b>LED Colour Temperature</b>          | <b>Control</b>               |
| ● 24/ _ Beige M1<br>(NCS S 2005-Y50R) | /1_ 2700 K<br>CRI >90 9196 lm 121 lm/W | 1875 _ / _ 3<br>1-10V        |
| ● 37/ _ Terra Red<br>(NCS S4040-Y70R) |  | 1875 _ / _ D<br>Push; DALI-2 |
| ● 47/ _ Green L1<br>(NCS S 4005-G80Y) |  | 1875 _ / _ Z<br>Casambi      |

**Finishes (rings and canopy)**  
● Black (NCS S 8500-N)

**Materials**  
Upper ring: Aluminum. Bottom ring: Brass.  
Diffuser: PC- Polycarbonate. Threads: PES FR.

**Light Source and electronics**  
1 x LED STRIP 76W 48V  
Constant Voltage 48V  
90-305Vac 50/60Hz

**Packaging**  
1 Box 1,35 x 1,35 x 0,12 m  
Vol 0,2187 m<sup>3</sup>  
Gross weight 15,9 Kg Net weight 11,9 Kg

**Notes**  
Extra cable length. 16,00 €/m



Multi-volt Dimmer

Select Electrical connection  
Surface  
\_24 Built-in S  
\_31 Remote Micro

1880

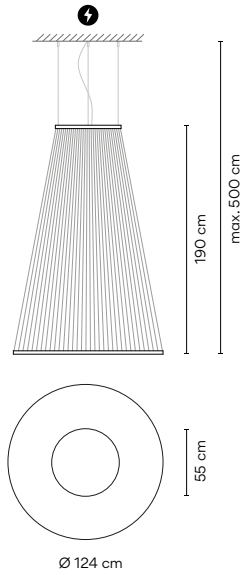

|  |                               |                       |                   |
|--|-------------------------------|-----------------------|-------------------|
| <b>Finishes (threads)</b>                      | <b>LED Colour Temperature</b> | <b>Control</b>        |                   |
| ● <b>24/ _ _ Beige M1</b><br>(NCS S 2005-Y50R) | <b>/1_ 2700 K</b>             | <b>1880 _ _ / _ 3</b> | <b>4.810,00 €</b> |
| ● <b>37/ _ _ Terra Red</b><br>(NCS S4040-Y70R) | CRI >90 9196 lm 121lm/W       | 1-10V                 |                   |
| ● <b>47/ _ _ Green L1</b><br>(NCS S 4005-G80Y) |                               | <b>1880 _ _ / _ D</b> | <b>5.055,00 €</b> |
|  |                               | Push; DALI-2          |                   |
|  |                               | <b>1880 _ _ / _ Z</b> | <b>4.930,00 €</b> |
|  |                               | Casambi               |                   |

**Finishes (rings and canopy)**  
● **Black** (NCS S 8500-N)

**Materials**  
Upper ring: Aluminum. Bottom ring: Brass.  
Diffuser: PC- Polycarbonate. Threads: PES FR.

**Light Source and electronics**  
1 x LED STRIP 76W 48V  
Constant Voltage 48V  
90-305Vac 50/60Hz

**Packaging**  
1 Box 1,35 x 1,35 x 0,12 m  
Vol 0,2187 m<sup>3</sup>  
Gross weight 16,8 Kg Net weight 12,8 Kg

**Notes**  
Extra cable length. **16,00 €/m**



**Select Electrical connection**

- Surface
- \_24 Built-in S**
- \_31 Remote Micro**
- Micro

## Electrical connection options

Choose your preferred installation option according to your needs.

### Drop ceiling

### Regular ceiling

#### **\_31 Remote Micro**



Ø 3 cm  
height 7 cm  
for plaster ceilings.  
Black finish.

#### **\_24 Built-in S**



Ø 8 cm  
height 6 cm  
black finish.

#### **Surface**



Ø 25,5 cm  
height 4,5 cm  
black finish.



Ø 37,5 cm  
height 4,5 cm  
black finish.







# Funnel

A fluid design defines this ceiling fixture, a streamlined, funnel-shaped base that flows into a protruding cap. The smooth, sculptural curves conceal a light source behind the tip, which reflects back on the funnel form and creates a flood of ambient illumination.

## Ceiling Wall

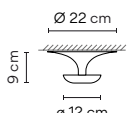
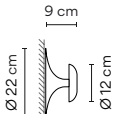

|   |   |  |   |                 |
|---|---|--|---|-----------------|
| <b>2012</b><br><br> | <b>Finishes</b><br><ul style="list-style-type: none"> <li>● <b>10/</b> _ _ White (NCS S 0300-N)</li> <li>● <b>36/</b> _ _ Soft Pink (NCS S 1010-Y50R)</li> <li>● <b>47/</b> _ _ Green L1 (NCS S 4005-G80Y)</li> </ul> | <b>LED temperature colour</b><br><ul style="list-style-type: none"> <li>/1 _ 2700 K <b>E</b> &gt;80 631,7 lm 100 lm/W</li> <li>/2 _ 3000 K <b>E</b> &gt;80 649 lm 103 lm/W</li> <li>/3 _ 3500 K <b>F</b> &gt;90 655,4 lm 104 lm/W</li> </ul> | <b>Control</b><br><b>2012</b> _ _ / _ <b>0</b><br>On/ Off | <b>385,00 €</b> |
|   | <b>Finishes</b><br><ul style="list-style-type: none"> <li>● <b>51/</b> _ _ Gold leaf (Gold leaf)</li> </ul>   | <b>LED temperature colour</b><br><ul style="list-style-type: none"> <li>/1 _ 2700 K <b>E</b> &gt;80 631,7 lm 100 lm/W</li> <li>/2 _ 3000 K <b>E</b> &gt;80 649 lm 103 lm/W</li> <li>/3 _ 3500 K <b>F</b> &gt;90 655,4 lm 104 lm/W</li> </ul> | <b>Control</b><br><b>2012</b> _ _ / _ <b>0</b><br>On/ Off | <b>535,00 €</b> |
| <b>Materials</b><br>Shade: Aluminum. Reflector: Aluminum.<br>Support: Steel.  |   | <b>Packaging</b><br>1 Box 0,27 x 0,27 x 0,16 m<br>Vol 0,0116 m <sup>3</sup><br>Gross weight 0,892 Kg Net weight 0,45 Kg  |   |                 |
| <b>Light Source and electronics</b><br>1 x LED PLATE 6,3 W 350 mA<br>Constant Current 350 mA<br>100~240V 50/60Hz  |   |    |   |                 |



### 2013

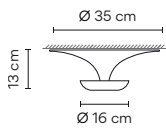

#### Finishes

- 10/ \_\_ White (NCS S 0300-N)
- 36/ \_\_ Soft Pink (NCS S 1010-Y50R)
- 47/ \_\_ Green L1 (NCS S 4005-G80Y)

#### LED temperature colour

- /1 \_ 2700 K CRI >80 2910 lm 121 lm/W
- /2 \_ 3000 K CRI >90 2910 lm 121 lm/W
- /3 \_ 3500 K CRI >90 3019,2 lm 125,8 lm/W

#### Control

2013 \_\_ / \_ A  
 DALI-2, 1-10V, Push

465,00 €

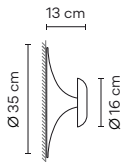

#### Finishes

- 51/ \_\_ Gold leaf (Gold leaf)

#### LED temperature colour

- /1 \_ 2700 K CRI >80 2910 lm 121 lm/W
- /2 \_ 3000 K CRI >90 2910 lm 121 lm/W
- /3 \_ 3500 K CRI >90 3019,2 lm 125,8 lm/W

#### Control

2013 \_\_ / \_ A  
 DALI-2, 1-10V, Push

650,00 €

#### Materials

Shade: Aluminum. Reflector: Aluminum.  
 Support: Steel.

#### Light Source and electronics

6 x LED 4,5 W 350 mA  
 Constant Current 350 mA  
 110-240V 50/60Hz

#### Packaging

1 Box 0,25 x 0,42 x 0,42 m  
 Vol 0,0441 m<sup>3</sup>  
 Gross weight 2,53 Kg Net weight 2 Kg

### 2014

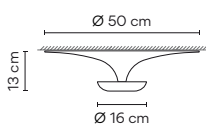

#### Finishes

- 10/ \_\_ White (NCS S 0300-N)
- 36/ \_\_ Soft Pink (NCS S 1010-Y50R)
- 47/ \_\_ Green L1 (NCS S 4005-G80Y)

#### LED temperature colour

- /1 \_ 2700 K CRI >80 2910 lm 121 lm/W
- /2 \_ 3000 K CRI >90 2910 lm 121 lm/W
- /3 \_ 3500 K CRI >90 3019,2 lm 125,8 lm/W

#### Control

2014 \_\_ / \_ A  
 DALI-2, 1-10V, Push

545,00 €

2014 \_\_ / \_ Z  
 Casambi

665,00 €

#### Materials

Shade: Aluminum. Reflector: Aluminum.  
 Support: Steel.

#### Light Source and electronics

6 x LED 4,5 W 350 mA  
 Constant Current 350 mA  
 110-240V 50/60Hz

#### Packaging

1 Box 0,27 x 0,60 x 0,60 m  
 Vol 0,0972 m<sup>3</sup>  
 Gross weight 3,782 Kg Net weight 3,3 Kg

# Rhythm Horizontal

Design by Arik Levy

Evoking the mood of Zen minimalism, Rhythm features slender light modules of varying lengths, each fitted with an LED module, that can be arranged in endless configurations. Fluid and flowing or angular and anarchic, Rhythm represents the ultimate in customised lighting.

## Pendants

2110



45 x 47 cm

2120



93 x 47 cm

2111

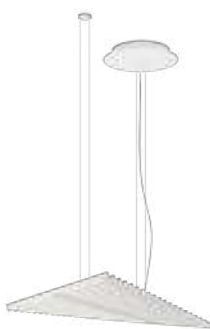

93 x 47 cm

2112



141 x 47 cm

2113



189 x 47 cm

2121



131 x 87 cm

2122



199 x 87 cm

Each project is unique.  
 Personalise your own  
 Rhythm composition  
 quick and easy.

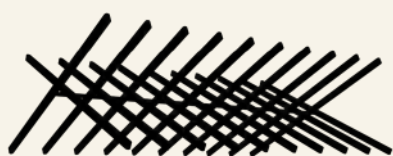

2110

- Finishes**
- 14/ \_\_ Chocolate (RAL 8019)
  - 58/ \_\_ Off-white (RAL D2-1109005)

- LED temperature colour**
- /1 \_ 2700 K CRI >90 4332 lm 144 lm/W
  - /3 \_ 3500 K CRI >90 4578,7 lm 152,6 lm/W

**Control**

|                       |            |
|-----------------------|------------|
| 2110 __ / _ 1 DALI    | 1.495,00 € |
| 2110 __ / _ 3 1-10V   | 1.420,00 € |
| 2110 __ / _ Z Casambi | 1.540,00 € |

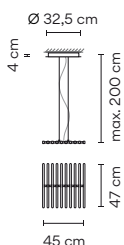

**Materials**

Stick: Polyamide 6 with 10% of Fiberglass.  
 Diffuser: Polycarbonate. Canopy: Steel.

**Light Source and electronics**  
 10 x LED STRIP 30V 2,9 W  
 Constant Voltage 30V  
 100-240V 50/60Hz

**Packaging**

2 Boxes  
 Total Vol 0,0591 m<sup>3</sup>  
 Gross weight 7,7 Kg Net weight 6 Kg

**Notes**

|  |          |
|--|----------|
| 2110-14 Built-in accessory (96 mm) chocolate | 125,00 € |
| 2110-58 Built-in accessory (96 mm) off-white | 125,00 € |

Surface and built-in fitting



## 2111

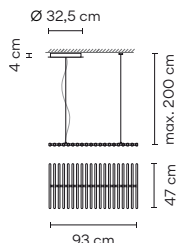

|  |  |
|--|--|
| <b>Finishes</b>                            | <b>LED temperature colour</b>                    |
| ● <b>14/</b> __ Chocolate (RAL 8019)       | <b>/1</b> _ 2700 K  CRI >90 8664 lm 144 lm/W     |
| ● <b>58/</b> __ Off-white (RAL D2-1109005) | <b>/3</b> _ 3500 K  CRI >90 9157,3 lm 152,6 lm/W |

|                                      |                   |
|--------------------------------------|-------------------|
| <b>Control</b>                       |                   |
| <b>2111</b> __ / <b>1</b><br>DALI    | <b>2.650,00 €</b> |
| <b>2111</b> __ / <b>3</b><br>1-10V   | <b>2.520,00 €</b> |
| <b>2111</b> __ / <b>Z</b><br>Casambi | <b>2.640,00 €</b> |

### Materials

Stick: Polyamide 6 with 10% of Fiberglass.  
Diffuser: Polycarbonate. Canopy: Steel.

### Light Source and electronics

20 x LED STRIP 30V 2,9 W  
Constant Voltage 30V  
100~240V 50/60Hz

### Packaging

2 Boxes  
Total Vol 0,1570 m<sup>3</sup>  
Gross weight 14,2 Kg Net weight 10,5 Kg

### Notes

|   |                 |
|---|-----------------|
| <b>2111-14</b> Built-in accessory (96 mm) chocolate | <b>125,00 €</b> |
| <b>2111-58</b> Built-in accessory (96 mm) off-white | <b>125,00 €</b> |

### Surface and built-in fitting



## 2112

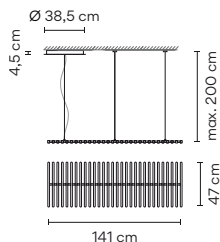

|  |   |
|--|---|
| <b>Finishes</b>                            | <b>LED temperature colour</b>                   |
| ● <b>14/</b> __ Chocolate (RAL 8019)       | <b>/1</b> _ 2700 K  CRI >90 12996 lm 144 lm/W   |
| ● <b>58/</b> __ Off-white (RAL D2-1109005) | <b>/3</b> _ 3500 K  CRI >90 13736 lm 152,6 lm/W |

|                                      |                   |
|--------------------------------------|-------------------|
| <b>Control</b>                       |                   |
| <b>2112</b> __ / <b>1</b><br>DALI    | <b>3.940,00 €</b> |
| <b>2112</b> __ / <b>3</b><br>1-10V   | <b>3.750,00 €</b> |
| <b>2112</b> __ / <b>Z</b><br>Casambi | <b>3.870,00 €</b> |

### Materials

Stick: Polyamide 6 with 10% of Fiberglass.  
Diffuser: Polycarbonate. Canopy: Steel.

### Light Source and electronics

30 x LED STRIP 30V 2,9 W  
Constant Voltage 30V  
100~240V 50/60Hz

### Packaging

2 Boxes  
Total Vol 0,0430 m<sup>3</sup>  
Gross weight 10,3 Kg Net weight 7 Kg

### Notes

|   |                 |
|---|-----------------|
| <b>2112-14</b> Built-in accessory (44,5 mm) chocolate | <b>125,00 €</b> |
| <b>2112-58</b> Built-in accessory (44,5 mm) off-white | <b>125,00 €</b> |

### Surface and built-in fitting



## 2113

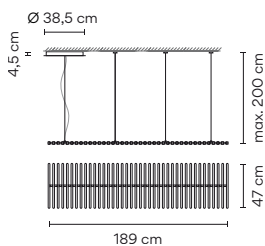

|  |   |
|--|---|
| <b>Finishes</b>                            | <b>LED temperature colour</b>                     |
| ● <b>14/</b> __ Chocolate (RAL 8019)       | <b>/1</b> _ 2700 K  CRI >90 17328 lm 144 lm/W     |
| ● <b>58/</b> __ Off-white (RAL D2-1109005) | <b>/3</b> _ 3500 K  CRI >90 18314,6 lm 152,6 lm/W |

|                                      |                   |
|--------------------------------------|-------------------|
| <b>Control</b>                       |                   |
| <b>2113</b> __ / <b>1</b><br>DALI    | <b>4.760,00 €</b> |
| <b>2113</b> __ / <b>3</b><br>1-10V   | <b>4.530,00 €</b> |
| <b>2113</b> __ / <b>Z</b><br>Casambi | <b>4.650,00 €</b> |

### Materials

Stick: Polyamide 6 with 10% of Fiberglass.  
Diffuser: Polycarbonate. Canopy: Steel.

### Light Source and electronics

40 x LED STRIP 30V 2,9 W  
Constant Voltage 30V  
100~240V 50/60Hz

### Packaging

2 Boxes  
Total Vol 0,1900 m<sup>3</sup>  
Gross weight 17,2 Kg Net weight 13,5 Kg

### Notes

|   |                 |
|---|-----------------|
| <b>2113-14</b> Built-in accessory (44,5 mm) chocolate | <b>125,00 €</b> |
| <b>2113-58</b> Built-in accessory (44,5 mm) off-white | <b>125,00 €</b> |

### Surface and built-in fitting



2120

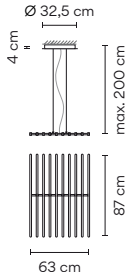

|                                     |   |
|-------------------------------------|---|
| <b>Finishes</b>                     | <b>LED temperature colour</b>             |
| ● 14/ __ Chocolate (RAL 8019)       | /1 _ 2700 K  CRI >90 7602,4 lm 127 lm/W   |
| ● 58/ __ Off-white (RAL D2-1109005) | /3 _ 3500 K  CRI >90 8035,3 lm 133,9 lm/W |

|                       |            |
|-----------------------|------------|
| <b>Control</b>        |            |
| 2120 __ / _ 1 DALI    | 1.975,00 € |
| 2120 __ / _ 3 1-10V   | 1.880,00 € |
| 2120 __ / _ Z Casambi | 2.000,00 € |

**Materials**

Stick: Polyamide 6 with 10% of Fiberglass.  
 Diffuser: Polycarbonate. Canopy: Steel.

**Light Source and electronics**

10 x LED STRIP 30V 5,8 W  
 Constant Voltage 30V  
 100~240V 50/60Hz

**Packaging**

2 Boxes  
 Total Vol 0,1380 m<sup>3</sup>  
 Gross weight 9,5 Kg Net weight 7,3 Kg

**Notes**

|   |          |
|---|----------|
| 2120-14 Built-in accessory (136 mm) chocolate | 125,00 € |
| 2120-58 Built-in accessory (136 mm) off-white | 125,00 € |

**Surface and built-in fitting**

Ø 18,5 cm Only for built-in.

2121

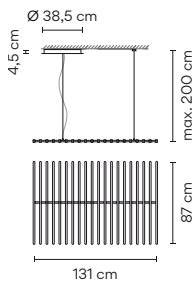

|                                     |  |
|-------------------------------------|--|
| <b>Finishes</b>                     | <b>LED temperature colour</b>              |
| ● 14/ __ Chocolate (RAL 8019)       | /1 _ 2700 K  CRI >90 15204,8 lm 127 lm/W   |
| ● 58/ __ Off-white (RAL D2-1109005) | /3 _ 3500 K  CRI >90 16070,6 lm 133,9 lm/W |

|                       |            |
|-----------------------|------------|
| <b>Control</b>        |            |
| 2121 __ / _ 1 DALI    | 3.500,00 € |
| 2121 __ / _ 3 1-10V   | 3.330,00 € |
| 2121 __ / _ Z Casambi | 3.450,00 € |

**Materials**

Stick: Polyamide 6 with 10% of Fiberglass.  
 Diffuser: Polycarbonate. Canopy: Steel.

**Light Source and electronics**

20 x LED STRIP 30V 5,8 W  
 Constant Voltage 30V  
 100~240V 50/60Hz

**Packaging**

2 Boxes  
 Total Vol 0,1664 m<sup>3</sup>  
 Gross weight 14,7 Kg Net weight 10,5 Kg

**Notes**

|  |          |
|--|----------|
| 2121-14 Built-in accessory (44,5 mm) chocolate | 125,00 € |
| 2121-58 Built-in accessory (44,5 mm) off-white | 125,00 € |

**Surface and built-in fitting**

Ø 18,5 cm Only for built-in.

2122

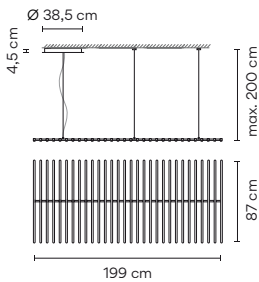

|                                     |  |
|-------------------------------------|--|
| <b>Finishes</b>                     | <b>LED temperature colour</b>              |
| ● 14/ __ Chocolate (RAL 8019)       | /1 _ 2700 K  CRI >90 22807,2 lm 127 lm/W   |
| ● 58/ __ Off-white (RAL D2-1109005) | /3 _ 3500 K  CRI >90 24105,8 lm 133,9 lm/W |

|                       |            |
|-----------------------|------------|
| <b>Control</b>        |            |
| 2122 __ / _ 1 DALI    | 4.860,00 € |
| 2122 __ / _ 3 1-10V   | 4.625,00 € |
| 2122 __ / _ Z Casambi | 4.745,00 € |

**Materials**

Stick: Polyamide 6 with 10% of Fiberglass.  
 Diffuser: Polycarbonate. Canopy: Steel.

**Light Source and electronics**

30 x LED STRIP 30V 5,8 W  
 Constant Voltage 30V  
 100~240V 50/60Hz

**Packaging**

2 Boxes  
 Total Vol 0,07120 m<sup>3</sup>  
 Gross weight 24 Kg Net weight 21,5 Kg

**Notes**

|  |          |
|--|----------|
| 2122-14 Built-in accessory (44,5 mm) chocolate | 125,00 € |
| 2122-58 Built-in accessory (44,5 mm) off-white | 125,00 € |

**Surface and built-in fitting**

Ø 18,5 cm Only for built-in.

# Rhythm Vertical

Design by Arik Levy

Evoking the mood of Zen minimalism, Rhythm features slender light modules of varying lengths, each fitted with an LED module, that can be arranged in endless configurations. Fluid and flowing or angular and anarchic, Rhythm represents the ultimate in customised lighting.

## Pendants

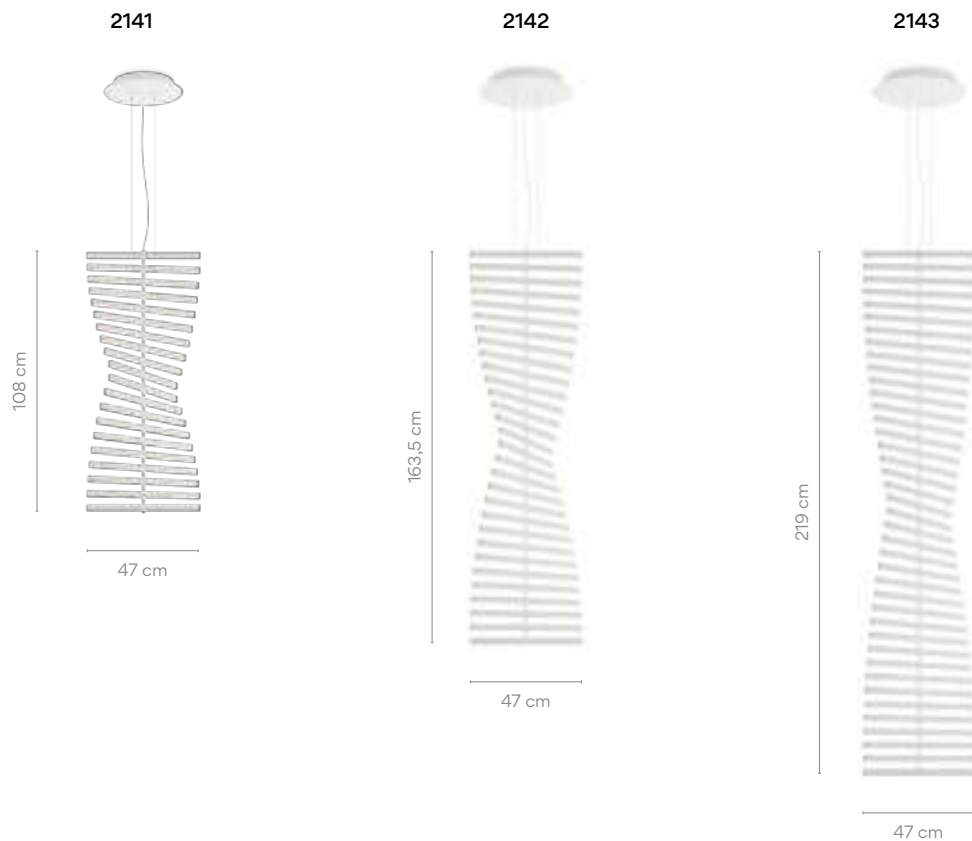

Each project is unique.  
Personalise your own  
Rhythm composition  
quick and easy.

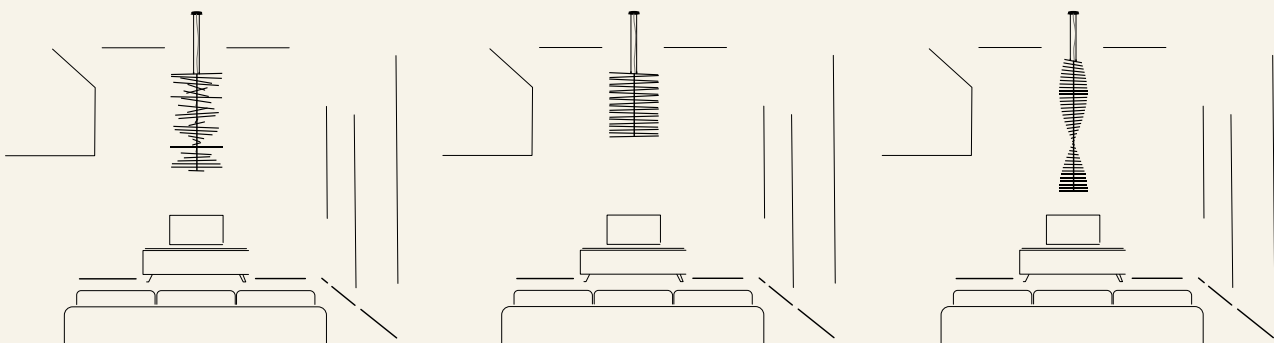



2141

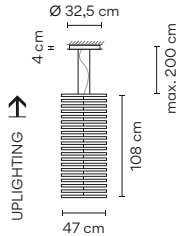

|                                     |  |
|-------------------------------------|--|
| <b>Finishes</b>                     | <b>LED temperature colour</b>            |
| ● 14/ __ Chocolate (RAL 8019)       | /1_ 2700 K  CRI >90 8664 lm 144 lm/W     |
| ● 58/ __ Off-white (RAL D2-1109005) | /3_ 3500 K  CRI >90 9157,3 lm 152,6 lm/W |

|                       |            |
|-----------------------|------------|
| <b>Control</b>        |            |
| 2141 __ / _ 1 DALI    | 2.650,00 € |
| 2141 __ / _ 3 1-10V   | 2.520,00 € |
| 2141 __ / _ Z Casambi | 2.640,00 € |

**Materials**

Stick: Polyamide 6 with 10% of Fiberglass.  
 Diffuser: Polycarbonate. Canopy: Steel.

**Light Source and electronics**

20 x LED STRIP 30V 2,9 W  
 Constant Voltage 30V  
 100~240V 50/60Hz

**Packaging**

2 Boxes  
 Total Vol 0,5850 m<sup>3</sup>  
 Gross weight 10,3 Kg Net weight 7,4 Kg

**Notes**

|  |          |
|--|----------|
| 2141-14 Built-in accessory (96 mm) chocolate | 125,00 € |
| 2141-58 Built-in accessory (96 mm) off-white | 125,00 € |

**Surface and built-in fitting**

Ø 18,5 cm Only for built-in.

2142

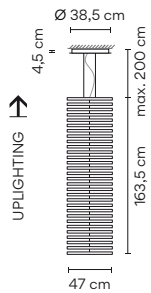

|                                     |   |
|-------------------------------------|---|
| <b>Finishes</b>                     | <b>LED temperature colour</b>           |
| ● 14/ __ Chocolate (RAL 8019)       | /1_ 2700 K  CRI >90 12996 lm 144 lm/W   |
| ● 58/ __ Off-white (RAL D2-1109005) | /3_ 3500 K  CRI >90 13736 lm 152,6 lm/W |

|                       |            |
|-----------------------|------------|
| <b>Control</b>        |            |
| 2142 __ / _ 1 DALI    | 3.940,00 € |
| 2142 __ / _ 3 1-10V   | 3.750,00 € |
| 2142 __ / _ Z Casambi | 3.870,00 € |

**Materials**

Stick: Polyamide 6 with 10% of Fiberglass.  
 Diffuser: Polycarbonate. Canopy: Steel.

**Light Source and electronics**

30 x LED STRIP 30V 2,9 W  
 Constant Voltage 30V  
 100~240V 50/60Hz

**Packaging**

2 Boxes  
 Total Vol 0,6239 m<sup>3</sup>  
 Gross weight 13,7 Kg Net weight 8,2 Kg

**Notes**

|  |          |
|--|----------|
| 2142-14 Built-in accessory (96 mm) chocolate | 125,00 € |
| 2142-58 Built-in accessory (96 mm) off-white | 125,00 € |

**Surface and built-in fitting**

Ø 18,5 cm Only for built-in.

2143

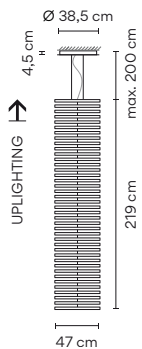

|                                     |  |
|-------------------------------------|--|
| <b>Finishes</b>                     | <b>LED temperature colour</b>            |
| ● 14/ __ Chocolate (RAL 8019)       | /1_ 2700 K  CRI >90 8664 lm 144 lm/W     |
| ● 58/ __ Off-white (RAL D2-1109005) | /3_ 3500 K  CRI >90 9157,3 lm 152,6 lm/W |

|                       |            |
|-----------------------|------------|
| <b>Control</b>        |            |
| 2143 __ / _ 1 DALI    | 4.970,00 € |
| 2143 __ / _ 3 1-10V   | 4.730,00 € |
| 2143 __ / _ Z Casambi | 4.850,00 € |

**Materials**

Stick: Polyamide 6 with 10% of Fiberglass.  
 Diffuser: Polycarbonate. Canopy: Steel.

**Light Source and electronics**

40 x LED STRIP 30V 2,9 W  
 Constant Voltage 30V  
 100~240V 50/60Hz

**Packaging**

2 Boxes  
 Total Vol 0,6600 m<sup>3</sup>  
 Gross weight 16,9 Kg Net weight 13 Kg

**Notes**

|  |          |
|--|----------|
| 2143-14 Built-in accessory (96 mm) chocolate | 125,00 € |
| 2143-58 Built-in accessory (96 mm) off-white | 125,00 € |

**Surface and built-in fitting**

Ø 18,5 cm Only for built-in.

# Guise

Design by Stefan Diez

Crafted of precision glass and embedded with a row of recessed LEDs, Guise explores the relationship between light and transparency. The light inside the glass appears invisible while the delicately engraved surface radiates an intense glow, the markings beautifully diffusing the light.

## Wall



2260

ø 54 cm



2262

ø 92 cm

### 2260

|  |   |                         |            |
|--|---|-------------------------|------------|
| <b>Finishes</b>                        | <b>LED temperature colour</b>   | <b>Control</b>          |            |
| ● 18/ __ Graphite<br>(ADAPTA RF9913WX) | /2_ 3000 K <br>CRI >90 445,29 lm 45 lm/W | 2260 __ / _ 6<br>Sensor | 1.110,00 € |

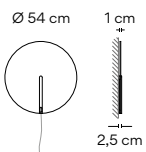

**Materials**  
Diffuser: Borosilicate glass. LED support: Aluminum.

**Light Source and electronics**  
1 x LED STRIP 24V 10 W  
Constant Voltage 24V  
100~240V 50/60Hz

**Packaging**  
1 Box 0,69 x 0,69 x 0,09 m  
Vol 0,043 m<sup>3</sup>  
Gross weight 7 Kg Net weight 4 Kg

**Notes**  
Electric cable with plug 3 m



### 2262

|  |   |                         |            |
|--|---|-------------------------|------------|
| <b>Finishes</b>                        | <b>LED temperature colour</b>   | <b>Control</b>          |            |
| ● 18/ __ Graphite<br>(ADAPTA RF9913WX) | /2_ 3000 K <br>CRI >90 897,71 lm 52 lm/W | 2262 __ / _ 6<br>Sensor | 2.355,00 € |

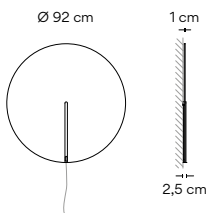

**Materials**  
Diffuser: Borosilicate glass. LED support: Aluminum.

**Light Source and electronics**  
1 x LED STRIP 24V 17,2 W.  
Constant Voltage 24V  
100~240V 50/60Hz

**Packaging**  
1 Box 1,04 x 1,04 x 0,10 m  
Vol 0,104 m<sup>3</sup>  
Gross weight 16,5 Kg Net weight 11,58 Kg

**Notes**  
Electric cable with plug 3 m



1160 | 10 | /1A  
Model | Finish |  
LED temperature colour |  
Control |



Pendants

2270



ø 16 cm

2271



ø 16 cm

2272



ø 16 cm

2275



63 cm

2277



89 cm

2282



ø 25 cm

2284



ø 25 cm

2288



ø 40 cm

2270

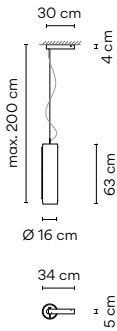

Finishes ● 18/ \_\_ Graphite (ADAPTA RF9913WX)  
 LED temperature colour /2\_ 3000 K [G] CRI >90 1097,74 lm 55 lm/W

Control 2270 \_\_ / \_ 1 1.855,00 € DALI-2  
 2270 \_\_ / \_ 6 1.765,00 € Sensor  
 2270 \_\_ / \_ Z 1.885,00 € Casambi

Materials Diffuser: Borosilicate glass. Body: Aluminum.

Light Source and electronics 1 x LED STRIP 24V 20 W Constant Voltage 24V 110-240V 50/60Hz

Packaging 1 Box 0,87 x 0,35 x 0,37 m Vol 0,113 m<sup>3</sup> Gross weight 6,5 Kg Net weight 5 Kg

Notes Extra cable length. 16,00 €/m  
 LED [IP20] [CE] [EAC] [Bi-volt] [Dimmer]

2271

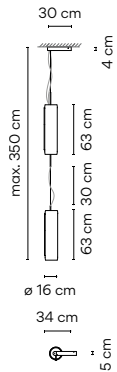

Finishes ● 18/ \_\_ Graphite (ADAPTA RF9913WX)  
 LED temperature colour /2\_ 3000 K [G] CRI >90 3484,8 lm 87,12 lm/W

Control 2271 \_\_ / \_ 1 3.305,00 € DALI-2  
 2271 \_\_ / \_ 3 3.145,00 € 1-10V

Materials Diffuser: Borosilicate glass. Body: Aluminum.

Light Source and electronics 2 x LED STRIP 24V 20 W Constant Voltage 24V 110-240V 50/60Hz

Packaging 2 Boxes Total Vol 0,231 m<sup>3</sup> Gross weight 13 Kg Net weight 10 Kg

Notes Electric cable with plug 2 m. Extra cable length. 16,00 €/m  
 UNTIL STOCK RUNS OUT  
 LED [IP20] [CE] [EAC] [Bi-volt] [Dimmer]

2272

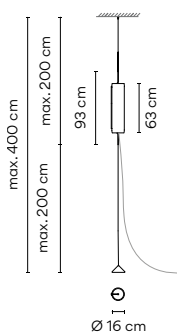

Finishes ● 18/ \_\_ Graphite (ADAPTA RF9913WX)  
 LED temperature colour /2\_ 3000 K [G] CRI >90 1097,74 lm 55 lm/W

Control 2272 \_\_ / \_ 6 1.710,00 € Sensor

Materials Diffuser: Borosilicate glass. LED support: Aluminum.

Light Source and electronics 1 x LED STRIP 24V 20 W Constant Voltage 24V 110-240V 50/60Hz

Packaging 1 Box 0,45 x 0,80 x 0,20 m Vol 0,0072 m<sup>3</sup> Gross weight 16,10 Kg Net weight 16,10 Kg

Notes Extra cable length. 16,00 €/m  
 LED [IP20] [CE] [EAC] [Bi-volt]

2275

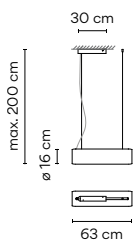

Finishes ● 18/ \_\_ Graphite (ADAPTA RF9913WX)  
 LED temperature colour /2\_ 3000 K [G] CRI >90 1404,68 lm 47 lm/W

Control 2275 \_\_ / \_ 1 1.805,00 € DALI-2  
 2275 \_\_ / \_ 6 1.715,00 € Sensor

Materials Diffuser: Borosilicate glass. Body: Aluminum.

Light Source and electronics 1 x LED STRIP 24V 20 W Constant Voltage 24V 110-240V 50/60Hz

Packaging 1 Box 0,87 x 0,35 x 0,37 m Vol 0,113 m<sup>3</sup> Gross weight 6,5 Kg Net weight 5 Kg

Notes Extra cable length. 16,00 €/m  
 UNTIL STOCK RUNS OUT  
 LED [IP20] [CE] [EAC] [Bi-volt] [Dimmer]

2277

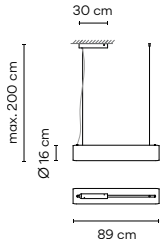

|   |  |  |
|---|--|--|
| <p><b>Finishes</b></p> <p>● <b>18/</b> _ _ Graphite<br/>(ADAPTA RF9913WX)</p> | <p><b>LED temperature colour</b></p> <p><b>/2</b> _ 3000 K  <b>6</b><br/>CRI &gt;90 1404,68 lm 47 lm/W</p> | <p><b>Control</b></p> <p><b>2277</b> _ _ / _ <b>1</b>      <b>1.980,00 €</b><br/>DALI-2</p> <hr/> <p><b>2277</b> _ _ / _ <b>6</b>      <b>1.885,00 €</b><br/>Sensor</p> <hr/> <p><b>2277</b> _ _ / _ <b>Z</b>      <b>2.005,00 €</b><br/>Casambi</p> |
|---|--|--|

|   |   |
|---|---|
| <p><b>Materials</b></p> <p>Diffuser: Borosilicate glass. Body: Aluminum.</p> <p><b>Light Source and electronics</b></p> <p>1 x LED STRIP 24V 30 W<br/>Constant Voltage 24V<br/>100~240V 50/60Hz</p> | <p><b>Packaging</b></p> <p>1 Box 1,18 x 0,35 x 0,37 m<br/>Vol 0,153 m<sup>3</sup><br/>Gross weight 9,5 Kg Net weight 7,5 Kg</p> <p><b>Notes</b></p> <p>Extra cable length. <b>16,00 €/m</b></p> <p> </p> <p> </p> |
|---|---|

2282

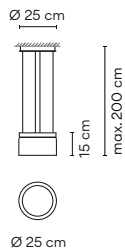

|   |   |   |
|---|---|---|
| <p><b>Finishes</b></p> <p>● <b>18/</b> _ _ Graphite<br/>(ADAPTA RF9913WX)</p> | <p><b>LED temperature colour</b></p> <p><b>/2</b> _ 3000 K  <b>6</b><br/>CRI &gt;90 398,74 lm 33 lm/W</p> | <p><b>Control</b></p> <p><b>2282</b> _ _ / _ <b>1</b>      <b>1.495,00 €</b><br/>DALI-2</p> <hr/> <p><b>2282</b> _ _ / _ <b>6</b>      <b>1.495,00 €</b><br/>Sensor</p> <hr/> <p><b>2282</b> _ _ / _ <b>B</b>      <b>1.420,00 €</b><br/>1-10V, Push</p> <hr/> <p><b>2282</b> _ _ / _ <b>Z</b>      <b>1.540,00 €</b><br/>Casambi</p> |
|---|---|---|

|  |   |
|--|---|
| <p><b>Materials</b></p> <p>Diffuser: Borosilicate glass. Body: Aluminum.<br/>Ceiling rose: Steel.</p> <p><b>Light Source and electronics</b></p> <p>1 x LED STRIP 24V 12 W<br/>Constant Voltage 24V<br/>110~240V 50/60Hz</p> | <p><b>Packaging</b></p> <p>1 Box 0,41 x 0,41 x 0,38 m<br/>Vol 0,0639 m<sup>3</sup><br/>Gross weight 3,3 Kg Net weight 2,3 Kg</p> <p><b>Notes</b></p> <p>Extra cable length. <b>16,00 €/m</b></p> <p> </p> |
|--|---|

2284

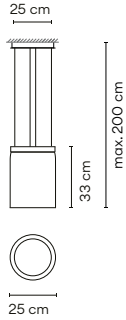

|   |  |
|---|--|
| <b>Finishes</b>                         | <b>LED temperature colour</b>  |
| ● 18/ _ _ Graphite<br>(ADAPTA RF9913WX) | /2 _ 3000 K <br>CRI >90 398,74 lm 33 lm/W |

|                               |            |
|-------------------------------|------------|
| <b>Control</b>                |            |
| 2284 _ _ / _ 1<br>DALI-2      | 1.670,00 € |
| 2284 _ _ / _ 6<br>Sensor      | 1.670,00 € |
| 2284 _ _ / _ B<br>1-10V, Push | 1.590,00 € |
| 2284 _ _ / _ Z<br>Casambi     | 1.710,00 € |

**Materials**  
 Diffuser: Borosilicate glass. Body: Aluminum.  
 Ceiling rose: Steel.

**Light Source and electronics**  
 1 x LED STRIP 24V 12 W  
 Constant Voltage 24V  
 110-240V 50/60Hz

**Packaging**  
 1 Box 0,41 x 0,41 x 0,56 m  
 Vol 0,0941 m<sup>3</sup>  
 Gross weight 6,2 Kg Net weight 5,2 Kg

**Notes**  
 Extra cable length. 16,00 €/m  
**UNTIL STOCK RUNS OUT**



2288

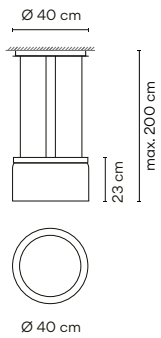

|   |   |
|---|---|
| <b>Finishes</b>                         | <b>LED temperature colour</b>   |
| ● 18/ _ _ Graphite<br>(ADAPTA RF9913WX) | /2 _ 3000 K <br>CRI >90 868,87 lm 48 lm/W |

|                               |            |
|-------------------------------|------------|
| <b>Control</b>                |            |
| 2288 _ _ / _ 1<br>DALI-2      | 3.225,00 € |
| 2288 _ _ / _ 6<br>Sensor      | 3.225,00 € |
| 2288 _ _ / _ B<br>1-10V, Push | 3.070,00 € |
| 2288 _ _ / _ Z<br>Casambi     | 3.190,00 € |

**Materials**  
 Diffuser: Borosilicate glass. Body: Aluminum.  
 Ceiling rose: Steel.

**Light Source and electronics**  
 1 x LED STRIP 24V 18 W  
 Constant Voltage 24V  
 110-240V 50/60Hz

**Packaging**  
 1 Box 0,56 x 0,56 x 0,46 m  
 Vol 0,1443 m<sup>3</sup>  
 Gross weight 11,7 Kg Net weight 9,7 Kg

**Notes**  
 Extra cable length. 16,00 €/m

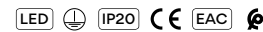

Ceiling

2292

ø 25 cm



2294

ø 25 cm



2298

ø 40 cm



2292



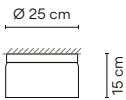

Finishes  
 ● 18/ \_ \_ Graphite (ADAPTA RF9913WX)  
 LED temperature colour  
 /2 \_ 3000 K  CRI >90 398,74 lm 33 lm/W

Control  
 2292 \_ \_ / \_ 1 DALI-2 1.390,00 €  
 2292 \_ \_ / \_ B 1-10V, Push 1.320,00 €  
 2292 \_ \_ / \_ Z Casambi 1.440,00 €



Materials  
 Diffuser: Borosilicate glass. Body: Aluminum.

Light Source and electronics  
 1 x LED STRIP 24V 12 W  
 Constant Voltage 24V  
 110-240V 50/60Hz

Packaging  
 1 Box 0,41 x 0,41 x 0,33 m  
 Vol 0,0555 m<sup>3</sup>  
 Gross weight 3,2 Kg Net weight 2,2 Kg  
    

2294

Finishes  
 ● 18/ \_ \_ Graphite (ADAPTA RF9913WX)  
 LED temperature colour  
 /2 \_ 3000 K  CRI >90 398,74 lm 33 lm/W

Control  
 2294 \_ \_ / \_ 1 DALI-2 1.570,00 €  
 2294 \_ \_ / \_ B 1-10V, Push 1.495,00 €  
 2294 \_ \_ / \_ Z Casambi 1.615,00 €

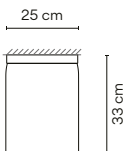

Materials  
 Diffuser: Borosilicate glass. Body: Aluminum.

Light Source and electronics  
 1 x LED STRIP 24V 12 W  
 Constant Voltage 24V  
 110-240V 50/60Hz

Packaging  
 1 Box 0,41 x 0,41 x 0,51 m  
 Vol 0,0857 m<sup>3</sup>  
 Gross weight 6,1 Kg Net weight 5,1 Kg

NOTES  
**UNTIL STOCK RUNS OUT**



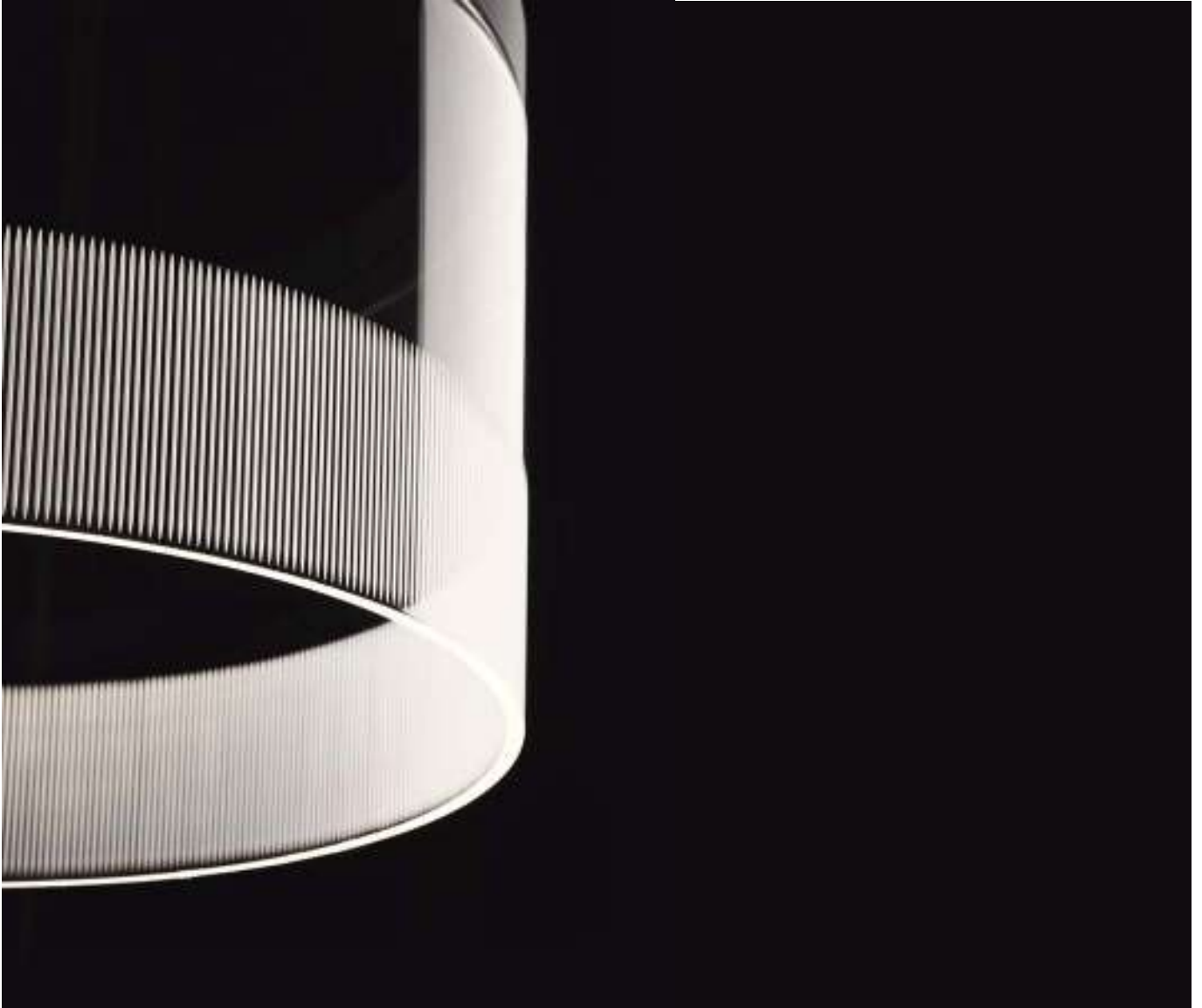

2298

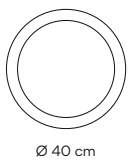
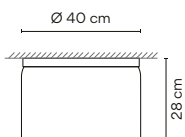

**Finishes**  
 ● 18/ \_ \_ Graphite (ADAPTA RF9913WX)

**LED temperature colour**  
 /2\_ 3000 K  CRI >90 398,74 lm 22 lm/W

**Control**

|                            |            |
|----------------------------|------------|
| 2298 _ _ / _ 1 DALI-2      | 3.315,00 € |
| 2298 _ _ / _ B 1-10V, Push | 3.155,00 € |
| 2298 _ _ / _ Z Casambi     | 3.275,00 € |

**Materials**  
 Diffuser: Borosilicate glass. Body: Aluminum.

**Light Source and electronics**  
 1 x LED STRIP 24V 18 W  
 Constant Voltage 24V  
 220~240V 50/60Hz

**Packaging**  
 1 Box 0,56 x 0,56 x 0,46 m  
 Vol 0,1443 m<sup>3</sup>  
 Gross weight 13,3 Kg Net weight 11,3 Kg

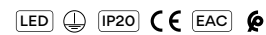

# Halo Circular

Design by Martín Azúa

A seamless merging of light and matter, Halo lends the effect of light floating in air. Powered by LED bulbs that remain invisible within their opalized, spherical moulds, the light flows freely from its source.

## Pendants



ø 55,5 cm

**2330**



89 cm

**2331**



127 cm

**2332**

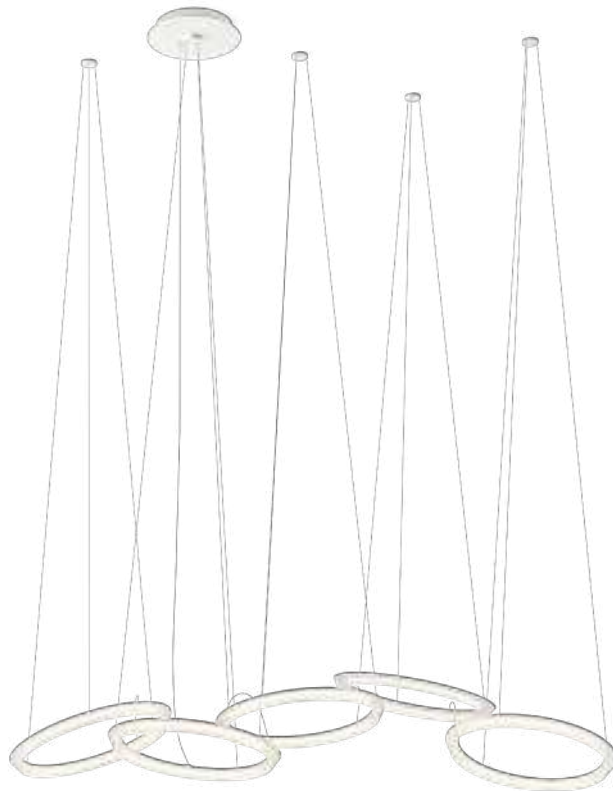

197 cm

**2333**

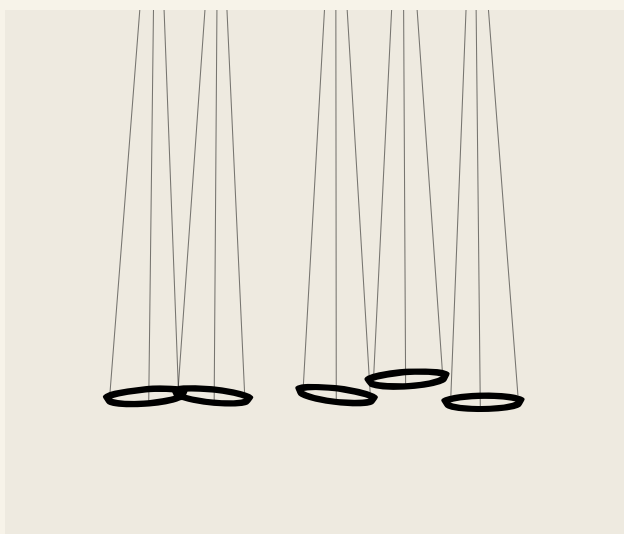
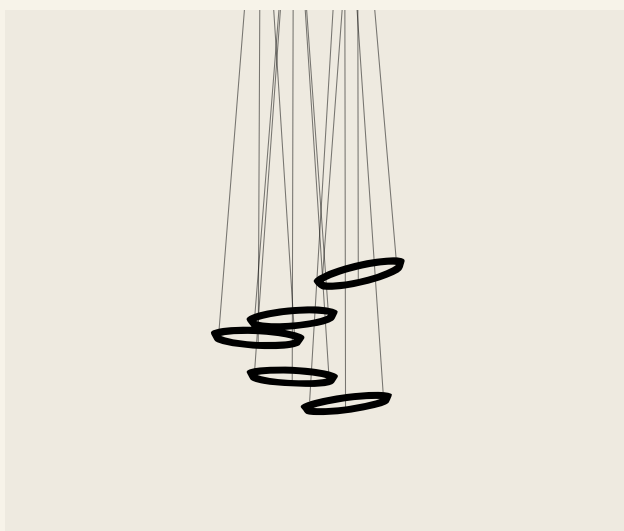

Each project is unique.  
Personalise your own  
Halo composition  
quick and easy.

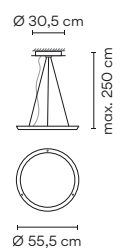

**2330**



**Finishes**  
 ● 03/ \_\_ White (RAL 9016)



**LED temperature colour**  
 /1\_ 2700 K  CRI >90 1904 lm 82 lm/W  
 /2\_ 3000 K  CRI >80 1726,78 lm 75 lm/W

**Control**  
 2330 \_\_ / \_ 1 1.045,00 €  
 DALI  
 2330 \_\_ / \_ 3 995,00 €  
 1-10V  
 2330 \_\_ / \_ Z 1.115,00 €  
 Casambi

**Materials**  
 Diffuser: PMMA. Canopy: Steel

**Light Source and electronics**  
 1 x LED STRIP 24V 23 W  
 Constant Voltage 24V  
 100~277V 50/60Hz



**Packaging**  
 1 Box 0,60 x 0,60 x 0,27 m  
 Vol 0,0972 m<sup>3</sup>  
 Gross weight 5,75 Kg Net weight 3,75 Kg

LED  IP20  EAC  Multi-volt

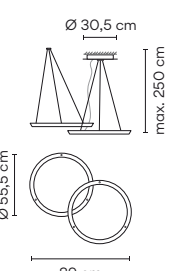
**2331**



**Finishes**  
 ● 03/ \_\_ White (RAL 9016)



**LED Colour Temperature**  
 /1\_ 2700 K  CRI >90 3808 lm 82 lm/W  
 /2\_ 3000 K  CRI >80 3453,56 lm 75 lm/W

**Control**  
 2331 \_\_ / \_ 1 2.095,00 €  
 DALI  
 2331 \_\_ / \_ 3 1.995,00 €  
 1-10V  
 2331 \_\_ / \_ Z 2.115,00 €  
 Casambi

**Materials**  
 Diffuser: PMMA. Canopy: Steel

**Light Source and electronics**  
 2 x LED STRIP 24V 23 W  
 Constant Voltage 24V  
 100~277V 50/60Hz



**Packaging**  
 1 Box 0,60 x 0,60 x 0,27 m  
 Vol 0,0972 m<sup>3</sup>  
 Gross weight 10,25 Kg Net weight 6,25 Kg

LED  IP20  EAC  Multi-volt

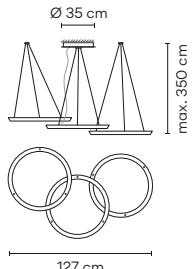
**2332**



**Finishes**  
 ● 03/ \_\_ White (RAL 9016)



**LED Colour Temperature**  
 /1\_ 2700 K  CRI >90 5712 lm 82 lm/W  
 /2\_ 3000 K  CRI >80 5180,34 lm 75 lm/W

**Control**  
 2332 \_\_ / \_ 1 3.145,00 €  
 DALI  
 2332 \_\_ / \_ 3 2.995,00 €  
 1-10V  
 2332 \_\_ / \_ Z 3.115,00 €  
 Casambi

**Materials**  
 Diffuser: PMMA. Canopy: Steel

**Light Source and electronics**  
 3 x LED STRIP 24V 23 W  
 Constant Voltage 24V  
 100~277V 50/60Hz



**Packaging**  
 1 Box 0,60 x 0,60 x 0,27 m  
 Vol 0,0972 m<sup>3</sup>  
 Gross weight 14,75 Kg Net weight 8,75 Kg

LED  IP20  EAC  Multi-volt

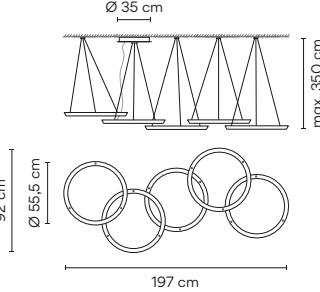
**2333**



**Finishes**  
 ● 03/ \_\_ White (RAL 9016)



**LED Colour Temperature**  
 /1\_ 2700 K  CRI >90 9520 lm 82 lm/W  
 /2\_ 3000 K  CRI >80 8633,9 lm 75 lm/W

**Control**  
 2333 \_\_ / \_ 1 5.245,00 €  
 DALI  
 2333 \_\_ / \_ 3 4.995,00 €  
 1-10V  
 2333 \_\_ / \_ Z 5.115,00 €  
 Casambi

**Materials**  
 Diffuser: PMMA. Canopy: Steel

**Light Source and electronics**  
 5 x LED STRIP 24V 23 W  
 Constant Voltage 24V  
 100~277V 50/60Hz

**Packaging**  
 2 Boxes  
 Total Vol 0,1106 m<sup>3</sup>  
 Gross weight 23,75 Kg Net weight 13,75 Kg

LED  IP20  EAC  Multi-volt



# Halo Lineal

Design by Martín Azúa

A seamless merging of light and matter, Halo lends the effect of light floating in air. Powered by LED bulbs that remain invisible within their opalized, linear moulds, the light flows freely from its source.

## Pendants

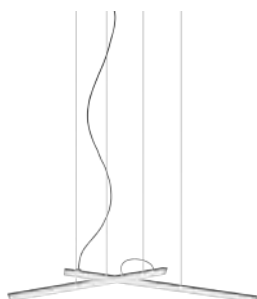

152 cm

**2340**



204 cm

**2341**

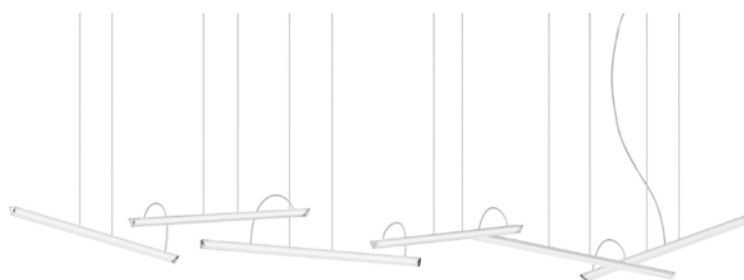

336 cm

**2342**



500 cm

**2343**

Each project is unique.  
Personalise your own  
Halo composition  
quick and easy.

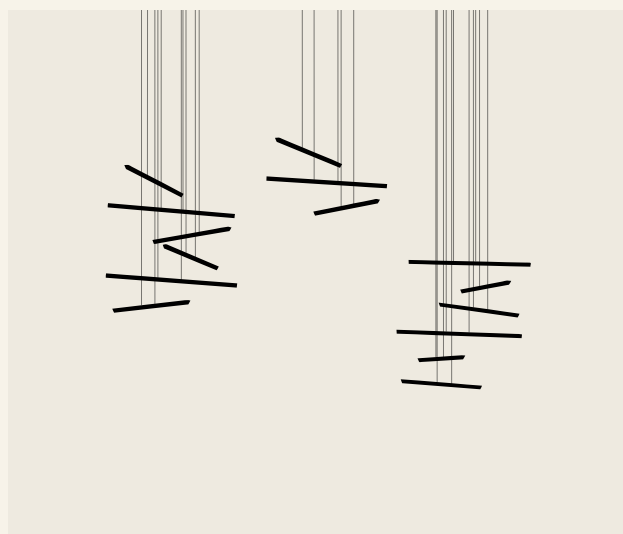
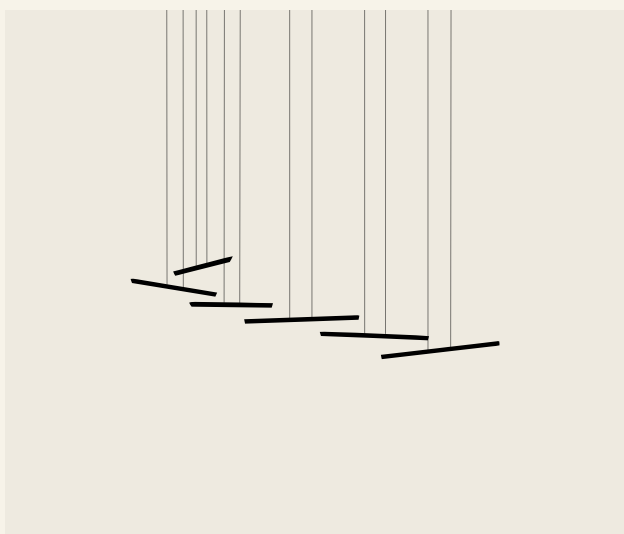
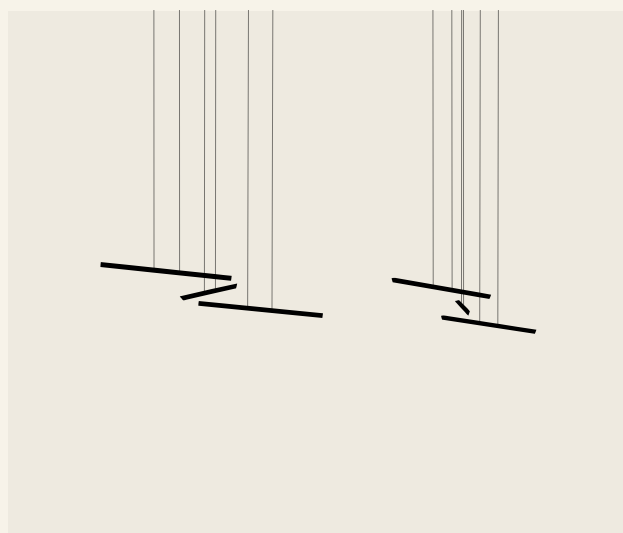
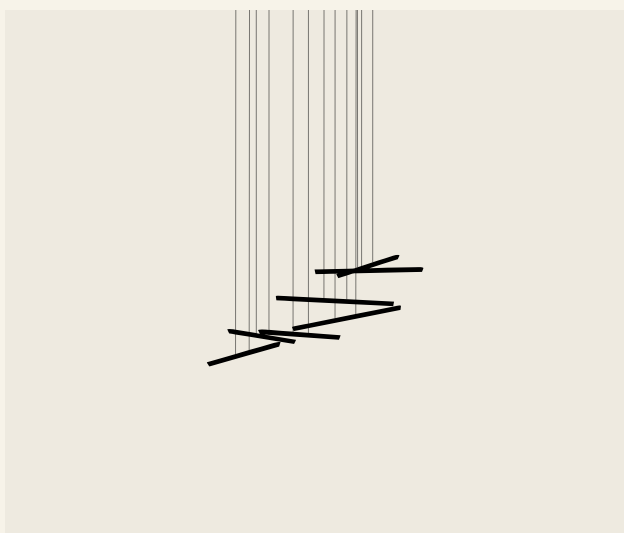

**2340**

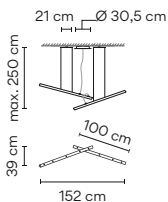

**Finishes**  
● **03/** \_\_ White (RAL 9016)

**LED Colour Temperature**  
/1 \_ 2700 K **F** →  
CRI >90 2831 lm 94 lm/W  
/2 \_ 3000 K **G** →  
CRI >80 2567,18 lm 84 lm/W

**Control**  
**2340** \_\_ / \_ 1 1.255,00 €  
DALI  
**2340** \_\_ / \_ 3 1.195,00 €  
1-10V  
**2340** \_\_ / \_ Z 1.315,00 €  
Casambi

**Materials**  
Diffuser: PMMA. Canopy: Steel

**Light Source and electronics**  
2 x LED STRIP 24V 15,3 W  
Constant Voltage 24V  
100~277V 50/60Hz

**Packaging**  
2 Boxes  
Total Vol 0,0753 m<sup>3</sup>  
Gross weight 6,2 Kg Net weight 5,58 Kg

LED ⓘ IP20 CE EAC ☑ Multi-volt

**2341**

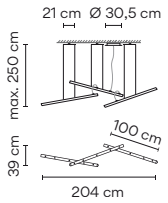

**Finishes**  
● **03/** \_\_ White (RAL 9016)

**LED Colour Temperature**  
/1 \_ 2700 K **F** →  
CRI >90 4246 lm 94 lm/W  
/2 \_ 3000 K **G** →  
CRI >80 3850,77 lm 84 lm/W

**Control**  
**2341** \_\_ / \_ 1 1.670,00 €  
DALI  
**2341** \_\_ / \_ 3 1.590,00 €  
1-10V  
**2341** \_\_ / \_ Z 1.710,00 €  
Casambi

**Materials**  
Diffuser: PMMA. Canopy: Steel

**Light Source and electronics**  
3 x LED STRIP 24V 15,3 W  
Constant Voltage 24V  
100~277V 50/60Hz

**Packaging**  
2 Boxes  
Total Vol 0,0753 m<sup>3</sup>  
Gross weight 7,3 Kg Net weight 6,57 Kg

LED ⓘ IP20 CE EAC ☑ Multi-volt

**2342**

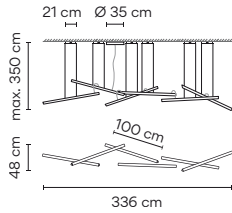

**Finishes**  
● **03/** \_\_ White (RAL 9016)

**LED Colour Temperature**  
/1 \_ 2700 K **F** →  
CRI >90 8492 lm 94 lm/W  
/2 \_ 3000 K **G** →  
CRI >80 7701,54 lm 84 lm/W

**Control**  
**2342** \_\_ / \_ 1 3.250,00 €  
DALI  
**2342** \_\_ / \_ 3 3.095,00 €  
1-10V  
**2342** \_\_ / \_ Z 3.215,00 €  
Casambi

**Materials**  
Diffuser: PMMA. Canopy: Steel

**Light Source and electronics**  
6 x LED STRIP 24V 15,3 W  
Constant Voltage 24V  
100~277V 50/60Hz

**Packaging**  
2 Boxes  
Total Vol 0,0756 m<sup>3</sup>  
Gross weight 11,8 Kg Net weight 10,25 Kg

LED ⓘ IP20 CE EAC ☑ Multi-volt

**2343**

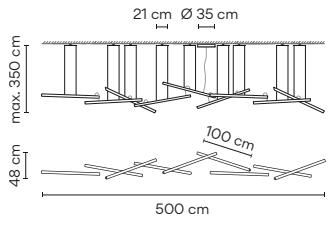

**Finishes**  
● **03/** \_\_ White (RAL 9016)

**LED Colour Temperature**  
/1 \_ 2700 K **F** →  
CRI >90 12739 lm 94 lm/W  
/2 \_ 3000 K **G** →  
CRI >80 11552,31 lm 84 lm/W

**Control**  
**2343** \_\_ / \_ 1 4.710,00 €  
DALI  
**2343** \_\_ / \_ 3 4.485,00 €  
1-10V  
**2343** \_\_ / \_ Z 4.605,00 €  
Casambi

**Materials**  
Diffuser: PMMA. Canopy: Steel

**Light Source and electronics**  
9 x LED STRIP 24V 15,3 W  
Constant Voltage 24V  
100~277V 50/60Hz

**Packaging**  
2 Boxes  
Total Vol 0,0756 m<sup>3</sup>  
Gross weight 16,20 Kg Net weight 14,75 Kg

LED ⓘ IP20 CE EAC ☑ Multi-volt





# Halo Jewel

Design by Martín Azúa

Subtle light floating in the air and delicately suspended by a perfectly crafted steel structure. Light and matter in one.

## Pendants

2350

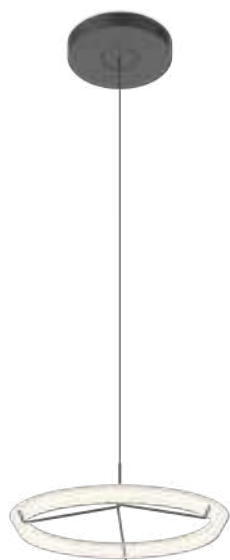

ø 56,3 cm

2351

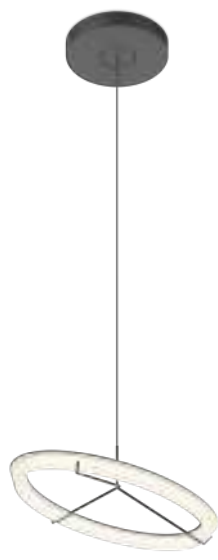

ø 56,3 cm

2355



max. 350 cm

2356



max. 350 cm



2350

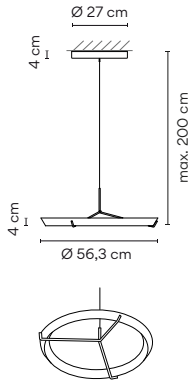

| Finishes                         | LED Colour Temperature                | Control                  |            |
|----------------------------------|---------------------------------------|--------------------------|------------|
| ● 11/ __ Black<br>(NCS S 8500-N) | /1_ 2700 K<br>CRI >90 1904 lm 83 lm/W | 2350 __ / _ 1<br>DALI    | 1.465,00 € |
|                                  | /2_ 3000 K<br>CRI >80 2024 lm 88 lm/W | 2350 __ / _ 3<br>1-10V   | 1.395,00 € |
|                                  |                                       | 2350 __ / _ Z<br>Casambi | 1.515,00 € |

| Finishes                | LED Colour Temperature                | Control                  |            |
|-------------------------|---------------------------------------|--------------------------|------------|
| ● 20/ __ Gold<br>(Gold) | /1_ 2700 K<br>CRI >90 1904 lm 83 lm/W | 2350 __ / _ 1<br>DALI    | 1.715,00 € |
|                         | /2_ 3000 K<br>CRI >80 2024 lm 88 lm/W | 2350 __ / _ 3<br>1-10V   | 1.645,00 € |
|                         |                                       | 2350 __ / _ Z<br>Casambi | 1.765,00 € |

Materials

Diffuser: Methacrylate. LED support: Aluminum.  
 Pendant structure: Steel. Ceiling rose: Steel.

Light Source and electronics

1 x LED STRIP 24V 23 W  
 Constant Voltage 24V  
 100~277V 50/60Hz

Packaging

1 Box 0,6 x 0,6 x 0,27 m  
 Vol 0,097 m<sup>3</sup>  
 Gross weight 7 Kg Net weight 6,35 Kg

Notes

Extra cable length. 16,00 €/m



Electrical connection

- Surface
- \_18 Free Wire
- \_23 Built-in
- \_31 Remote
- Micro for plaster ceilings
- \_32 Remote
- XXS for all types of drop ceilings

2351

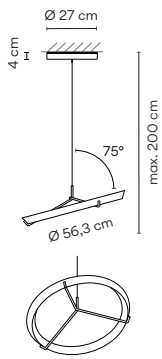

| Finishes                         | LED Colour Temperature                | Control                  |            |
|----------------------------------|---------------------------------------|--------------------------|------------|
| ● 11/ __ Black<br>(NCS S 8500-N) | /1_ 2700 K<br>CRI >90 1904 lm 83 lm/W | 2351 __ / _ 1<br>DALI    | 1.465,00 € |
|                                  | /2_ 3000 K<br>CRI >80 2024 lm 88 lm/W | 2351 __ / _ 3<br>1-10V   | 1.395,00 € |
|                                  |                                       | 2351 __ / _ Z<br>Casambi | 1.515,00 € |

| Finishes                | LED Colour Temperature                | Control                  |            |
|-------------------------|---------------------------------------|--------------------------|------------|
| ● 20/ __ Gold<br>(Gold) | /1_ 2700 K<br>CRI >90 1904 lm 83 lm/W | 2351 __ / _ 1<br>DALI    | 1.715,00 € |
|                         | /2_ 3000 K<br>CRI >80 2024 lm 88 lm/W | 2351 __ / _ 3<br>1-10V   | 1.645,00 € |
|                         |                                       | 2351 __ / _ Z<br>Casambi | 1.765,00 € |

Materials

Diffuser: Methacrylate. LED support: Aluminum.  
 Pendant structure: Steel. Ceiling rose: Steel.

Light Source and electronics

1 x LED STRIP 24V 23 W  
 Constant Voltage 24V  
 100~277V 50/60Hz

Packaging

1 Box 0,6 x 0,6 x 0,27 m  
 Vol 0,097 m<sup>3</sup>  
 Gross weight 7 Kg Net weight 6,35 Kg

Notes

Extra cable length. 16,00 €/m



Electrical connection

- Surface
- \_18 Free Wire
- \_23 Built-in
- \_31 Remote
- Micro for plaster ceilings
- \_32 Remote
- XXS for all types of drop ceilings

2355

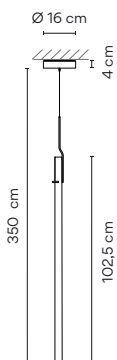

| Finishes                         | LED Colour Temperature                 | Control                  |          |
|----------------------------------|--|--------------------------|----------|
| ● 11/ __ Black<br>(NCS S 8500-N) | /1 _ 2700 K<br>CRI >90 1415 lm 94 lm/W | 2355 __ / _ 1<br>DALI    | 770,00 € |
|                                  | /2 _ 3000 K<br>CRI >80 1224 lm 80 lm/W | 2355 __ / _ 3<br>1-10V   | 730,00 € |
|                                  |  | 2355 __ / _ Z<br>Casambi | 850,00 € |

| Finishes                | LED Colour Temperature                 | Control                  |            |
|-------------------------|--|--------------------------|------------|
| ● 20/ __ Gold<br>(Gold) | /1 _ 2700 K<br>CRI >90 1415 lm 94 lm/W | 2355 __ / _ 1<br>DALI    | 1.020,00 € |
|                         | /2 _ 3000 K<br>CRI >80 1224 lm 80 lm/W | 2355 __ / _ 3<br>1-10V   | 980,00 €   |
|                         |  | 2355 __ / _ Z<br>Casambi | 1.100,00 € |

Materials

Diffuser: Methacrylate. LED support: Aluminum.  
Pendant structure: Steel. Ceiling rose: Steel.

Light Source and electronics

1 x LED STRIP 24V 15,3 W  
Constant Voltage 24V  
220-240V 50/60Hz

Packaging

1 Box 0,13 x 0,19 x 1,265 m  
Vol 0,0312 m<sup>3</sup>  
Gross weight 5 Kg Net weight 4,1 Kg

Notes

Extra cable length. 16,00 €/m



Electrical connection  
Surface  
\_18 Free Wire  
\_23 Built-in  
\_31 Remote  
Micro  
for plaster  
ceilings  
\_32 Remote  
XXS  
for all types  
of drop  
ceilings

2356

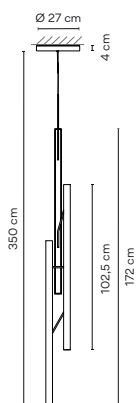

| Finishes                         | LED Colour Temperature                 | Control                  |            |
|----------------------------------|--|--------------------------|------------|
| ● 11/ __ Black<br>(NCS S 8500-N) | /1 _ 2700 K<br>CRI >90 4246 lm 94 lm/W | 2356 __ / _ 1<br>DALI    | 1.980,00 € |
|                                  | /2 _ 3000 K<br>CRI >80 3672 lm 80 lm/W | 2356 __ / _ 3<br>1-10V   | 1.885,00 € |
|                                  |  | 2356 __ / _ Z<br>Casambi | 2.005,00 € |

| Finishes                | LED Colour Temperature                 | Control                  |            |
|-------------------------|--|--------------------------|------------|
| ● 20/ __ Gold<br>(Gold) | /1 _ 2700 K<br>CRI >90 4246 lm 94 lm/W | 2356 __ / _ 1<br>DALI    | 2.230,00 € |
|                         | /2 _ 3000 K<br>CRI >80 3672 lm 80 lm/W | 2356 __ / _ 3<br>1-10V   | 2.135,00 € |
|                         |  | 2356 __ / _ Z<br>Casambi | 2.255,00 € |

Materials

Diffuser: Methacrylate. LED support: Aluminum.  
Pendant structure: Steel. Ceiling rose: Steel.

Light Source and electronics

3 x LED STRIP 24V 15,3 W  
Constant Voltage 24V  
100-277V 50/60Hz

Packaging

1 Box 0,31 x 0,33 x 2 m  
Vol 0,2046 m<sup>3</sup>  
Gross weight 7,4 Kg Net weight 6,06 Kg

Notes

Extra cable length. 16,00 €/m





# Composing pendants

Next sketches are composed by one or more compositions

---

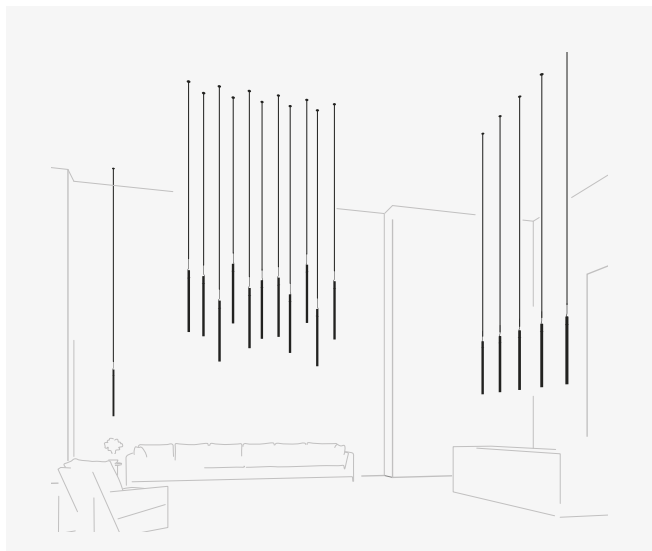

17 x 2355.



1 x 2350 and 2 x 2351.

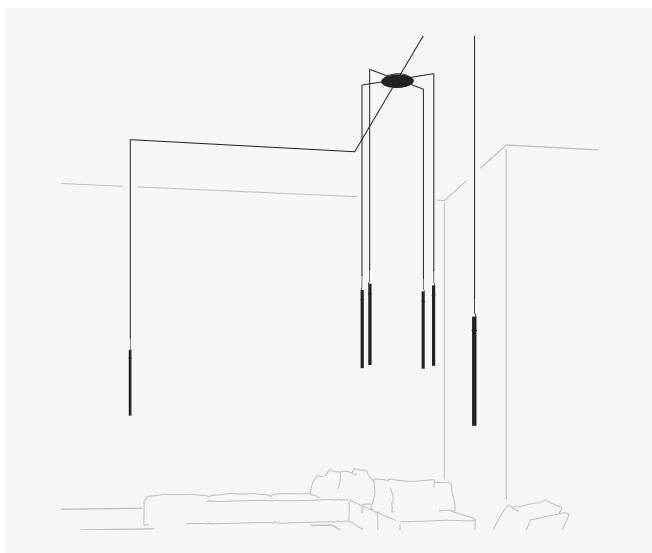

6 x 2355.

Each project is unique.  
Visit [vibia.com](http://vibia.com) and  
chose among multiple  
compositions designed  
and adapted to your  
project needs.

Personalise your own  
Halo composition quick  
and easy at [vibia.com](http://vibia.com)



# Electrical connection options for models 2350 / 2351 / 2355

Choose your preferred installation option  
according to your needs.  
For each composition, the optimal minimum  
number of drivers will be delivered.

## Drop ceiling

The innovative remote and built-in fittings accentuate  
the silkiness and lightness of compositions on  
suspended ceilings, its great visual grandeur taking  
center stage.

For Ref. 2350 / 2351 / 2355

### Remote

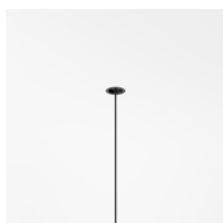

**Micro**  $\varnothing$  3 cm  
height 7 cm  
for plaster ceilings.  
Black finish.

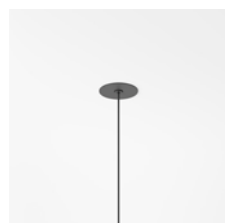
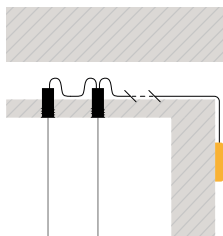

**XXS**  $\varnothing$  6 cm  
height 6 cm  
for all types of drop  
ceilings. Match with  
fixture finish.

### Built-in



$\varnothing$  8 cm  
height 6 cm  
match with  
fixture finish.

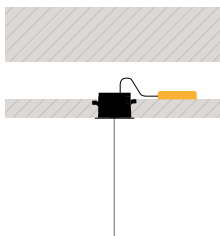



---

## Regular ceiling

When architecture does not allow for performance, surface and free wire showcase possibilities for any need or desire with no limits, ideal for both individual or cluster arrangements.

For Ref. 2350 / 2351

### Surface



ø 27 cm  
match with  
fixture finish.

### Free Wire



1 wire

ø 22 cm



2 - 6 wires

ø 36 cm



7 - 9 wires

ø 40 cm

---

For Ref. 2355

### Surface



ø 16 cm  
match with  
fixture finish.

### Free Wire



1 wire

ø 20 cm



2 - 6 wires

ø 36 cm



7 - 9 wires

ø 40 cm

you can choose the finish of the canopy  
among black, white or any colour  
matching one of the pendants.

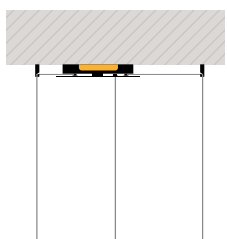
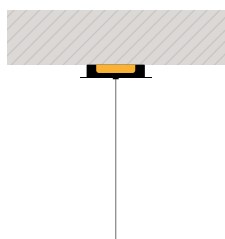

# Halo Wall

Design by Martín Azúa

A seamless merging of light and matter, Halo Wall lends the effect of light floating in the air and bathing the walls. A feature piece which creates subtle, magical light.

## Wall



2360

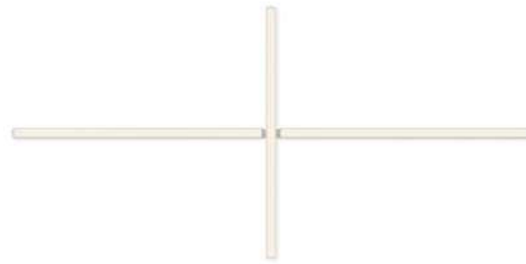

2361

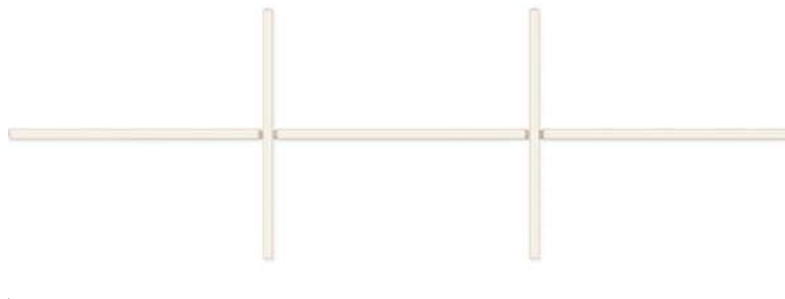

2362

### 2360

|   |  |
|---|--|
| <b>Finishes</b>                               | <b>LED Colour Temperature</b>          |
| ● <b>11/ _ _ Black</b><br>(NCS S 8500-N)      | /1 _ 2700 K<br>CRI >90 1415 lm 94 lm/W |
| ● <b>13/ _ _ Warm White</b><br>(NCS S 1000-N) | /2 _ 3000 K<br>CRI >80 1224 lm 80 lm/W |

|                                  |                 |
|----------------------------------|-----------------|
| <b>Control</b>                   |                 |
| <b>2360 _ _ / _ 1</b><br>DALI    | <b>695,00 €</b> |
| <b>2360 _ _ / _ 3</b><br>1-10V   | <b>660,00 €</b> |
| <b>2360 _ _ / _ Z</b><br>Casambi | <b>780,00 €</b> |

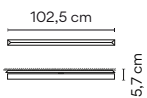



**Materials**  
Diffuser: Methacrylate. LED support: Aluminum.

**Light Source and electronics**  
1 x LED STRIP 24V 15,3 W  
Constant Voltage 24V  
220-240V 50/60Hz

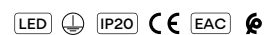
**Packaging**  
1 Box 0,10 x 1,025 x 0,10 m  
Vol 0,01 m<sup>3</sup>  
Gross weight 2,25 Kg Net weight 1,75 Kg



**2361**

- |  |   |
|--|---|
| <b>Finishes</b>                              | <b>LED Colour Temperature</b>   |
| ● <b>11/ __ Black</b><br>(NCS S 8500-N)      | /1 _ 2700 K  |
| ● <b>13/ __ Warm White</b><br>(NCS S 1000-N) | /2 _ 3000 K  |

|                                 |                   |
|---------------------------------|-------------------|
| <b>Control</b>                  |                   |
| <b>2361 __ / _ 1</b><br>DALI    | <b>1.595,00 €</b> |
| <b>2361 __ / _ 3</b><br>1-10V   | <b>1.515,00 €</b> |
| <b>2361 __ / _ Z</b><br>Casambi | <b>1.635,00 €</b> |

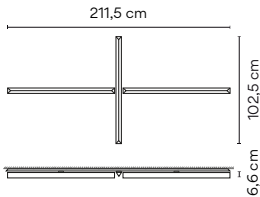

**Materials**  
 Diffuser: Methacrylate. LED support: Aluminum.

**Light Source and electronics**  
 3 x LED STRIP 24V 15,3 W  
 Constant Voltage 24V  
 220-240V 50/60Hz



**Packaging**  
 1 Box 0,15 x 2,20 x 0,15 m  
 Vol 0,05 m<sup>3</sup>  
 Gross weight 5,5 Kg Net weight 4,5 Kg

**Notes**  
 The rotation around a central axis allows for movement of the light sticks in the desired position: perpendicular, vertical, diagonal and progressive, creating wall arts in the space.

**UNTIL STOCK RUNS OUT**



**2362**

- |  |   |
|--|---|
| <b>Finishes</b>                              | <b>LED Colour Temperature</b>   |
| ● <b>11/ __ Black</b><br>(NCS S 8500-N)      | /1 _ 2700 K   |
| ● <b>13/ __ Warm White</b><br>(NCS S 1000-N) | /2 _ 3000 K  |

|                                 |                   |
|---------------------------------|-------------------|
| <b>Control</b>                  |                   |
| <b>2362 __ / _ 1</b><br>DALI    | <b>2.590,00 €</b> |
| <b>2362 __ / _ 3</b><br>1-10V   | <b>2.465,00 €</b> |
| <b>2362 __ / _ Z</b><br>Casambi | <b>2.585,00 €</b> |

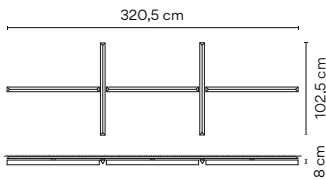

**Materials**  
 Diffuser: Methacrylate. LED support: Aluminum.

**Light Source and electronics**  
 5 x LED STRIP 24V 15,3 W  
 Constant Voltage 24V  
 220-240V 50/60Hz

**Packaging**  
 1 Box 0,15 x 3,40 x 0,15 m  
 Vol 0,077 m<sup>3</sup>  
 Gross weight 9,5 Kg Net weight 7,5 Kg

**Notes**  
 The rotation around a central axis allows for movement of the light sticks in the desired position: perpendicular, vertical, diagonal and progressive, creating wall arts in the space.

**UNTIL STOCK RUNS OUT**

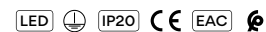

# Cosmos

Design by Lievore, Altherr, Molina

Design and light become one with Cosmos pendant. Flattened spheres in suspension that naturally descend from the ceiling and use light to draw a fluctuating course like a constellation of stars.

## Pendants



ø 19 cm

2500



ø 27 cm

2501



ø 48 cm

2502



55 cm

2510



55 cm

2511



76 cm

2515



86 cm

2516

### 2500

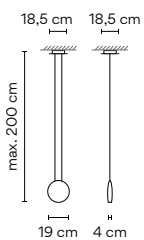

#### Finishes

- 14/ \_\_ Chocolate (RAL 8019)
- 62/ \_\_ Green (PANTONE 5645)
- 66/ \_\_ Light-grey (PANTONE 403)

#### LED temperature colour

- /1\_ 2700 K CRI >80 485 lm 121 lm/W
- /3\_ 3500 K CRI >90 512,6 lm 128,2 lm/W

#### Control

|               |          |
|---------------|----------|
| 2500 __ / _ 0 | 330,00 € |
| On/ Off       |          |
| 2500 __ / _ 1 | 350,00 € |
| DALI-2        |          |
| 2500 __ / _ Z | 450,00 € |
| Casambi       |          |

#### Materials

Diffuser: Polycarbonate. Body: ABS.  
Canopy Plate: Steel.

#### Light Source and electronics

1 x LED 4,5 W 350mA  
Constant Current 350 mA  
/ 10: 100-240V 50/60Hz  
/ 1B: 110-240V 50/60Hz

#### Packaging

1 Box 0,26 x 0,26 x 0,26 m  
Vol 0,0180 m<sup>3</sup>  
Gross weight 1,62 Kg Net weight 1,18 Kg

#### Notes

Extra cable length. 16,00 €/m

2501

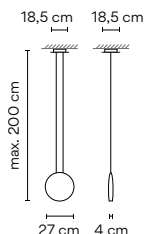

| Finishes                          | LED temperature colour                  | Control               |          |
|-----------------------------------|---|-----------------------|----------|
| ● 14/ __ Chocolate (RAL 8019)     | /1_ 2700 K  CRI >80 485 lm 121 lm/W     | 2501 __ / _ 0 On/ Off | 365,00 € |
| ● 62/ __ Green (PANTONE 5645)     | /3_ 3500 K  CRI >90 512,6 lm 128,2 lm/W | 2501 __ / _ 1 DALI-2  | 385,00 € |
| ● 66/ __ Light-grey (PANTONE 403) |   | 2501 __ / _ Z Casambi | 485,00 € |

**Materials**  
 Diffuser: Polycarbonate. Body: ABS.  
 Canopy Plate: Steel.

**Light Source and electronics**  
 1 x LED 4,5 W 350mA  
 Constant Current 350 mA  
 / 10: 100-240V 50/60Hz  
 / 1B: 110-240V 50/60Hz

**Packaging**  
 1 Box 0,42 x 0,42 x 0,25 m  
 Vol 0,0441 m<sup>3</sup>  
 Gross weight 2,54 Kg Net weight 1,44 Kg

**Notes**  
 Extra cable length. 16,00 €/m

LED IP20

2502

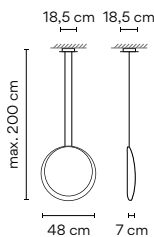

| Finishes                  | LED temperature colour                  | Control                   |          |
|---------------------------|---|---------------------------|----------|
| ● 03/ __ White (RAL 9010) | /1_ 2700 K  CRI >80 485 lm 121 lm/W     | 2502 __ / _ 1 DALI-2      | 785,00 € |
|                           | /3_ 3500 K  CRI >90 512,6 lm 128,2 lm/W | 2502 __ / _ B 1-10V, Push | 745,00 € |
|                           |   | 2502 __ / _ Z Casambi     | 865,00 € |

**Materials**  
 Diffuser: Polycarbonate. Body: Polyurethane.  
 Canopy Plate: Steel.

**Light Source and electronics**  
 1 x LED 4,5 W 350 mA.  
 1 x LED 1 W 350 mA.  
 Constant Current 350 mA  
 110-240V 50/60Hz

**Packaging**  
 1 Box 0,60 x 0,60 x 0,27 m  
 Vol 0,0970 m<sup>3</sup>  
 Gross weight 5,58 Kg Net weight 3,15 Kg

**Notes**  
 Extra cable length. 16,00 €/m

LED IP20

2510

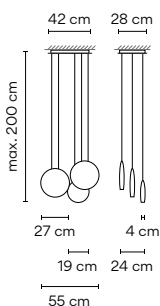

| Finishes   | LED temperature colour                   | Control                           |            |
|--|--|-----------------------------------|------------|
| ● 62/ __ Green, Chocolate and Light-grey (PANTONE 5645, RAL 8019, PANTONE 403) | /1_ 2700 K  CRI >80 1455 lm 121 lm/W     | 2510 __ / _ A DALI-2, 1-10V, Push | 995,00 €   |
|  | /3_ 3500 K  CRI >90 1537,8 lm 128,2 lm/W | 2510 __ / _ Z Casambi             | 1.115,00 € |

**Materials**  
 Diffuser: Polycarbonate. Body: ABS.  
 Canopy Plate: Steel.

**Light Source and electronics**  
 3 x LED 4,5 W 350 mA  
 Constant Current 350 mA  
 110-240V 50/60Hz

**Packaging**  
 1 Box 0,60 x 0,60 x 0,27 m  
 Vol 0,0970 m<sup>3</sup>  
 Gross weight 7,54 Kg Net weight 5,11 Kg

**Notes**  
 Compositions and finishes can not be changed  
 Extra cable length. 16,00 €/m

LED IP20

|  |  |   |  |  |
|--|--|---|--|--|
|  | <b>2511</b>  | <b>Finishes</b><br>62/ __ Green, White and Chocolate (PANTONE 5645, RAL 9010, RAL 8019)<br>66/ __ Light-grey, White and Chocolate (PANTONE 403, RAL 9010, RAL 8019) | <b>LED temperature colour</b><br>/1 _ 2700 K  CRI >80 1455 lm 121 lm/W<br>/3 _ 3500 K  CRI >90 1537,8 lm 128,2 lm/W              | <b>Control</b><br>2511 __ / _ A 1.370,00 €<br>DALI-2, 1-10V, Push<br>2511 __ / _ Z 1.490,00 €<br>Casambi |
|  | <b>Materials</b><br>Diffuser: Polycarbonate. Body: ABS + Polyurethane.<br>Canopy Plate: Steel. | <b>Packaging</b><br>1 Box 0,60 x 0,60 x 0,27 m<br>Vol 0,0970 m <sup>3</sup><br>Gross weight 9,25 Kg Net weight 6,82 Kg  | <b>Light Source and electronics</b><br>3 x LED 4,5 W 350 mA<br>1 x LED 1 W 350 mA<br>Constant Current 350 mA<br>110-240V 50/60Hz | <b>Notes</b><br>Compositions and finishes can not be changed<br>Extra cable length. 16,00 €/m            |

|  |   |   |   |  |
|--|---|---|---|--|
|  | <b>2515</b>   | <b>Finishes</b><br>62/ __ Green, Chocolate and Light-grey (PANTONE 5645, RAL 8019, PANTONE 403)                         | <b>LED temperature colour</b><br>/1 _ 2700 K  CRI >80 1940 lm 121 lm/W<br>/3 _ 3500 K  CRI >90 2050,5 lm 128,2 lm/W | <b>Control</b><br>2515 __ / _ A 1.245,00 €<br>DALI-2, 1-10V, Push<br>2515 __ / _ Z 1.365,00 €<br>Casambi |
|  | <b>Materials</b><br>Diffuser: Polycarbonate. Body: ABS.<br>Canopy Plate: Steel. | <b>Packaging</b><br>1 Box 0,76 x 0,76 x 0,27 m<br>Vol 0,1560 m <sup>3</sup><br>Gross weight 10,94 Kg Net weight 7,04 Kg | <b>Light Source and electronics</b><br>4 x LED 4,5 W 350 mA<br>Constant Current 350 mA<br>110-240V 50/60Hz          | <b>Notes</b><br>Compositions and finishes can not be changed<br>Extra cable length. 16,00 €/m            |

|  |  |   |   |  |
|--|--|---|---|--|
|  | <b>2516</b>  | <b>Finishes</b><br>62/ __ Green, White and Chocolate (PANTONE 5645, RAL 9010, RAL 8019)                             | <b>LED temperature colour</b><br>/1 _ 2700 K  CRI >80 1940 lm 121 lm/W  | <b>Control</b><br>2516 __ / _ A 1.925,00 €<br>DALI-2, 1-10V, Push<br>2516 __ / _ Z 2.045,00 €<br>Casambi |
|  | <b>Materials</b><br>Diffuser: Polycarbonate. Body: ABS + Polyurethane.<br>Canopy Plate: Steel. | <b>Packaging</b><br>1 Box 0,73x0,73x0,32 m<br>Vol 0,1705 m <sup>3</sup><br>Gross weight 14,62 Kg Net weight 15,5 Kg | <b>Light Source and electronics</b><br>4 x LED 4,5 W 350 mA<br>2x LED 1 W 350 mA<br>Constant Current 350 mA<br>110-240V 50/60Hz | <b>Notes</b><br>Compositions and finishes can not be changed<br>Extra cable length. 16,00 €/m            |







# Structural

Design by Arik Levy

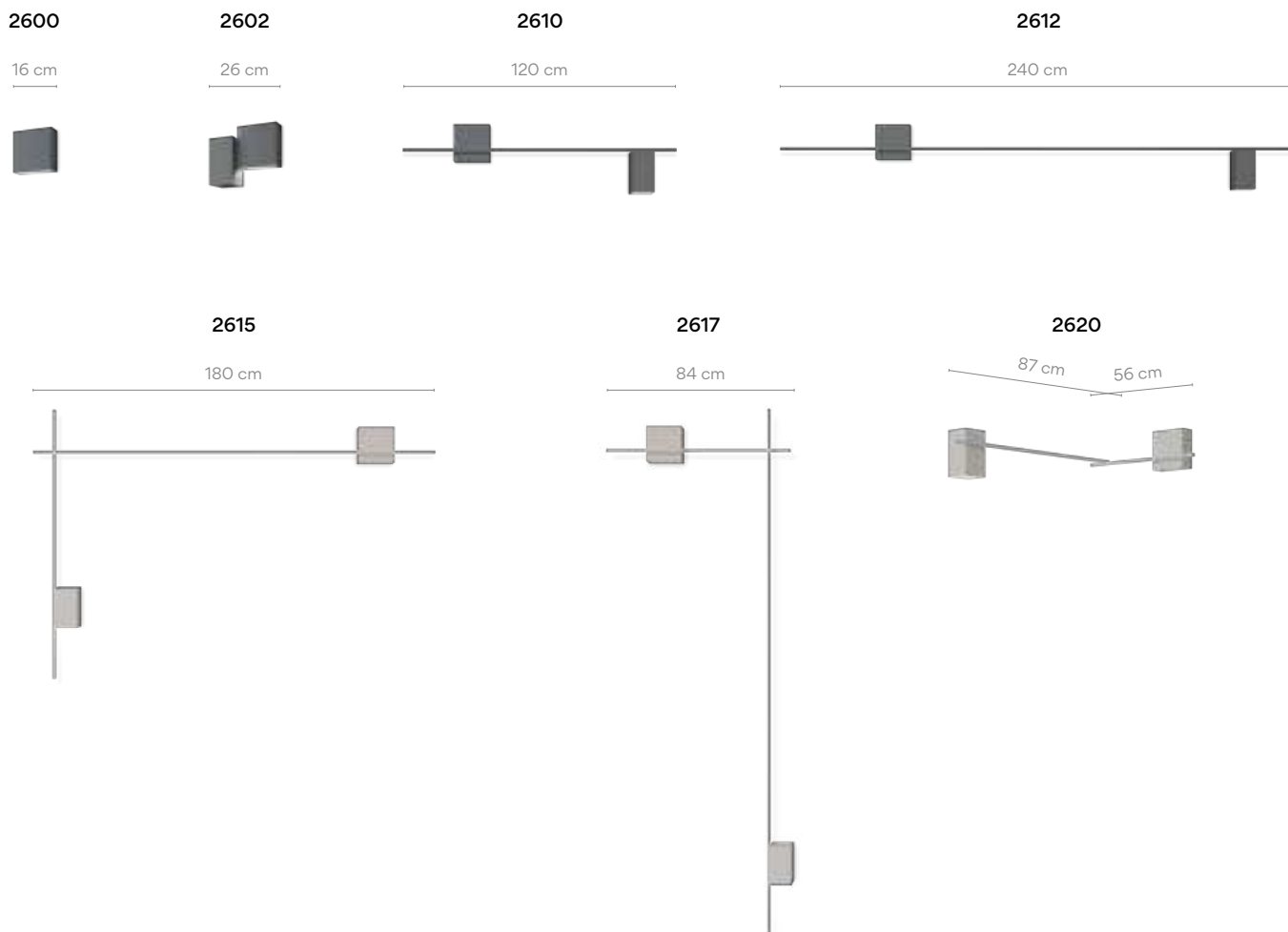
Structural's cubic forms pair with slender metal rods that both join and separate the volumes, providing points of light connected in space. Its design deconstructs the light source and casts it in unexpected places, creating sculptural pieces integrated in the architecture.

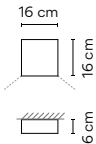
## Wall



|  |  |   |  |                                 |                 |                                |                 |                                  |                 |
|--|--|---|--|---------------------------------|-----------------|--------------------------------|-----------------|----------------------------------|-----------------|
| <b>2600</b><br>   | <b>Finishes</b><br><ul style="list-style-type: none"> <li>● <b>21/ _ _ Black Grey</b><br/>(NCS S 7000-N)</li> <li>● <b>15/ _ _ Grey L2</b><br/>(NCS S 2500-N)</li> </ul> <b>Finish customization</b><br>(Available options:<br>Vibia colour palette) | <b>LED Colour Temperature</b><br><ul style="list-style-type: none"> <li><b>/1_ 2700 K</b>  <br/>CRI &gt;90 700 lm 117 lm/W</li> <li><b>/2_ 3000 K</b>  <br/>CRI &gt;90 756,73 lm 126 lm/W</li> <li><b>/3_ 3500 K</b>  <br/>CRI &gt;90 763,3 lm 127,2 lm/W</li> </ul> | <b>Control</b><br><table border="0"> <tr> <td><b>2600 _ _ / _ 1</b><br/>DALI-2</td> <td style="text-align: right;"><b>415,00 €</b></td> </tr> <tr> <td><b>2600 _ _ / _ 3</b><br/>1-10V</td> <td style="text-align: right;"><b>395,00 €</b></td> </tr> <tr> <td><b>2600 _ _ / _ Z</b><br/>Casambi</td> <td style="text-align: right;"><b>515,00 €</b></td> </tr> </table> | <b>2600 _ _ / _ 1</b><br>DALI-2 | <b>415,00 €</b> | <b>2600 _ _ / _ 3</b><br>1-10V | <b>395,00 €</b> | <b>2600 _ _ / _ Z</b><br>Casambi | <b>515,00 €</b> |
|  | <b>2600 _ _ / _ 1</b><br>DALI-2  | <b>415,00 €</b>   |  |                                 |                 |                                |                 |                                  |                 |
| <b>2600 _ _ / _ 3</b><br>1-10V   | <b>395,00 €</b>  |   |  |                                 |                 |                                |                 |                                  |                 |
| <b>2600 _ _ / _ Z</b><br>Casambi   | <b>515,00 €</b>  |   |  |                                 |                 |                                |                 |                                  |                 |
| <b>Materials</b><br>Diffuser: Polycarbonate. Main body: Aluminum.<br>Structures: Aluminum.<br><br><b>Light Source and electronics</b><br>1 x LED PLATE 24V 6 W<br>Constant Voltage 24V<br>110-240V 50/60Hz | <b>Packaging</b><br>1 Box 0,4 x 0,4 x 0,2 m<br>Vol 0,032 m³<br>Gross weight 1,35 Kg Net weight 0,9 Kg<br><br>  |   |  |                                 |                 |                                |                 |                                  |                 |



2602

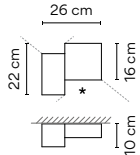

| Finishes   | LED Colour Temperature                    | Control                |          |
|--|---|------------------------|----------|
| ● 21/ _ _ Black Grey (NCS S 7000-N)                            | /1 _ 2700 K  CRI >90 1400 lm 117 lm/W     | 2602 _ _ / _ 1 DALI-2  | 695,00 € |
| ● 15/ _ _ Grey L2 (NCS S 2500-N)                               | /2 _ 3000 K  CRI >90 1513,46 lm 126 lm/W  | 2602 _ _ / _ 3 1-10V   | 660,00 € |
| Finish customization (Available options: Vibia colour palette) | /3 _ 3500 K  CRI >90 1526,5 lm 127,2 lm/W | 2602 _ _ / _ Z Casambi | 780,00 € |

**Materials**  
 Diffuser: Polycarbonate. Main body: Aluminum.  
 Structures: Aluminum.

**Light Source and electronics**  
 2 x LED PLATE 24V 6 W  
 Constant Voltage 24V  
 110-240V 50/60Hz

**Packaging**  
 1 Box 0,4 x 0,4 x 0,2 m  
 Vol 0,032 m<sup>3</sup>  
 Gross weight 2,85 Kg Net weight 1,9 Kg

**Notes**  
 \* Electrical connection point.



2610

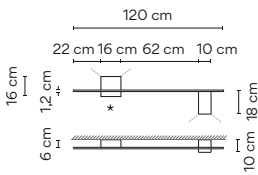

| Finishes   | LED Colour Temperature                    | Control                |          |
|--|---|------------------------|----------|
| ● 21/ _ _ Black Grey (NCS S 7000-N)                            | /1 _ 2700 K  CRI >90 1400 lm 117 lm/W     | 2610 _ _ / _ 1 DALI-2  | 835,00 € |
| ● 15/ _ _ Grey L2 (NCS S 2500-N)                               | /2 _ 3000 K  CRI >90 1513,46 lm 126 lm/W  | 2610 _ _ / _ 3 1-10V   | 795,00 € |
| Finish customization (Available options: Vibia colour palette) | /3 _ 3500 K  CRI >90 1526,5 lm 127,2 lm/W | 2610 _ _ / _ Z Casambi | 915,00 € |

**Materials**  
 Diffuser: Polycarbonate. Main body: Aluminum.  
 Structures: Aluminum.

**Light Source and electronics**  
 1 x LED PLATE 24V 6 W  
 Constant Voltage 24V  
 110-240V 50/60Hz

**Packaging**  
 2 Boxes  
 Total Vol 0,036 m<sup>3</sup>  
 Gross weight 3,6 Kg Net weight 2,4 Kg

**Notes**  
 \* Electrical connection point.



2612

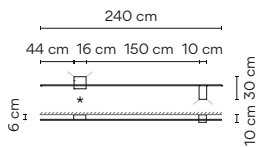

| Finishes   | LED Colour Temperature                    | Control                |          |
|--|---|------------------------|----------|
| ● 21/ _ _ Black Grey (NCS S 7000-N)                            | /1 _ 2700 K  CRI >90 1400 lm 117 lm/W     | 2612 _ _ / _ 1 DALI-2  | 910,00 € |
| ● 15/ _ _ Grey L2 (NCS S 2500-N)                               | /2 _ 3000 K  CRI >90 1513,46 lm 126 lm/W  | 2612 _ _ / _ 3 1-10V   | 865,00 € |
| Finish customization (Available options: Vibia colour palette) | /3 _ 3500 K  CRI >90 1526,5 lm 127,2 lm/W | 2612 _ _ / _ Z Casambi | 985,00 € |

**Materials**  
 Diffuser: Polycarbonate. Main body: Aluminum.  
 Structures: Aluminum.

**Light Source and electronics**  
 2 x LED PLATE 24V 6 W  
 Constant Voltage 24V  
 110-240V 50/60Hz







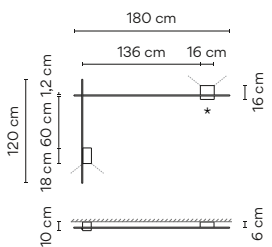

**Packaging**  
 2 Boxes  
 Total Vol 0,042 m<sup>3</sup>  
 Gross weight 3,9 Kg Net weight 2,6 Kg

**Notes**  
 \* Electrical connection point.









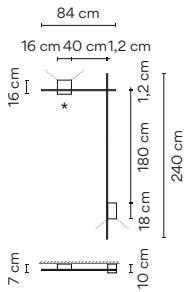

**2615**



|   |  |   |                                 |                   |                                |                 |                                  |                   |
|---|--|---|---------------------------------|-------------------|--------------------------------|-----------------|----------------------------------|-------------------|
| <p><b>Finishes</b></p> <ul style="list-style-type: none"> <li>● <b>21/ _ _ Black Grey</b><br/>(NCS S 7000-N)</li> <li>● <b>15/ _ _ Grey L2</b><br/>(NCS S 2500-N)</li> </ul> <p><b>Finish customization</b><br/>(Available options:<br/>Vibia colour palette)</p> | <p><b>LED Colour Temperature</b></p> <ul style="list-style-type: none"> <li>/1_ 2700 K  CRI &gt;90 1400 lm 117 lm/W</li> <li>/2_ 3000 K  CRI &gt;90 1513,46 lm 126 lm/W</li> <li>/3_ 3500 K  CRI &gt;90 1526,5 lm 127,2 lm/W</li> </ul> | <p><b>Control</b></p> <table border="1"> <tr> <td><b>2615 _ _ / _ 1</b><br/>DALI-2</td> <td><b>1.005,00 €</b></td> </tr> <tr> <td><b>2615 _ _ / _ 3</b><br/>1-10V</td> <td><b>955,00 €</b></td> </tr> <tr> <td><b>2615 _ _ / _ Z</b><br/>Casambi</td> <td><b>1.075,00 €</b></td> </tr> </table>   | <b>2615 _ _ / _ 1</b><br>DALI-2 | <b>1.005,00 €</b> | <b>2615 _ _ / _ 3</b><br>1-10V | <b>955,00 €</b> | <b>2615 _ _ / _ Z</b><br>Casambi | <b>1.075,00 €</b> |
| <b>2615 _ _ / _ 1</b><br>DALI-2   | <b>1.005,00 €</b>  |   |                                 |                   |                                |                 |                                  |                   |
| <b>2615 _ _ / _ 3</b><br>1-10V  | <b>955,00 €</b>  |   |                                 |                   |                                |                 |                                  |                   |
| <b>2615 _ _ / _ Z</b><br>Casambi  | <b>1.075,00 €</b>  |   |                                 |                   |                                |                 |                                  |                   |
| <p><b>Materials</b></p> <p>Diffuser: Polycarbonate. Main body: Aluminum.<br/>Structures: Aluminum.</p> <p><b>Light Source and electronics</b></p> <p>2 x LED PLATE 24V 6 W<br/>Constant Voltage 24V<br/>110~240V 50/60Hz</p>                                      | <p><b>Packaging</b></p> <p>2 Boxes<br/>Total Vol 0,038 m<sup>3</sup><br/>Gross weight 4,35 Kg Net weight 2,9 Kg</p> <p><b>Notes</b></p> <p>* Electrical connection point.</p>  | <p>    </p> |                                 |                   |                                |                 |                                  |                   |







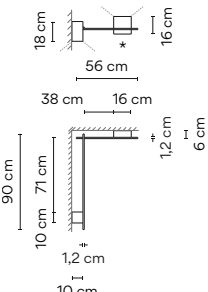

**2617**



|   |   |   |                                 |                   |                                |                 |                                  |                   |
|---|---|---|---------------------------------|-------------------|--------------------------------|-----------------|----------------------------------|-------------------|
| <p><b>Finishes</b></p> <ul style="list-style-type: none"> <li>● <b>21/ _ _ Black Grey</b><br/>(NCS S 7000-N)</li> <li>● <b>15/ _ _ Grey L2</b><br/>(NCS S 2500-N)</li> </ul> <p><b>Finish customization</b><br/>(Available options:<br/>Vibia colour palette)</p> | <p><b>LED Colour Temperature</b></p> <ul style="list-style-type: none"> <li>/1_ 2700 K  CRI &gt;90 1400 lm 117 lm/W</li> <li>/2_ 3000 K  CRI &gt;90 1513,46 lm 126 lm/W</li> <li>/3_ 3500 K  CRI &gt;90 1526,5 lm 127,2 lm/W</li> </ul> | <p><b>Control</b></p> <table border="1"> <tr> <td><b>2617 _ _ / _ 1</b><br/>DALI-2</td> <td><b>1.045,00 €</b></td> </tr> <tr> <td><b>2617 _ _ / _ 3</b><br/>1-10V</td> <td><b>995,00 €</b></td> </tr> <tr> <td><b>2617 _ _ / _ Z</b><br/>Casambi</td> <td><b>1.115,00 €</b></td> </tr> </table>   | <b>2617 _ _ / _ 1</b><br>DALI-2 | <b>1.045,00 €</b> | <b>2617 _ _ / _ 3</b><br>1-10V | <b>995,00 €</b> | <b>2617 _ _ / _ Z</b><br>Casambi | <b>1.115,00 €</b> |
| <b>2617 _ _ / _ 1</b><br>DALI-2   | <b>1.045,00 €</b>   |   |                                 |                   |                                |                 |                                  |                   |
| <b>2617 _ _ / _ 3</b><br>1-10V  | <b>995,00 €</b>   |   |                                 |                   |                                |                 |                                  |                   |
| <b>2617 _ _ / _ Z</b><br>Casambi  | <b>1.115,00 €</b>   |   |                                 |                   |                                |                 |                                  |                   |
| <p><b>Materials</b></p> <p>Diffuser: Polycarbonate. Main body: Aluminum.<br/>Structures: Aluminum.</p> <p><b>Light Source and electronics</b></p> <p>2 x LED PLATE 24V 6 W<br/>Constant Voltage 24V<br/>110~240V 50/60Hz</p>                                      | <p><b>Packaging</b></p> <p>2 Boxes<br/>Total Vol 0,041 m<sup>3</sup><br/>Gross weight 4,35 Kg Net weight 2,9 Kg</p> <p><b>Notes</b></p> <p>* Electrical connection point.</p>   | <p>    </p> |                                 |                   |                                |                 |                                  |                   |

**2620**



|   |  |  |                                 |                 |                                |                 |                                  |                 |
|---|--|--|---------------------------------|-----------------|--------------------------------|-----------------|----------------------------------|-----------------|
| <p><b>Finishes</b></p> <ul style="list-style-type: none"> <li>● <b>21/ _ _ Black Grey</b><br/>(NCS S 7000-N)</li> <li>● <b>15/ _ _ Grey L2</b><br/>(NCS S 2500-N)</li> </ul> <p><b>Finish customization</b><br/>(Available options:<br/>Vibia colour palette)</p> | <p><b>LED Colour Temperature</b></p> <ul style="list-style-type: none"> <li>/1_ 2700 K  CRI &gt;90 1400 lm 117 lm/W</li> <li>/2_ 3000 K  CRI &gt;90 1513,46 lm 126 lm/W</li> <li>/3_ 3500 K  CRI &gt;90 1526,5 lm 127,2 lm/W</li> </ul> | <p><b>Control</b></p> <table border="1"> <tr> <td><b>2620 _ _ / _ 1</b><br/>DALI-2</td> <td><b>895,00 €</b></td> </tr> <tr> <td><b>2620 _ _ / _ 3</b><br/>1-10V</td> <td><b>850,00 €</b></td> </tr> <tr> <td><b>2620 _ _ / _ Z</b><br/>Casambi</td> <td><b>970,00 €</b></td> </tr> </table>  | <b>2620 _ _ / _ 1</b><br>DALI-2 | <b>895,00 €</b> | <b>2620 _ _ / _ 3</b><br>1-10V | <b>850,00 €</b> | <b>2620 _ _ / _ Z</b><br>Casambi | <b>970,00 €</b> |
| <b>2620 _ _ / _ 1</b><br>DALI-2   | <b>895,00 €</b>  |  |                                 |                 |                                |                 |                                  |                 |
| <b>2620 _ _ / _ 3</b><br>1-10V  | <b>850,00 €</b>  |  |                                 |                 |                                |                 |                                  |                 |
| <b>2620 _ _ / _ Z</b><br>Casambi  | <b>970,00 €</b>  |  |                                 |                 |                                |                 |                                  |                 |
| <p><b>Materials</b></p> <p>Diffuser: Polycarbonate. Main body: Aluminum.<br/>Structures: Aluminum.</p> <p><b>Light Source and electronics</b></p> <p>2 x LED PLATE 24V 6 W<br/>Constant Voltage 24V<br/>110~240V 50/60Hz</p>                                      | <p><b>Packaging</b></p> <p>2 Boxes<br/>Total Vol 0,0356 m<sup>3</sup><br/>Gross weight 3,6 Kg Net weight 2,4 Kg</p> <p><b>Notes</b></p> <p>* Electrical connection point.</p>  | <p><b>UNTIL STOCK RUNS OUT</b></p> <p>    </p> |                                 |                 |                                |                 |                                  |                 |

## Ceiling

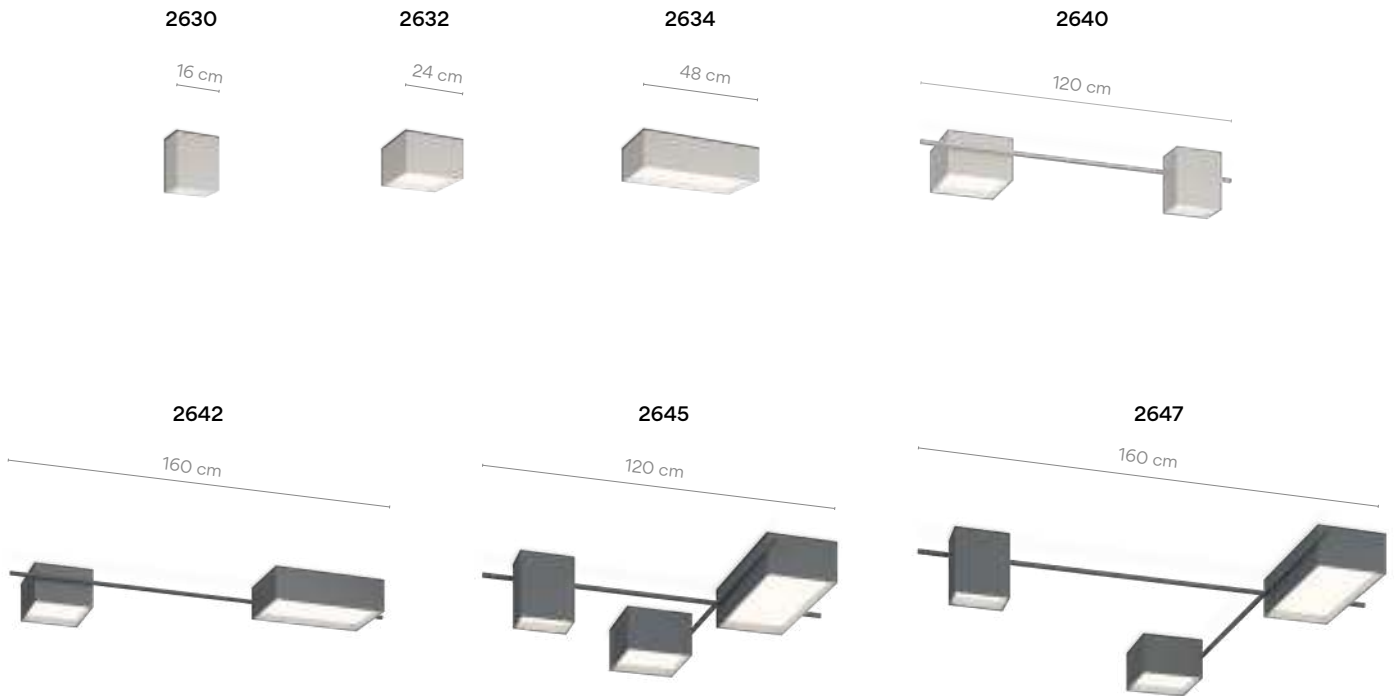

### 2630

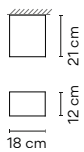

#### Finishes

- 21/ \_ \_ Black Grey (NCS S 7000-N)
- 15/ \_ \_ Grey L2 (NCS S 2500-N)

Finish customization  
 (Available options:  
 Vibia colour palette)

#### LED temperature colour

- /2 \_ 3000 K CRI >90 1078 lm 120 lm/W
- /3 \_ 3500 K CRI >90 1087,3 lm 120,8 lm/W

#### Control

|                           |          |
|---------------------------|----------|
| 2630 _ _ / _ 1<br>DALI-2  | 500,00 € |
| 2630 _ _ / _ 3<br>1-10V   | 475,00 € |
| 2630 _ _ / _ Z<br>Casambi | 595,00 € |

#### Materials

Diffuser: Polycarbonate. Main body: Aluminum.  
 Structures: Aluminum.

#### Light Source and electronics

1 x LED PLATE 24V 9 W  
 Constant Voltage 24V  
 110-240V 50/60Hz

#### Packaging

1 Box 0,4 x 0,4 x 0,2 m  
 Vol 0,032 m<sup>3</sup>  
 Gross weight 3,75 Kg Net weight 2,5 Kg



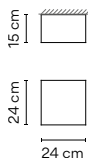

**2632**



**Finishes**

- **21/** \_\_ Black Grey (NCS S 7000-N)
- **15/** \_\_ Grey L2 (NCS S 2500-N)

**LED temperature colour**

- /2** \_ 3000 K  CRI >90 2214 lm 148 lm/W
- /3** \_ 3500 K  CRI >90 2233,1 lm 148,9 lm/W

**Control**

|  |                 |
|--|-----------------|
| <b>2632</b> __ / _ <b>1</b><br>DALI-2  | <b>800,00 €</b> |
| <b>2632</b> __ / _ <b>3</b><br>1-10V   | <b>760,00 €</b> |
| <b>2632</b> __ / _ <b>Z</b><br>Casambi | <b>880,00 €</b> |





**Finish customization**  
(Available options:  
Vibia colour palette)

---

**Materials**  
Diffuser: Polycarbonate. Main body: Aluminum.  
Structures: Aluminum.

**Light Source and electronics**  
1 x LED PLATE 24V 15 W  
Constant Voltage 24V  
110-240V 50/60Hz

**Packaging**  
1 Box 0,34 x 0,34 x 0,25 m  
Vol 0,029 m<sup>3</sup>  
Gross weight 4,35 Kg Net weight 2,9 Kg



**2634**

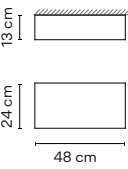

**Finishes**

- **21/** \_\_ Black Grey (NCS S 7000-N)
- **15/** \_\_ Grey L2 (NCS S 2500-N)

**LED temperature colour**

- /2** \_ 3000 K  CRI >90 4428 lm 148 lm/W
- /3** \_ 3500 K  CRI >90 4466,2 lm 148,9 lm/W

**Control**

|  |                   |
|--|-------------------|
| <b>2634</b> __ / _ <b>1</b><br>DALI-2  | <b>1.120,00 €</b> |
| <b>2634</b> __ / _ <b>3</b><br>1-10V   | <b>1.065,00 €</b> |
| <b>2634</b> __ / _ <b>Z</b><br>Casambi | <b>1.185,00 €</b> |





**Finish customization**  
(Available options:  
Vibia colour palette)

---

**Materials**  
Diffuser: Polycarbonate. Main body: Aluminum.  
Structures: Aluminum.

**Light Source and electronics**  
1 x LED PLATE 24V 30 W  
Constant Voltage 24V  
110-240V 50/60Hz

**Packaging**  
1 Box 0,58 x 0,34 x 0,23 m  
Vol 0,045 m<sup>3</sup>  
Gross weight 5,85 Kg Net weight 3,9 Kg



**2640**

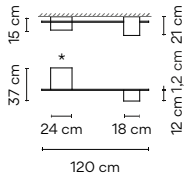

**Finishes**

- **21/** \_\_ Black Grey (NCS S 7000-N)
- **15/** \_\_ Grey L2 (NCS S 2500-N)

**LED temperature colour**

- /2** \_ 3000 K  CRI >90 3292 lm 137 lm/W
- /3** \_ 3500 K  CRI >90 3320,4 lm 138,3 lm/W

**Control**

|  |                   |
|--|-------------------|
| <b>2640</b> __ / _ <b>1</b><br>DALI-2  | <b>1.335,00 €</b> |
| <b>2640</b> __ / _ <b>3</b><br>1-10V   | <b>1.270,00 €</b> |
| <b>2640</b> __ / _ <b>Z</b><br>Casambi | <b>1.390,00 €</b> |

**Finish customization**  
(Available options:  
Vibia colour palette)





---

**Materials**  
Diffuser: Polycarbonate. Main body: Aluminum.  
Structures: Aluminum.

**Light Source and electronics**  
1 x LED PLATE 24V 9 W  
1 x LED PLATE 24V 15 W  
Constant Voltage 24V  
110-240V 50/60Hz

**Packaging**  
3 Boxes  
Total Vol 0,15 m<sup>3</sup>  
Gross weight 8,25 Kg Net weight 5,5 Kg

**Notes**  
\* Electrical connection point.

2642

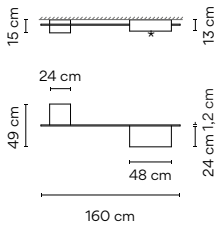

|  |   |   |  |
|--|---|---|--|
| <b>Finishes</b><br>● 21/ _ _ Black Grey (NCS S 7000-N)<br>● 15/ _ _ Grey L2 (NCS S 2500-N) | <b>LED temperature colour</b><br>/2 3000 K  CRI >90 6642 lm 148 lm/W<br>/3 3500 K  CRI >90 6699,3 lm 148,9 lm/W | <b>Control</b><br>2642 _ _ / _ 1 DALI-2<br>2642 _ _ / _ 3 1-10V<br>2642 _ _ / _ Z Casambi | 2.045,00 €<br>1.945,00 €<br>2.065,00 € |
|  |   |   |  |

**Materials**  
 Diffuser: Polycarbonate. Main body: Aluminum. Structures: Aluminum.

**Light Source and electronics**  
 1 x LED PLATE 24V 15 W  
 1 x LED PLATE 24V 30 W  
 Constant Voltage 24V  
 110-240V 50/60Hz

**Packaging**  
 1 Box 0,25 x 0,60 x 1,7 m  
 Vol 0,255 m<sup>3</sup>  
 Gross weight 11,25 Kg Net weight 7,5 Kg

**Notes**  
 \* Electrical connection point.

LED IP20 CE EAC Bi-volt

2645

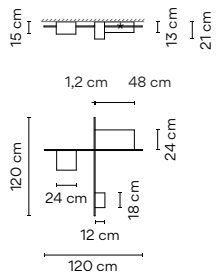

|  |  |   |  |
|--|--|---|--|
| <b>Finishes</b><br>● 21/ _ _ Black Grey (NCS S 7000-N)<br>● 15/ _ _ Grey L2 (NCS S 2500-N) | <b>LED temperature colour</b><br>/2 3000 K  CRI >90 7720 lm 143 lm/W<br>/3 3500 K  CRI >90 7786,6 lm 144,2lm/W | <b>Control</b><br>2645 _ _ / _ 1 DALI-2<br>2645 _ _ / _ 3 1-10V<br>2645 _ _ / _ Z Casambi | 2.605,00 €<br>2.480,00 €<br>2.600,00 € |
|  |  |   |  |

**Materials**  
 Diffuser: Polycarbonate. Main body: Aluminum. Structures: Aluminum.

**Light Source and electronics**  
 1 x LED PLATE 24V 9 W  
 1 x LED PLATE 24V 15 W  
 1 x LED PLATE 24V 30 W  
 Constant Voltage 24V  
 110-240V 50/60Hz

**Packaging**  
 1 Box 0,25 x 1,2 x 1,2 m  
 Vol 0,42 m<sup>3</sup>  
 Gross weight 14,25 Kg Net weight 9,25 Kg

**Notes**  
 \* Electrical connection point.

LED IP20 CE EAC Bi-volt

2647

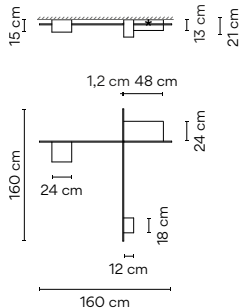

|  |   |   |  |
|--|---|---|--|
| <b>Finishes</b><br>● 21/ _ _ Black Grey (NCS S 7000-N)<br>● 15/ _ _ Grey L2 (NCS S 2500-N) | <b>LED temperature colour</b><br>/2 3000 K  CRI >90 7720 lm 143 lm/W<br>/3 3500 K  CRI >90 7786,6 lm 144,2 lm/W | <b>Control</b><br>2647 _ _ / _ 1 DALI-2<br>2647 _ _ / _ 3 1-10V<br>2647 _ _ / _ Z Casambi | 2.675,00 €<br>2.545,00 €<br>2.665,00 € |
|  |   |   |  |

**Materials**  
 Diffuser: Polycarbonate. Main body: Aluminum. Structures: Aluminum.

**Light Source and electronics**  
 1 x LED PLATE 24V 9 W  
 1 x LED PLATE 24V 15 W  
 1 x LED PLATE 24V 30 W  
 Constant Voltage 24V  
 110-240V 50/60Hz

**Packaging**  
 1 Box 0,25 x 1,7 x 1,7 m  
 Vol 0,72 m<sup>3</sup>  
 Gross weight 15,3 Kg Net weight 10,2 Kg

**Notes**  
 \* Electrical connection point.

LED IP20 CE EAC Bi-volt

# Class

Design by Sebastian Herkner

Timeless, elegant and enduring, Class brings the refined, intimate aesthetic of a patio light with the functional performance of a bollard. Rather than silently integrating into the garden environment, it stands handsome and proud, its cylindrical glass luminaire radiating with a soft, diffuse and indirect light.

## Outdoor

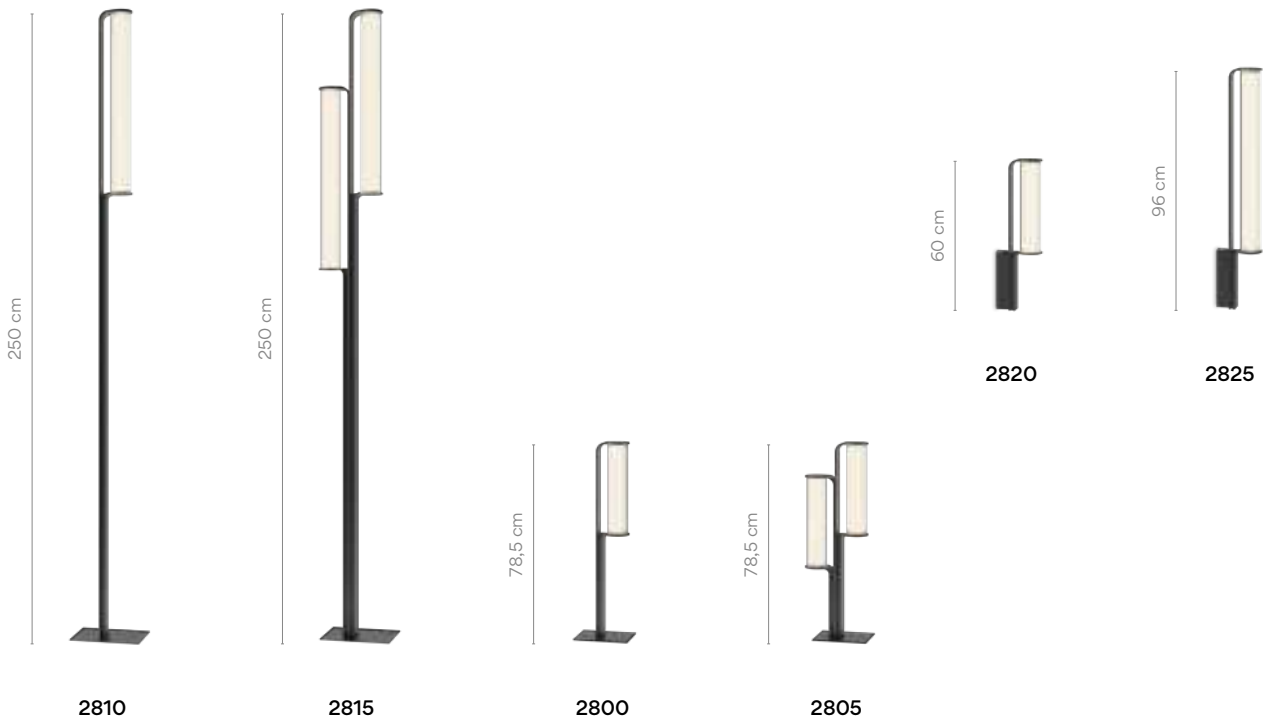

### 2800

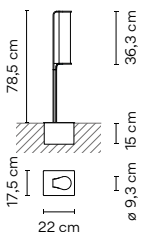

**Finishes**  
 ● 11/ \_ \_ Black  
 (NCS S 8500-N)

**LED temperature colour**  
 /1 \_ 2700 K   
 CRI >90 1188 lm 198 lm/W

| <b>Control</b>                          |            |
|---|------------|
| 2800 _ _ / _ 1<br>DALI                  | 1.315,00 € |
| 2800 _ _ / _ 5<br>Push                  | 1.250,00 € |
| 2800 _ _ / _ Z _ 30<br>Casambi (Remote) | 1.370,00 € |

**Materials**  
 Body: Aluminium. Glass: Borosilicate glass.  
 Diffuser: Opal polycarbonate.

**Light Source and electronics**  
 1 x LED 3,5W 150 mA  
 Constant Current 150 mA  
 220~240V. 50/60Hz

**Packaging**  
 2 Boxes  
 Box 1: 0,95 x 0,30 x 0,30 m  
 Box 2: 0,31 x 0,31 x 0,21 m  
 Total Vol 0,11 m<sup>3</sup>  
 Gross weight 11,6 Kg Net weight 9,6 Kg

2805

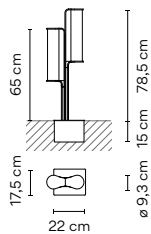

Finishes ● 11/ \_\_ Black (NCS S 8500-N)  
 LED temperature colour /1\_ 2700 K CRI >90 2376 lm 198 lm/W

Control  
 2805 \_\_ / \_ 1 DALI 2.095,00 €  
 2805 \_\_ / \_ 5 Push 1.995,00 €  
 2805 \_\_ / \_ Z Casambi (Remote) 2.115,00 €

Materials  
 Body: Aluminium. Glass: Borosilicate glass.  
 Diffuser: Opal polycarbonate.  
 Light Source and electronics  
 2 x LED 3,5W 150 mA  
 Constant Current 300 mA  
 220~240V. 50/60Hz

Packaging  
 2 Boxes  
 Box 1: 0,95 x 0,30 x 0,30 m  
 Box 2: 0,31 x 0,31 x 0,21 m  
 Total Vol 0,11 m<sup>3</sup>  
 Gross weight 14,8 Kg Net weight 12,8 Kg

2810

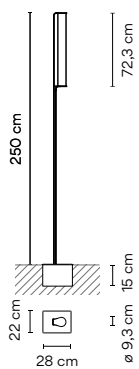

Finishes ● 11/ \_\_ Black (NCS S 8500-N)  
 LED temperature colour /1\_ 2700 K CRI >90 2376 lm 198 lm/W

Control  
 2810 \_\_ / \_ 1 DALI 1.815,00 €  
 2810 \_\_ / \_ 5 Push 1.725,00 €  
 2810 \_\_ / \_ Z 30 Casambi (Remote) 1.845,00 €

Materials  
 Body: Aluminium. Glass: Borosilicate glass.  
 Diffuser: Opal polycarbonate.  
 Light Source and electronics  
 1 x LED 7W 300 mA  
 Constant Current 300 mA  
 220~240V. 50/60Hz

Packaging  
 2 Boxes  
 Box 1: 2,92 x 0,32 x 0,32 m  
 Box 2: 0,37 x 0,32 x 0,22 m  
 Total Vol 0,33 m<sup>3</sup>  
 Gross weight 20,5 Kg Net weight 17,5 Kg

2815

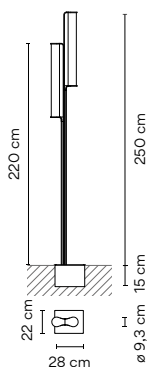

Finishes ● 11/ \_\_ Black (NCS S 8500-N)  
 LED temperature colour /1\_ 2700 K CRI >90 4752 lm 198 lm/W

Control  
 2815 \_\_ / \_ 1 DALI 3.040,00 €  
 2815 \_\_ / \_ 5 Push 2.895,00 €  
 2815 \_\_ / \_ Z 30 Casambi (Remote) 3.015,00 €

Materials  
 Body: Aluminium. Glass: Borosilicate glass.  
 Diffuser: Opal polycarbonate.  
 Light Source and electronics  
 2 x LED 7W 300 mA  
 Constant Current 600 mA  
 220~240V. 50/60Hz

Packaging  
 2 Boxes  
 Box 1: 2,92 x 0,32 x 0,32 m  
 Box 2: 0,37 x 0,32 x 0,22 m  
 Total Vol 0,33 m<sup>3</sup>  
 Gross weight 28,4 Kg Net weight 25,4 Kg

|             |  |   |   |
|-------------|--|---|---|
| <b>2820</b> | <b>Finishes</b>                          | <b>LED temperature colour</b>   | <b>Control</b>  |
|             | ● <b>11/ _ _ Black</b><br>(NCS S 8500-N) | <b>/1_ 2700 K</b> <br>CRI >90 1188 lm 198 lm/W | <b>2820 _ _ / _ 1</b> <b>995,00 €</b><br>DALI-2               |
|             |  |   | <b>2820 _ _ / _ 5</b> <b>945,00 €</b><br>Push                 |
|             |  |   | <b>2820 _ _ / Z_ 30</b> <b>1.065,00 €</b><br>Casambi (Remote) |

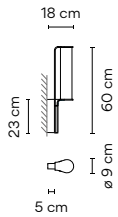
**Materials**

Body: Aluminium. Glass: Borosilicate glass.  
Diffuser: Opal polycarbonate.

**Light Source and electronics**

1 x LED 3,5W 150 mA  
Constant Current 150 mA  
220~240V. 50/60Hz

**Packaging**

1 Box 0,95 x 0,40 x 0,20 m  
Vol 0,08 m<sup>3</sup>  
Gross weight 4,4 Kg Net weight 2,9 Kg

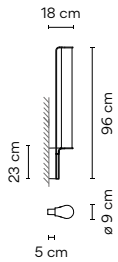

|             |  |   |   |
|-------------|--|---|---|
| <b>2825</b> | <b>Finishes</b>                          | <b>LED temperature colour</b>   | <b>Control</b>  |
|             | ● <b>11/ _ _ Black</b><br>(NCS S 8500-N) | <b>/1_ 2700 K</b> <br>CRI >90 2376 lm 198 lm/W | <b>2825 _ _ / _ 1</b> <b>1.195,00 €</b><br>DALI-2             |
|             |  |   | <b>2825 _ _ / _ 5</b> <b>1.135,00 €</b><br>Push               |
|             |  |   | <b>2825 _ _ / Z_ 30</b> <b>1.255,00 €</b><br>Casambi (Remote) |

**Materials**

Body: Aluminium. Glass: Borosilicate glass.  
Diffuser: Opal polycarbonate.

**Light Source and electronics**

1 x LED 7W 300 mA  
Constant Current 300 mA  
220~240V. 50/60Hz

**Packaging**

1 Box 0,95 x 0,30 x 0,30 m  
Vol 0,09 m<sup>3</sup>  
Gross weight 6,4 Kg Net weight 4,40 Kg







# Dama

Design by Ludovica+Roberto Palomba

Combining technical quality and refinement with a layer of warmth and intimacy, the Dama collection connects the charm of tradition with the finesse of contemporary lighting design.

## Table Floor Pendants



### 3225

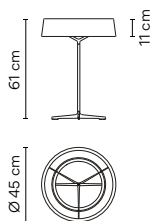

- Finishes**
- 11/ \_ \_ Black (NCS S 8500-N)
  - 25/ \_ \_ Beige D1 (NCS S 4005-Y50R)

**LED temperature colour**

/1 \_ 2700 K CRI >90 1850 lm 120 lm/W

| Control                   |          |
|---------------------------|----------|
| 3225 _ _ / _ 5<br>Push    | 825,00 € |
| 3225 _ _ / _ Z<br>Casambi | 945,00 € |

**Materials**

Tube: Steel. Base: Zamak.  
Shade: Paper.

**Light Source and electronics**

1 x LED STRIP 16,2W 900 mA  
Constant Voltage 24V  
100~240V. 50/60Hz

**Packaging**

1 Box 0,75 x 0,55 x 0,55 m  
Vol 0,23 m<sup>3</sup>  
Gross weight 3,3 Kg Net weight 1,8 Kg

**Notes**

Electric cable 2,5 m

LED IP20 Bi-volt

1160 10 /1A \_18

Model  
Finish  
LED temperature colour  
Control  
Electrical connection  
Only for pendants

3230

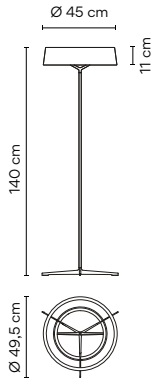

- Finishes
- 11/ \_ \_ Black (NCS S 8500-N)
  - 25/ \_ \_ Beige D1 (NCS S 4005-Y50R)

LED temperature colour  
/1 \_ 2700 K   
CRI >90 1850 lm 120 lm/W

| Control                   | Price      |
|---------------------------|------------|
| 3230 _ _ / _ 5<br>Push    | 895,00 €   |
| 3230 _ _ / _ Z<br>Casambi | 1.015,00 € |

Materials

Tube: Steel. Base: Zamak.  
Shade: Paper.

Light Source and electronics  
1 x LED STRIP 16,2W 900 mA  
Constant Voltage 24V  
100-240V. 50/60Hz

Packaging

1 Box 1,6 x 0,55 x 0,55 m  
Vol 0,48 m<sup>3</sup>  
Gross weight 5 Kg Net weight 2,55 Kg

Notes

Electric cable 2,5 m

3235

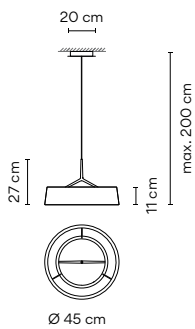

- Finishes
- 11/ \_ \_ Black (NCS S 8500-N)
  - 25/ \_ \_ Beige D1 (NCS S 4005-Y50R)

LED temperature colour  
/1 \_ 2700 K   
CRI >90 1850 lm 120 lm/W

| Control                       | Price    |
|-------------------------------|----------|
| 3235 _ _ / _ 1<br>DALI        | 790,00 € |
| 3235 _ _ / _ B<br>1-10V, Push | 750,00 € |
| 3235 _ _ / _ Z<br>Casambi     | 870,00 € |

Materials

Body: Aluminium.  
Shade: Paper.

Light Source and electronics  
1 x LED STRIP 16,2W 900 mA  
Constant Current 900 mA  
110-240V. 50/60Hz

Packaging

1 Box 0,40 x 0,55 x 0,55 m  
Vol 0,12 m<sup>3</sup>  
Gross weight 3,2 Kg Net weight 1,6 Kg

Notes

Extra cable length. 16,00 €/m

Electrical connection  
\_18 Surface Free Wire  
\_23 Built-in  
\_31 Remote Micro for plaster ceilings  
\_32 Remote XXS for all types of drop ceilings



# Electrical connection options for model 3235

Choose your preferred installation option according to your needs. For each composition, the optimal minimum number of drivers will be delivered.

## Drop ceiling

The innovative remote and built-in fittings accentuate the silkiness and lightness of compositions on suspended ceilings, its great visual grandeur taking center stage.

For Ref. 3235

### Remote

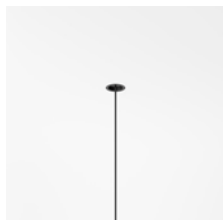

**Micro**  $\varnothing$  3 cm  
height 7 cm  
for plaster ceilings.  
Black finish.

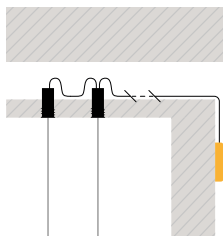

### Built-in



**XXS**  $\varnothing$  6 cm  
height 6 cm  
match with  
fixture finish.

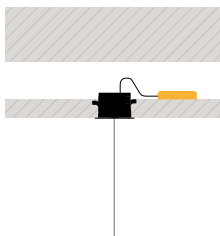

## Regular ceiling

When architecture does not allow for performance, surface and free wire showcase possibilities for any need or desire with no limits, ideal for both individual or cluster arrangements.

For Ref. 3235

### Surface



ø 20 cm  
match with  
fixture finish.

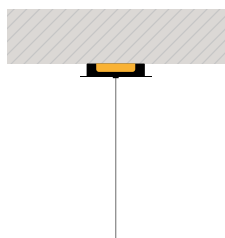

### Free Wire



1 wire

ø 20 cm



2 wires

ø 22 cm



3 - 6 wires

ø 36 cm



7 - 8 wires

ø 40 cm

you can choose the finish of the canopy  
among black, white or any colour  
matching one of the pendants.

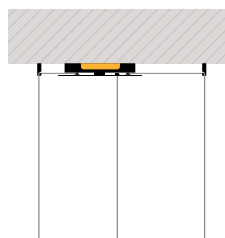

# Palma

Design by Antoni Arola

The interior ambience takes on a life of its own with the possibility of integrating plants with the lighting compositions. Palma connects light and vegetation as in the natural landscape.

## Wall



|             |   |  |  |                 |
|-------------|---|--|--|-----------------|
| <b>3700</b> | <b>Finishes</b><br>● <b>18/</b> __ Graphite<br>(ADAPTA RF 9913 WX)<br>● <b>93/</b> __ White<br>(RAL 9016) | <b>LED temperature colour</b><br>/1_ 2700 K<br>CRI >90 868 lm 94 lm/W                                      | <b>Control</b><br><b>3700</b> __ / __ B<br>1-10V, Push   | <b>615,00 €</b> |
|             | <b>Materials</b><br>Diffuser: Blown-glass. Profile: Aluminum.   | <b>Light Source and electronics</b><br>2 x LED 4,6 W 500 mA<br>Constant Current 500 mA<br>220~240V 50/60Hz | <b>Packaging</b><br>1 Box 0,57 x 0,31 x 0,21 m<br>Vol 0,0382 m <sup>3</sup><br>Gross weight 3 Kg Net weight 1,8 Kg |                 |

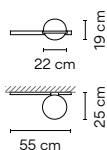

3702

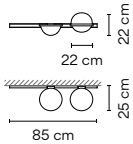

|  |                                      |
|--|--------------------------------------|
| <b>Finishes</b>                                  | <b>LED temperature colour</b>        |
| ● <b>18/ _ _ Graphite</b><br>(ADAPTA RF 9913 WX) | /1_ 2700 K<br>CRI >90 868 lm 87 lm/W |
| ● <b>93/ _ _ White</b><br>(RAL 9016)             |                                      |

|                                      |                 |
|--------------------------------------|-----------------|
| <b>Control</b>                       |                 |
| <b>3702 _ _ / _ 1</b><br>DALI        | <b>925,00 €</b> |
| <b>3702 _ _ / _ B</b><br>1-10V, Push | <b>880,00 €</b> |

**Materials**  
 Diffuser: Blown-glass. Profile: Aluminum.  
 Planter: PMMA.

**Light Source and electronics**  
 2 x LED 4,6 W 500 mA  
 Constant Current 500 mA  
 220~240V 50/60Hz

**Packaging**  
 1 Box 0,87 x 0,31 x 0,21 m  
 Vol 0,0581 m<sup>3</sup>  
 Gross weight 4,05 Kg Net weight 2,4 Kg

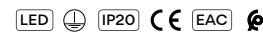

3704

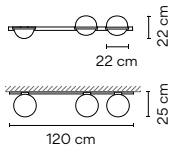

|  |                                       |
|--|---------------------------------------|
| <b>Finishes</b>                                  | <b>LED temperature colour</b>         |
| ● <b>18/ _ _ Graphite</b><br>(ADAPTA RF 9913 WX) | /1_ 2700 K<br>CRI >90 1736 lm 87 lm/W |
| ● <b>93/ _ _ White</b><br>(RAL 9016)             |                                       |

|                                      |                   |
|--------------------------------------|-------------------|
| <b>Control</b>                       |                   |
| <b>3704 _ _ / _ 1</b><br>DALI        | <b>1.220,00 €</b> |
| <b>3704 _ _ / _ B</b><br>1-10V, Push | <b>1.160,00 €</b> |

**Materials**  
 Diffuser: Blown-glass. Profile: Aluminum.  
 Planter: PMMA.

**Light Source and electronics**  
 4 x LED 4,6 W 500 mA  
 Constant Current 500 mA  
 220~240V 50/60Hz

**Packaging**  
 2 Boxes  
 Total Vol 0,0081 m<sup>3</sup>  
 Gross weight 6,2 Kg Net weight 3,9 Kg

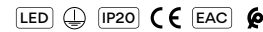

3706

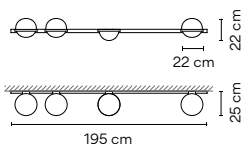

|  |                                       |
|--|---------------------------------------|
| <b>Finishes</b>                                  | <b>LED temperature colour</b>         |
| ● <b>18/ _ _ Graphite</b><br>(ADAPTA RF 9913 WX) | /1_ 2700 K<br>CRI >90 2604 lm 87 lm/W |
| ● <b>93/ _ _ White</b><br>(RAL 9016)             |                                       |

|                                      |                   |
|--------------------------------------|-------------------|
| <b>Control</b>                       |                   |
| <b>3706 _ _ / _ 1</b><br>DALI        | <b>1.775,00 €</b> |
| <b>3706 _ _ / _ B</b><br>1-10V, Push | <b>1.690,00 €</b> |

**Materials**  
 Diffuser: Blown-glass. Profile: Aluminum.  
 Planter: PMMA.

**Light Source and electronics**  
 6 x LED 4,6 W 500 mA  
 Constant Current 500 mA  
 220~240V 50/60Hz

**Packaging**  
 2 Boxes  
 Total Vol 0,1793 m<sup>3</sup>  
 Gross weight 6,4 Kg Net weight 3,9 Kg

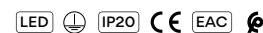

3710

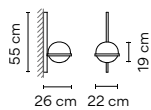

|  |                                      |
|--|--------------------------------------|
| <b>Finishes</b>                                  | <b>LED temperature colour</b>        |
| ● <b>18/ _ _ Graphite</b><br>(ADAPTA RF 9913 WX) | /1_ 2700 K<br>CRI >90 868 lm 87 lm/W |
| ● <b>93/ _ _ White</b><br>(RAL 9016)             |                                      |

|                                      |                 |
|--------------------------------------|-----------------|
| <b>Control</b>                       |                 |
| <b>3710 _ _ / _ B</b><br>1-10V, Push | <b>650,00 €</b> |

**Materials**  
 Diffuser: Blown-glass. Profile: Aluminum.

**Light Source and electronics**  
 2 x LED 4,6 W 500 mA  
 Constant Current 500 mA  
 220~240V 50/60Hz

**Packaging**  
 1 Box 0,57 x 0,31 x 0,21 m  
 Vol 0,0382 m<sup>3</sup>  
 Gross weight 2,6 Kg Net weight 1,8 Kg

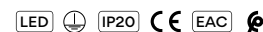

**3714**



|   |  |  |
|---|--|--|
| <b>Finishes</b>                                 | <b>LED temperature colour</b>  | <b>Control</b>   |
| ● <b>18/</b> __ Graphite<br>(ADAPTA RF 9913 WX) | <b>/1</b> _ 2700 K  | <b>3714</b> __ / _ <b>1</b> <span style="float: right;"><b>945,00 €</b></span> |
| ● <b>93/</b> __ White<br>(RAL 9016)             | CRI >90 868 lm 87 lm/W   | DALI   |
|   |  | <b>3714</b> __ / _ <b>B</b> <span style="float: right;"><b>900,00 €</b></span> |
|   |  | 1-10V, Push  |

---

|   |   |
|---|---|
| <b>Materials</b>  | <b>Packaging</b>  |
| Diffuser: Blown-glass. Profile: Aluminum.<br>Planter: PMMA. | 2 Boxes<br>Total Vol 0,0081 m <sup>3</sup><br>Gross weight 5,2 Kg Net weight 2,9 Kg |

**Light Source and electronics**  
2 x LED 4,6 W 500 mA  
Constant Current 500 mA  
220~240V 50/60Hz

**LED**     

**3716**



|   |  |  |
|---|--|--|
| <b>Finishes</b>                                 | <b>LED temperature colour</b>  | <b>Control</b>   |
| ● <b>18/</b> __ Graphite<br>(ADAPTA RF 9913 WX) | <b>/1</b> _ 2700 K  | <b>3716</b> __ / _ <b>1</b> <span style="float: right;"><b>1.150,00 €</b></span> |
| ● <b>93/</b> __ White<br>(RAL 9016)             | CRI >90 1736 lm 87 lm/W  | DALI   |
|   |  | <b>3716</b> __ / _ <b>B</b> <span style="float: right;"><b>1.095,00 €</b></span> |
|   |  | 1-10V, Push  |

---

|   |   |
|---|---|
| <b>Materials</b>                          | <b>Packaging</b>  |
| Diffuser: Blown-glass. Profile: Aluminum. | 2 Boxes<br>Total Vol 0,0081 m <sup>3</sup><br>Gross weight 6,5 Kg Net weight 4,2 Kg |

**Light Source and electronics**  
4 x LED 4,6 W 500 mA  
Constant Current 500 mA  
220~240V 50/60Hz

**LED**     

**3718**

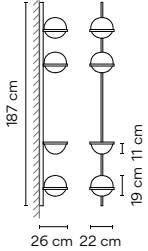





|   |  |  |
|---|--|--|
| <b>Finishes</b>                                 | <b>LED temperature colour</b>  | <b>Control</b>   |
| ● <b>18/</b> __ Graphite<br>(ADAPTA RF 9913 WX) | <b>/1</b> _ 2700 K  | <b>3718</b> __ / _ <b>1</b> <span style="float: right;"><b>1.880,00 €</b></span> |
| ● <b>93/</b> __ White<br>(RAL 9016)             | CRI >90 2604 lm 87 lm/W  | DALI   |
|   |  | <b>3718</b> __ / _ <b>B</b> <span style="float: right;"><b>1.790,00 €</b></span> |
|   |  | 1-10V, Push  |

---

|   |   |
|---|---|
| <b>Materials</b>  | <b>Packaging</b>  |
| Diffuser: Blown-glass. Profile: Aluminum.<br>Planter: PMMA. | 2 Boxes<br>Total Vol 0,1793 m <sup>3</sup><br>Gross weight 8,6 Kg Net weight 6,1 Kg |

**Light Source and electronics**  
6 x LED 4,6 W 500 mA  
Constant Current 500 mA  
220~240V 50/60Hz

**LED**     



Pendants



3720

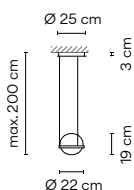

Finishes  
 ● 18/ \_ \_ Graphite (ADAPTA RF 9913 WX)  
 ● 93/ \_ \_ White (RAL 9016)

LED temperature colour  
 /1\_ 2700 K   
 CRI >90 868 lm 87 lm/W

Control  
 3720 \_ \_ / \_ 1 730,00 €  
 DALI  
 3720 \_ \_ / \_ B 695,00 €  
 1-10V, Push  
 3720 \_ \_ / \_ Z 815,00 €  
 Casambi

Materials  
 Diffuser: Blown-glass. Profile: Aluminum.

Light Source and electronics  
 2 x LED 4,6 W 500 mA  
 Constant Current 500 mA  
 110-240V 50/60Hz

Packaging  
 1 Box 0,71 x 0,27 x 0,21 m  
 Vol 0,0413 m<sup>3</sup>  
 Gross weight 3,75 Kg Net weight 2,8 Kg

Notes  
 Extra cable length. 16,00 €/m



3724

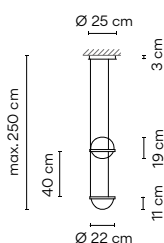

Finishes  
 ● 18/ \_ \_ Graphite (ADAPTA RF 9913 WX)  
 ● 93/ \_ \_ White (RAL 9016)

LED temperature colour  
 /1\_ 2700 K   
 CRI >90 868 lm 87 lm/W

Control  
 3724 \_ \_ / \_ 1 990,00 €  
 DALI  
 3724 \_ \_ / \_ B 940,00 €  
 1-10V, Push  
 3724 \_ \_ / \_ Z 1.060,00 €  
 Casambi

Materials  
 Diffuser: Blown-glass. Profile: Aluminum.  
 Planter: PMMA.

Light Source and electronics  
 2 x LED 4,6 W 500 mA  
 Constant Current 500 mA  
 110-240V 50/60Hz

Packaging  
 1 Box 1,02 x 0,27 x 0,21 m  
 Vol 0,0588 m<sup>3</sup>  
 Gross weight 4,6 Kg Net weight 3,3 Kg

Notes  
 Extra cable length. 16,00 €/m



3726

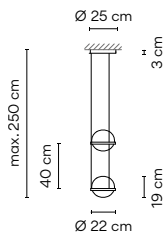

Finishes  
 ● 18/ \_ \_ Graphite (ADAPTA RF 9913 WX)  
 ● 93/ \_ \_ White (RAL 9016)

LED temperature colour  
 /1\_ 2700 K   
 CRI >90 1736 lm 87 lm/W

Control  
 3726 \_ \_ / \_ 1 1.210,00 €  
 DALI  
 3726 \_ \_ / \_ B 1.150,00 €  
 1-10V, Push  
 3726 \_ \_ / \_ Z 1.270,00 €  
 Casambi

Materials  
 Diffuser: Blown-glass. Profile: Aluminum.

Light Source and electronics  
 4 x LED 4,6 W 500 mA  
 Constant Current 500 mA  
 110-240V 50/60Hz

Packaging  
 1 Box 1,02 x 0,27 x 0,21 m  
 Vol 0,0588 m<sup>3</sup>  
 Gross weight 5,4 Kg Net weight 4,1 Kg

Notes  
 Extra cable length. 16,00 €/m



3728

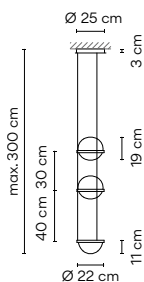

Finishes  
 ● 18/ \_ \_ Graphite (ADAPTA RF 9913 WX)  
 ● 93/ \_ \_ White (RAL 9016)

LED temperature colour  
 /1\_ 2700 K   
 CRI >90 1736 lm 87 lm/W

Control  
 3728 \_ \_ / \_ 1 1.450,00 €  
 DALI  
 3728 \_ \_ / \_ B 1.380,00 €  
 1-10V, Push  
 3728 \_ \_ / \_ Z 1.500,00 €  
 Casambi

Materials  
 Diffuser: Blown-glass. Profile: Aluminum.  
 Planter: PMMA.

Light Source and electronics  
 4 x LED 4,6 W 500 mA  
 Constant Current 500 mA  
 110-240V 50/60Hz

Packaging  
 1 Box 0,75 x 0,53 x 0,21 m  
 Vol 0,0857 m<sup>3</sup>  
 Gross weight 8,8 Kg Net weight 4,7 Kg

Notes  
 Extra cable length. 16,00 €/m



3730

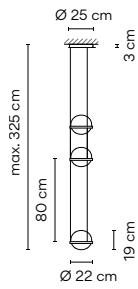

|  |                                     |
|--|-------------------------------------|
| <b>Finishes</b>                        | <b>LED temperature colour</b>       |
| ● 18/ _ _ Graphite (ADAPTA RF 9913 WX) | /1_ 2700 K  CRI >90 2604 lm 87 lm/W |
| ● 93/ _ _ White (RAL 9016)             |                                     |

|                   |            |
|-------------------|------------|
| <b>Control</b>    |            |
| 3730 _ _ / _ A    | 1.695,00 € |
| DALI, 1-10V, Push |            |
| 3730 _ _ / _ Z    | 1.815,00 € |
| Casambi           |            |

**Materials**  
 Diffuser: Blown-glass. Profile: Aluminum.

**Light Source and electronics**  
 6 x LED 4,6 W 500 mA  
 Constant Current 500 mA  
 110-240V 50/60Hz

**Packaging**  
 1 Box 0,75 x 0,53 x 0,21 m  
 Vol 0,0857 m<sup>3</sup>  
 Gross weight 9,5 Kg Net weight 5,4 Kg

**Notes**  
 Extra cable length. 16,00 €/m



3734

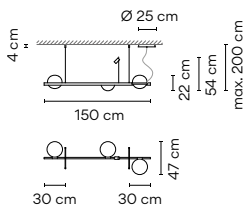

|  |                                      |
|--|--------------------------------------|
| <b>Finishes</b>                        | <b>LED temperature colour</b>        |
| ● 18/ _ _ Graphite (ADAPTA RF 9913 WX) | /1_ 2700 K  CRI >90 2265 lm 103 lm/W |
| ● 93/ _ _ White (RAL 9016)             |                                      |

|                   |            |
|-------------------|------------|
| <b>Control</b>    |            |
| 3734 _ _ / _ A    | 1.825,00 € |
| DALI, 1-10V, Push |            |
| 3734 _ _ / _ Z    | 1.945,00 € |
| Casambi           |            |

**Materials**  
 Diffuser: Blown-glass. Profile: Aluminum.  
 Planter: PMMA.

**Light Source and electronics**  
 1 x LED 2 W 500 mA  
 4 x LED 4,6 W 500 mA  
 Constant Current 500 mA  
 110-240V 50/60Hz

**Packaging**  
 1 Box 1,72 x 0,33 x 0,31 m  
 Vol 0,1790 m<sup>3</sup>  
 Gross weight 9,4 Kg Net weight 5,95 Kg

**Notes**  
 Extra cable length. 16,00 €/m



3736

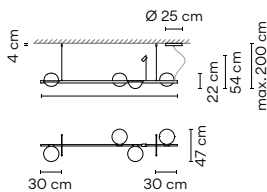

|  |                                     |
|--|-------------------------------------|
| <b>Finishes</b>                        | <b>LED temperature colour</b>       |
| ● 18/ _ _ Graphite (ADAPTA RF 9913 WX) | /1_ 2700 K  CRI >90 3133 lm 98 lm/W |
| ● 93/ _ _ White (RAL 9016)             |                                     |

|                   |            |
|-------------------|------------|
| <b>Control</b>    |            |
| 3736 _ _ / _ A    | 2.190,00 € |
| DALI, 1-10V, Push |            |
| 3736 _ _ / _ Z    | 2.310,00 € |
| Casambi           |            |

**Materials**  
 Diffuser: Blown-glass. Profile: Aluminum.  
 Planter: PMMA.

**Light Source and electronics**  
 1 x LED 2 W 500 mA  
 6 x LED 4,6 W 500 mA  
 Constant Current 500 mA  
 110-240V 50/60Hz

**Packaging**  
 2 Boxes  
 Vol 0,1793 m<sup>3</sup>  
 Gross weight 9,1 Kg Net weight 6,6 Kg

**Notes**  
 Extra cable length. 16,00 €/m

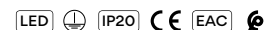

Table



ø 22 cm

3740

3740

|   |                               |                      |                 |
|---|-------------------------------|----------------------|-----------------|
| <b>Finishes</b>                                 | <b>LED temperature colour</b> | <b>Control</b>       | <b>640,00 €</b> |
| ● <b>18/ __ Graphite</b><br>(ADAPTA RF 9913 WX) | <b>/1_ 2700 K</b>             | <b>3740 __ / _ 5</b> |                 |
| ● <b>93/ __ White</b><br>(RAL 9016)             | CRI >90 868,0 lm 94 lm/W      | Push                 |                 |

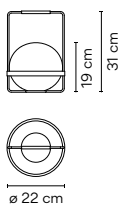

**Materials**

Diffuser: Blown-glass. Profile: Aluminum.  
Rods: Steel.

**Light Source and electronics**

2 x LED 4,6 W 500 mA  
Constant Current 500 mA  
100~240V 50/60Hz

**Packaging**

1 Box 0,24 x 0,24 x 0,49 m  
Vol 0,0282 m<sup>3</sup>  
Gross weight 1,7 Kg Net weight 1,2 Kg

**Notes**

Electric cable with plug and push-button (3m).

**UNTIL STOCK RUNS OUT**

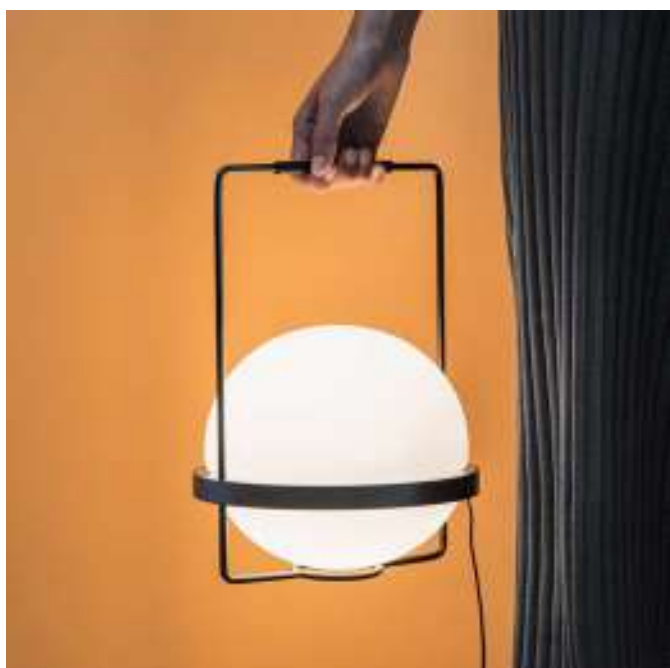



# Plis Outdoor

Design by Ramos & Bassols

A surprising design which brings the warm atmosphere and textures of the indoors to the garden, terrace or porch. Breaking down boundaries between inside and outside.

## Outdoor

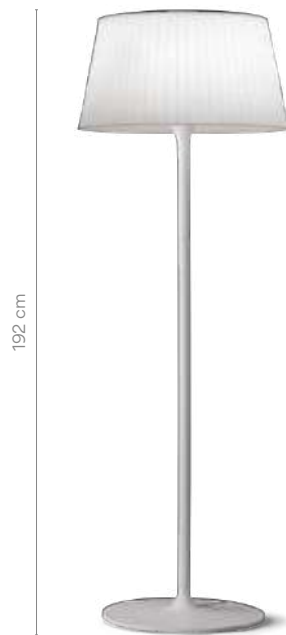

4030 4035

### 4030

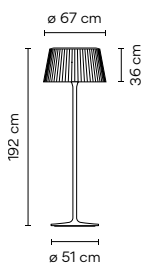

#### Finishes

- 03 White (RAL 9016)

LED 2700 K 1520 lm Dim

4030 03

1.835,00 €

#### Materials

Diffuser: Polyethylene. Base: Polyurethane foam.  
Lid: Steel.

#### Packaging

1 Box 1,99 x 0,75 x 0,76 m  
Vol 1,1430 m<sup>3</sup>  
Gross weight 40,5 Kg Net weight 29,5 Kg

#### Light Source and electronics

2 x E27 230V 12 W

#### Notes

Portable version. Surface cable 3,5 m

**UNTIL STOCK RUNS OUT**



### 4035

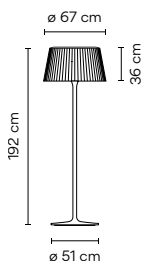

#### Finishes

- 03 White (RAL 9016)

LED 2700 K 1520 lm Dim

4035 03

1.990,00 €

#### Materials

Diffuser: Polyethylene. Base: Polyurethane foam.  
Lid: Steel.

#### Packaging

1 Box 1,99 x 0,75 x 0,76 m  
Vol 1,1430 m<sup>3</sup>  
Gross weight 40,5 Kg Net weight 29,5 Kg

#### Light Source and electronics

2 x E27 230V 12 W

#### Notes

Built-in cable.

**UNTIL STOCK RUNS OUT**



1160 10 /1A  
Model Finish  
LED temperature colour  
Control



# Wind

Design by Jordi Vilardell

A perfect marriage of technology and tradition. Wind's drum shade is made of fibreglass, an innovative webbed texture and pattern that elevates the visual contribution of this timeless silhouette.

## Outdoor



ø 60 cm

4072



ø 60 cm

4077



ø 120 cm

4078



4057



4062



4067

4057

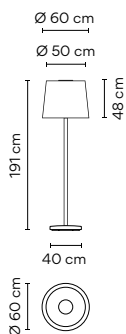

### Finishes

- 27/ \_\_ Brown L1  
(NCS S 1505-Y50R)
- 53/ \_\_ Green M1  
(NCS S 6005-G80Y)
- 61/ \_\_ Ocre red  
(NCS S 3050-Y60R)

### LED temperature colour

/1\_ 2700 K   
 CRI >90 3299,09 lm 132 lm/W

### Control

4057 \_\_ / \_\_ 0  
On/ Off

2.070,00 €

### Materials

Shade: Filament winding. Weight: Concrete.  
Lid: Steel. Diffuser: Methacrylate.

### Light Source and electronics

1 x LED PLATE 25 W 700 mA  
Constant Current 700 mA  
110-240V 50/60Hz

### Packaging

2 Boxes  
Total Vol 1,0300 m<sup>3</sup>  
Gross weight 45,1 Kg Net weight 27,8 Kg

### Notes

Portable version. Electric cable 1,5 m



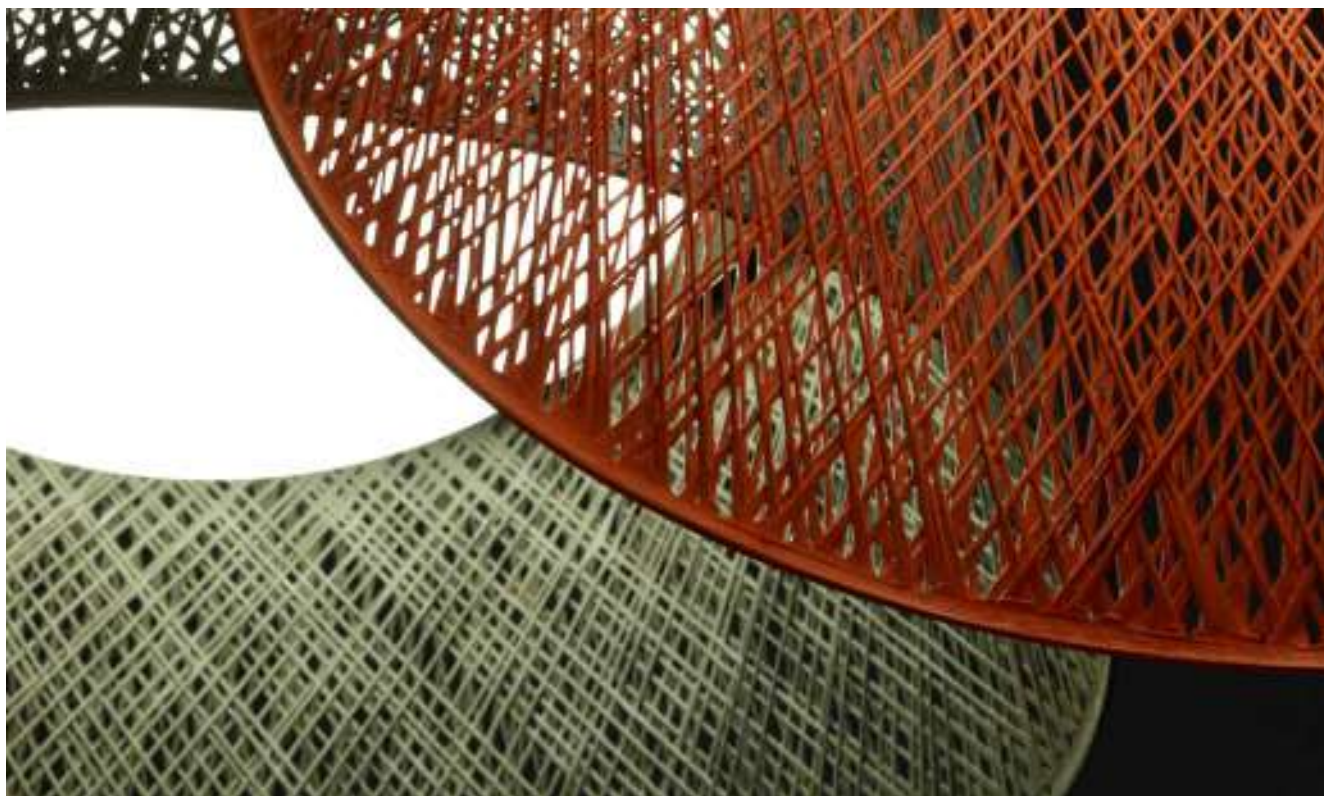

4062

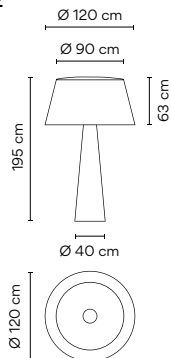

|   |   |                          |                   |
|---|---|--------------------------|-------------------|
| <b>Finishes</b>   | <b>LED temperature colour</b>             | <b>Control</b>           |                   |
| <ul style="list-style-type: none"> <li>● 27/ __ Brown L1 (NCS S 1505-Y50R)</li> <li>● 53/ __ Green M1 (NCS S 6005-G80Y)</li> <li>● 61/ __ Ocre red (NCS S 3050-Y60R)</li> </ul> | /1_ 2700 K<br>CRI >90 3481,09 lm 129 lm/W | 4062 __ / _ 0<br>On/ Off | <b>5.510,00 €</b> |

**Materials**

Base: Filament winding. Shade: Filament winding.  
 Diffuser: Methacrylate.

**Light Source and electronics**

4 x LED 14 W 500 mA  
 1 x LED 2,4 W 700 mA  
 Constant Current 700 mA  
 110-240V 50/60Hz

**Packaging**

4 Boxes  
 Total Vol 2,3500 m<sup>3</sup>  
 Gross weight 125,2 Kg Net weight 113,23 Kg

**Notes**

Portable version. Electric cable 2 m

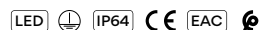

4067

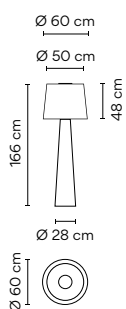

|   |   |                          |                   |
|---|---|--------------------------|-------------------|
| <b>Finishes</b>   | <b>LED temperature colour</b>             | <b>Control</b>           |                   |
| <ul style="list-style-type: none"> <li>● 27/ __ Brown L1 (NCS S 1505-Y50R)</li> <li>● 53/ __ Green M1 (NCS S 6005-G80Y)</li> <li>● 61/ __ Ocre red (NCS S 3050-Y60R)</li> </ul> | /1_ 2700 K<br>CRI >90 3481,09 lm 129 lm/W | 4067 __ / _ 0<br>On/ Off | <b>3.450,00 €</b> |

**Materials**

Shade: Filament Winding. Base: Filament Winding.  
 Diffuser: Methacrylate.

**Light Source and electronics**

1 x LED PLATE 25 W 700 mA  
 1 x LED 2,4 W 700 mA  
 Constant Current 700 mA  
 110-240V 50/60Hz

**Packaging**

3 Boxes  
 Total Vol 1,5000 m<sup>3</sup>  
 Gross weight 50 Kg Net weight 30,5 Kg

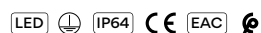

**Notes**

Portable version. Electric cable 1,5 m



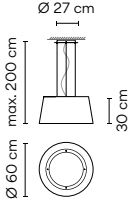



**4072**

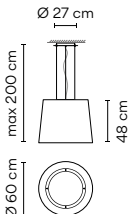

|  |  |   |                          |
|--|--|---|--------------------------|
| <p><b>Finishes</b></p> <ul style="list-style-type: none"> <li>● <b>27/</b> __ Brown L1<br/>(NCS S 1505-Y50R)</li> <li>● <b>53/</b> __ Green M1<br/>(NCS S 6005-G80Y)</li> <li>● <b>61/</b> __ Ocre red<br/>(NCS S 3050-Y60R)</li> </ul>  | <p><b>LED temperature colour</b></p> <p><b>/1</b> _ 2700 K </p> <p>CRI &gt;90 3299,09 lm 132 lm/W</p> | <p><b>Control</b></p> <p><b>4072</b> __ / _ 0<br/>On/ Off</p>   | <p><b>1.255,00 €</b></p> |
| <p><b>Materials</b></p> <p>Shade: Filament winding. Canopy Plate: Steel.<br/>Lid: Steel. Diffuser: Methacrylate.</p> <p><b>Light Source and electronics</b></p> <p>1 x LED PLATE 25 W 700 mA<br/>Constant Current 700 mA<br/>110-240V 50/60Hz</p>  |  | <p><b>Packaging</b></p> <p>1 Box 0,50 x 0,77 x 0,77 m<br/>Vol 0,2970 m<sup>3</sup><br/>Gross weight 11,1 Kg Net weight 9,9 Kg</p> <p><b>Notes</b></p> <p>Surface mounted<br/>Extra cable length. <b>16,00 €/m</b></p> |                          |
| <p><b>LED</b>  <b>IP65</b>  <b>EAC</b> </p> |  |   |                          |





**4077**

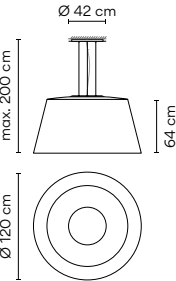

|  |  |   |                          |
|--|--|---|--------------------------|
| <p><b>Finishes</b></p> <ul style="list-style-type: none"> <li>● <b>27/</b> __ Brown L1<br/>(NCS S 1505-Y50R)</li> <li>● <b>53/</b> __ Green M1<br/>(NCS S 6005-G80Y)</li> <li>● <b>61/</b> __ Ocre red<br/>(NCS S 3050-Y60R)</li> </ul>  | <p><b>LED temperature colour</b></p> <p><b>/1</b> _ 2700 K </p> <p>CRI &gt;90 3299,09 lm 132 lm/W</p> | <p><b>Control</b></p> <p><b>4077</b> __ / _ 0<br/>On/ Off</p>   | <p><b>1.335,00 €</b></p> |
| <p><b>Materials</b></p> <p>Shade: Filament winding. Canopy Plate: Steel.<br/>Lid: Steel. Diffuser: Methacrylate.</p> <p><b>Light Source and electronics</b></p> <p>1 x LED PLATE 25 W 700 mA<br/>Constant Current 700 mA<br/>110-240V 50/60Hz</p>  |  | <p><b>Packaging</b></p> <p>1 Box 0,67 x 0,67 x 0,62 m<br/>Vol 0,2970 m<sup>3</sup><br/>Gross weight 11 Kg Net weight 9,9 Kg</p> <p><b>Notes</b></p> <p>Surface mounted<br/>Extra cable length. <b>16,00 €/m</b></p> |                          |
| <p><b>LED</b>  <b>IP65</b>  <b>EAC</b> </p> <p><b>Dimmer</b> <b>Bi-volt</b></p> |  |   |                          |

**4078**



|  |  |  |                          |
|--|--|--|--------------------------|
| <p><b>Finishes</b></p> <ul style="list-style-type: none"> <li>● <b>27/</b> __ Brown L1<br/>(NCS S 1505-Y50R)</li> <li>● <b>53/</b> __ Green M1<br/>(NCS S 6005-G80Y)</li> <li>● <b>61/</b> __ Ocre red<br/>(NCS S 3050-Y60R)</li> </ul>  | <p><b>LED temperature colour</b></p> <p><b>/1</b> _ 2700 K </p> <p>CRI &gt;90 3299,09 lm 132 lm/W</p> | <p><b>Control</b></p> <p><b>4078</b> __ / _ 0<br/>On/ Off</p>  | <p><b>2.390,00 €</b></p> |
| <p><b>Materials</b></p> <p>Shade: Filament winding. Canopy Plate: Steel.<br/>Lid: Steel. Diffuser: Methacrylate.</p> <p><b>Light Source and electronics</b></p> <p>3 x LED PLATE 25 W 700 mA<br/>Constant Current 700 mA<br/>110-240V 50/60Hz</p>  |  | <p><b>Packaging</b></p> <p>1 Box 0,74 x 1,24 x 1,27 m<br/>Vol 1,1300 m<sup>3</sup><br/>Gross weight 38 Kg Net weight 30 Kg</p> <p><b>Notes</b></p> <p>Indoor only<br/>Extra cable length. <b>16,00 €/m</b></p> |                          |
| <p><b>LED</b>  <b>IP20</b>  <b>EAC</b> </p> <p><b>Dimmer</b> <b>Bi-volt</b></p> |  |  |                          |



# Break

Design by Xuclà & Alemany

Resembling an avant-garde sculpture, Break is distinguished by its architectural attitude. The cubic volumes angle provides down light, while doubling as sculptural outdoor presence.

## Outdoor

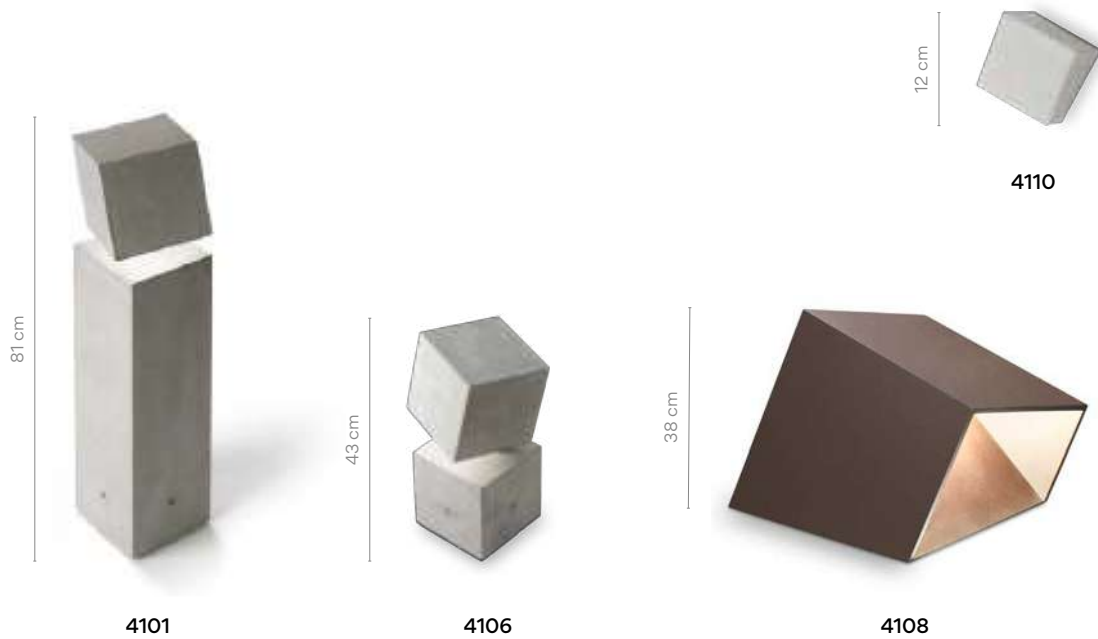

|                 |  |  |   |          |
|-----------------|--|--|---|----------|
| <b>4101</b><br> | <b>Finishes</b><br>● 80/ _ _ Concrete (Natural finish)                         | <b>LED temperature colour</b><br>/1_ 2700 K  CRI >80 710 lm 115 lm/W                                       | <b>Control</b><br>4101 _ _ / _ 0<br>On/ Off   | 990,00 € |
|                 | <b>Materials</b><br>Head: Concrete.<br>Base: Concrete. Diffuser: Methacrylate. | <b>Light Source and electronics</b><br>1 x LED 6,2 W 350 mA<br>Constant Current 350 mA<br>100~240V 50/60Hz | <b>Packaging</b><br>1 Box 0,88 x 0,35 x 0,34 m<br>Vol 0,1032 m <sup>3</sup><br>Gross weight 38,9 Kg Net weight 35,01 Kg |          |

|                 |  |  |   |          |
|-----------------|--|--|---|----------|
| <b>4106</b><br> | <b>Finishes</b><br>● 80/ _ _ Concrete (Natural finish)                         | <b>LED temperature colour</b><br>/1_ 2700 K  CRI >80 710 lm 118 lm/W                                       | <b>Control</b><br>4106 _ _ / _ 0<br>On/ Off   | 850,00 € |
|                 | <b>Materials</b><br>Head: Concrete.<br>Base: Concrete. Diffuser: Methacrylate. | <b>Light Source and electronics</b><br>1 x LED 6,2 W 350 mA<br>Constant Current 350 mA<br>100~240V 50/60Hz | <b>Packaging</b><br>1 Box 0,88 x 0,35 x 0,34 m<br>Vol 0,0598 m <sup>3</sup><br>Gross weight 21,5 Kg Net weight 19,35 Kg |          |



4108

- Finishes
- 07/ \_ \_ Khaki (RAL 7006)
  - 54/ \_ \_ Oxide (RAL 8014)

LED colour temperature  
 /1\_ 2700 K   
 CRI >80 2500 lm 118 lm/W

Control  
 4108 \_ \_ / \_ 0  
 On/ Off 1.355,00 €

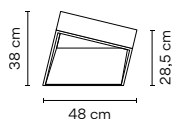

Materials  
 Body: Steel.  
 Diffuser: Methacrylate.

Light Source and electronics  
 2 x LED Strip 9,2 W 400 mA  
 Constant Current 400 mA  
 220~240V 50/60Hz

Packaging  
 1 Box 0,49 x 0,51 x 0,52 m  
 Vol 0,1312 m<sup>3</sup>  
 Gross weight 6,6 Kg Net weight 16 Kg

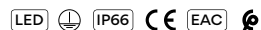

4110

- Finishes
- 80/ \_ \_ Concrete (Natural finish)

LED temperature colour  
 /1\_ 2700 K   
 CRI >80 199 lm 95 lm/W

Control  
 4110 \_ \_ / \_ 0  
 On/ Off 230,00 €

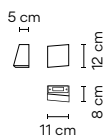

Materials  
 Body: Aluminum / Concrete.  
 Diffuser: Methacrylate.

Light Source and electronics  
 1 x LED 2,1 W 700 mA  
 Constant Current 700 mA  
 100~240V 50/60Hz

Packaging  
 1 Box 0,260 x 0,260 x 0,260 m  
 Vol 1,0000 m<sup>3</sup>  
 Gross weight 2,30 Kg Net weight 2,07 Kg

Notes  
**UNTIL STOCK RUNS OUT**  

# Break Plus

Design by Xuclà

An extension of the existing Break collection, defined by an instinctual connection to the landscape and surrounding architecture, Break Plus converts any wall into a three dimensional mural, casting diffuse, indirect light upwards, downwards or in both directions.

## Outdoor

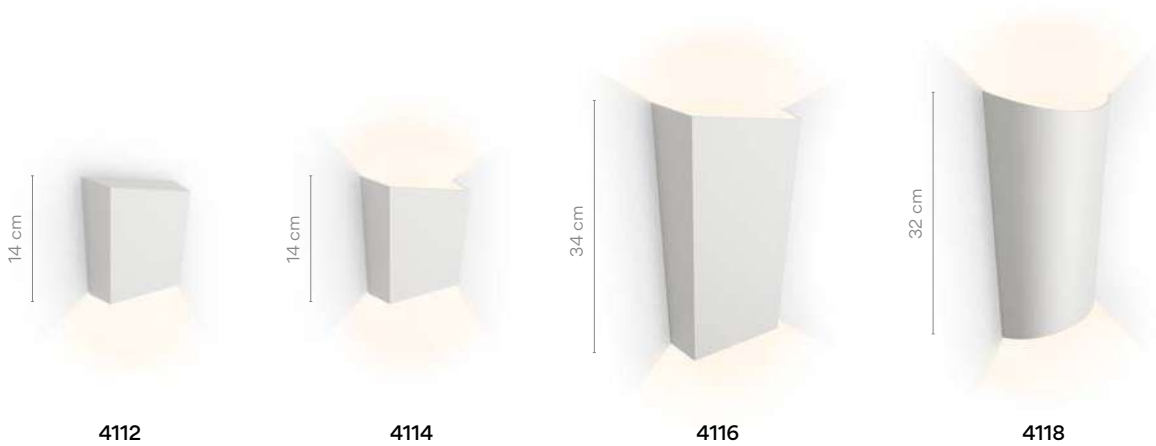

**4112**

**Finishes**

- **22/** \_\_ Graphite Black (NCS S 8000-N)
- **25/** \_\_ Beige D1 (NCS S 4005-Y50R)
- **37/** \_\_ Terra Red (NCS S 4040-Y70R)
- **95/** \_\_ Primer (RAL 9016)

**LED temperature colour**

- /1 \_ 2700 K CRI >90 113,73 lm 113,73 lm/W
- /3 \_ 3500 K CRI >90 146,22 lm 146,22 lm/W

**Control**

|                          |                 |
|--------------------------|-----------------|
| <b>4112</b> _ / _ 0      | <b>285,00 €</b> |
| <b>4112</b> _ / _ 1 _ 30 | <b>300,00 €</b> |
| DALI (Remote)            |                 |
| <b>4112</b> _ / _ Z _ 30 | <b>405,00 €</b> |
| Casambi ( Remote)        |                 |

**Materials**

Body: Aluminium.  
Diffuser: Polycarbonate.

**Light Source and electronics**

1 x LED 1W 350 mA  
Constant Current 350 mA  
100~240Vac. 50/60Hz

**Packaging**

1 Box 0,07 x 0,19 x 0,23 m  
Vol 0,0030 m<sup>3</sup>  
Gross weight 1 Kg Net weight 0,610 Kg

**4114**

**Finishes**

- **22/** \_\_ Graphite Black (NCS S 8000-N)
- **25/** \_\_ Beige D1 (NCS S 4005-Y50R)
- **37/** \_\_ Terra Red (NCS S 4040-Y70R)
- **95/** \_\_ Primer (RAL 9016)

**LED temperature colour**

- /1 \_ 2700 K CRI >90 227,46 lm 113,73 lm/W
- /3 \_ 3500 K CRI >90 292,44 lm 146,22 lm/W

**Control**

|                          |                 |
|--------------------------|-----------------|
| <b>4114</b> _ / _ 0      | <b>315,00 €</b> |
| <b>4114</b> _ / _ 1 _ 30 | <b>335,00 €</b> |
| DALI (Remote)            |                 |
| <b>4114</b> _ / _ Z _ 30 | <b>435,00 €</b> |
| Casambi ( Remote)        |                 |

**Materials**

Body: Aluminium.  
Diffuser: Polycarbonate.

**Light Source and electronics**

2 x LED 1W 350 mA  
Constant Current 350 mA  
100~240Vac. 50/60Hz

**Packaging**

1 Box 0,07 x 0,19 x 0,23 m  
Vol 0,0030 m<sup>3</sup>  
Gross weight 1 Kg Net weight 0,590 Kg



4116

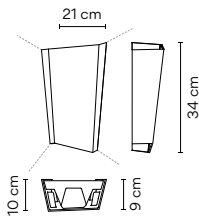

|   |   |  |                 |
|---|---|--|-----------------|
| <b>Finishes</b>   | <b>LED temperature colour</b>                       | <b>Control</b>   |                 |
| ● <b>22/</b> _ _ Graphite Black<br>(NCS S 8000-N)                   | <b>/1</b> _ 2700 K<br>CRI >90 707,52 lm 90,7 lm/W   | <b>4116</b> _ _ / _ 0<br>On/ Off   | <b>585,00 €</b> |
| ● <b>25/</b> _ _ Beige D1<br>(NCS S 4005-Y50R)                      | <b>/3</b> _ 3500 K<br>CRI >90 925,22 lm 118,61 lm/W | <b>4116</b> _ _ / _ 1 30<br>DALI (Remote)  | <b>615,00 €</b> |
| ● <b>37/</b> _ _ Terra Red<br>(NCS S 4040-Y70R)                     |   | <b>4116</b> _ _ / _ Z 30<br>Casambi ( Remote)  | <b>705,00 €</b> |
| ● <b>95/</b> _ _ Primer<br>(RAL 9016)                               |   |  |                 |
| <b>Materials</b>  |   | <b>Packaging</b>   |                 |
| Body: Aluminium.<br>Diffuser: Polycarbonate.                        |   | 1 Box 0,11 x 0,27 x 0,42 m<br>Vol 0,0120 m <sup>3</sup><br>Gross weight 3,2 Kg Net weight 2,2 Kg |                 |
| <b>Light Source and electronics</b>                                 |   |  |                 |
| 2 x LED 4W 350 mA<br>Constant Current 350 mA<br>100~240Vac. 50/60Hz |   |  |                 |

4118

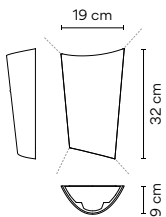

|   |   |   |                 |
|---|---|---|-----------------|
| <b>Finishes</b>   | <b>LED temperature colour</b>                       | <b>Control</b>  |                 |
| ● <b>22/</b> _ _ Graphite Black<br>(NCS S 8000-N)                   | <b>/1</b> _ 2700 K<br>CRI >90 707,52 lm 90,7 lm/W   | <b>4118</b> _ _ / _ 0<br>On/ Off  | <b>575,00 €</b> |
| ● <b>25/</b> _ _ Beige D1<br>(NCS S 4005-Y50R)                      | <b>/3</b> _ 3500 K<br>CRI >90 925,22 lm 118,61 lm/W | <b>4118</b> _ _ / _ 1 30<br>DALI (Remote)   | <b>605,00 €</b> |
| ● <b>37/</b> _ _ Terra Red<br>(NCS S 4040-Y70R)                     |   | <b>4118</b> _ _ / _ Z 30<br>Casambi ( Remote)   | <b>695,00 €</b> |
| ● <b>95/</b> _ _ Primer<br>(RAL 9016)                               |   |   |                 |
| <b>Materials</b>  |   | <b>Packaging</b>  |                 |
| Body: Aluminium.<br>Diffuser: Polycarbonate.                        |   | 1 Box 0,11 x 0,27 x 0,42 m<br>Vol 0,0120 m <sup>3</sup><br>Gross weight 3,2 Kg Net weight 1,71 Kg |                 |
| <b>Light Source and electronics</b>                                 |   |   |                 |
| 2 x LED 4W 350 mA<br>Constant Current 350 mA<br>100~240Vac. 50/60Hz |   |   |                 |

# Empty

Design by Xuclà

A sculpture by day and lighting by night, this outdoor fixture embodies multifunctional design. Its crisp angles create a cantilevered perch that serves as a side table or stool.

## Outdoor



### 4125

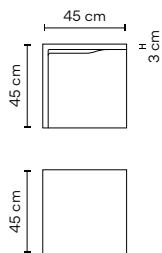

|  |   |                          |
|--|---|--------------------------|
| <b>Finishes</b>  | <b>LED temperature colour</b>   | <b>Control</b>           |
| ● 18/ __ Polymer<br>Concrete Grey<br>(NCS S 2002-B50G) | /1 _ 2700 K<br>CRI >80 664 lm 39 lm/W<br>/3 _ 3500 K<br>CRI >90 1247 lm 72,5 lm/W | 4125 __ / _ 0<br>On/ Off |

1.160,00 €

#### Materials

Body: Polymer concrete.  
Diffuser: Methacrylate.

#### Light Source and electronics

2 x LED STRIP 24V 8,6 W  
Constant Voltage 24V  
100~277V 50/60Hz

#### Packaging

1 Box 0,56 x 0,50 x 0,50 m  
Vol 0,176 m<sup>3</sup>  
Gross weight 40 Kg Net weight 36 Kg

#### Notes

Resistance to weight: 150 kg evenly distributed over the cantilevered surface of the lamp. This force should not be applied by impact.

### 4130

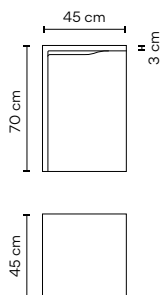

|  |   |                          |
|--|---|--------------------------|
| <b>Finishes</b>  | <b>LED temperature colour</b>   | <b>Control</b>           |
| ● 18/ __ Polymer<br>Concrete Grey<br>(NCS S 2002-B50G) | /1 _ 2700 K<br>CRI >80 664 lm 39 lm/W<br>/3 _ 3500 K<br>CRI >90 1247 lm 72,5 lm/W | 4130 __ / _ 0<br>On/ Off |

1.285,00 €

#### Materials

Body: Polymer concrete.  
Diffuser: Methacrylate.

#### Light Source and electronics

2 x LED STRIP 24V 8,6 W  
Constant Voltage 24V  
100~277V 50/60Hz

#### Packaging

1 Box 0,56 x 0,56 x 0,81 m  
Vol 0,254 m<sup>3</sup>  
Gross weight 54,7 Kg Net weight 49,7 Kg

#### Notes

Resistance to weight: 150 kg evenly distributed over the cantilevered surface of the lamp. This force should not be applied by impact.





4135

|  |  |                          |          |
|--|--|--------------------------|----------|
| <b>Finishes</b>                                  | <b>LED temperature colour</b>  | <b>Control</b>           |          |
| ● 18/ __ Polymer Concrete Grey (NCS S 2002-B50G) | /1_ 2700 K  CRI >80 304 lm 35 lm/W<br>/3_ 3500 K  CRI >90 1247 lm 145 lm/W | 4135 __ / _ 0<br>On/ Off | 780,00 € |

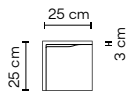

**Materials**

Body: Polymer concrete.  
Diffuser: Methacrylate.

**Light Source and electronics**

2 x LED STRIP 24V 4,3 W  
Constant Voltage 24V  
100~240V 50/60Hz

**Packaging**

1 Box 0,36 x 0,36 x 0,36 m  
Vol 0,04 m<sup>3</sup>  
Gross weight 12,2 Kg Net weight 10,4 Kg

**Notes**

Resistance to weight: 150 kg evenly distributed over the cantilevered surface of the lamp. This force should not be applied by impact.

LED IP66 CE EAC Bi-volt

4136

|  |  |                          |          |
|--|--|--------------------------|----------|
| <b>Finishes</b>                                  | <b>LED temperature colour</b>  | <b>Control</b>           |          |
| ● 18/ __ Polymer Concrete Grey (NCS S 2002-B50G) | /1_ 2700 K  CRI >80 304 lm 35 lm/W<br>/3_ 3500 K  CRI >90 1247 lm 145 lm/W | 4136 __ / _ 0<br>On/ Off | 870,00 € |

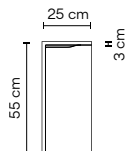

**Materials**

Body: Polymer concrete.  
Diffuser: Methacrylate.

**Light Source and electronics**

2 x LED STRIP 24V 4,3 W  
Constant Voltage 24V  
100~240V 50/60Hz

**Packaging**

1 Box 0,36 x 0,36 x 0,65 m  
Vol 0,084 m<sup>3</sup>  
Gross weight 22 Kg Net weight 19 Kg

**Notes**

Resistance to weight: 150 kg evenly distributed over the cantilevered surface of the lamp. This force should not be applied by impact.

LED IP66 CE Dimmer Bi-volt

# Fold Surface

Design by Arik Levy

Fold features a geometric design that creates a striking three-dimensional illumination effect. Light and shadow are projected from its cubic shapes, washing the wall with glowing chevron patterns.

## Wall

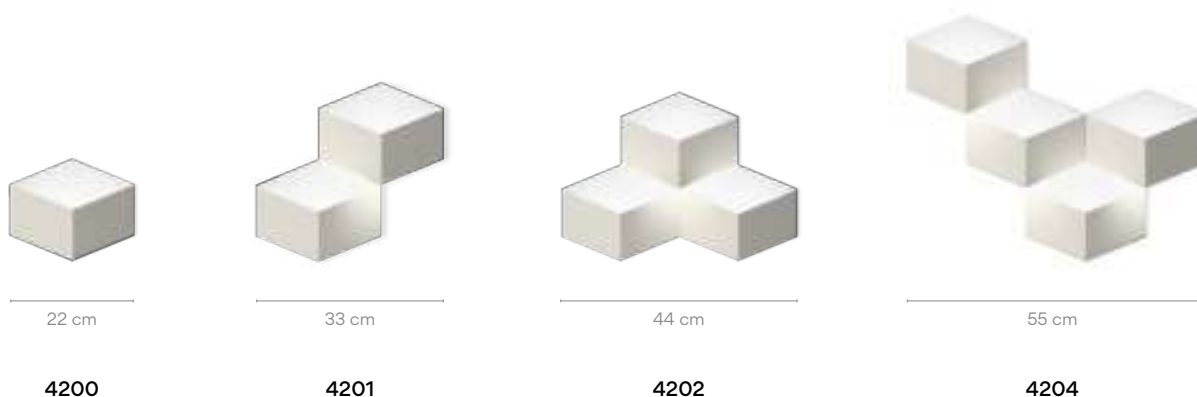

**4200**

|  |  |  |  |   |
|--|--|--|--|---|
|  | <b>Finishes</b><br><ul style="list-style-type: none"> <li>● <b>07/</b> __ Green (PANTONE 385)</li> <li>● <b>14/</b> __ Chocolate (RAL 8019)</li> <li>● <b>58/</b> __ Off-white (RAL D2 1109005)</li> </ul> | <b>LED temperature colour</b><br>/1_ 2700 K<br>CRI >90 362,4 lm 86 lm/W  | <b>Control</b><br>4200 __ / _ 0<br>On/ Off   | <b>250,00 €</b>                                 |
|  | <b>Materials</b><br>Shade: Aluminum. Body: Aluminum.<br>Diffuser: Polycarbonate.   | <b>Packaging</b><br>1 Box 0,26 x 0,26 x 0,16 m<br>Vol 0,0116 m <sup>3</sup><br>Gross weight 1,3 Kg Net weight 0,8 Kg | <b>Light Source and electronics</b><br>2 x LED 2,1 W 700 mA<br>Constant Current 700 mA<br>100~240V 50/60Hz | <b>Notes</b><br><b>UNTIL STOCK RUNS OUT</b><br> |

**4201**

|  |  |  |  |   |
|--|--|--|--|---|
|  | <b>Finishes</b><br><ul style="list-style-type: none"> <li>● <b>07/</b> __ Green (PANTONE 385)</li> <li>● <b>14/</b> __ Chocolate (RAL 8019)</li> <li>● <b>58/</b> __ Off-white (RAL D2 1109005)</li> </ul> | <b>LED temperature colour</b><br>/1_ 2700 K<br>CRI >90 724,9 lm 86 lm/W  | <b>Control</b><br>4201 __ / _ 0<br>On/ Off   | <b>490,00 €</b>                                 |
|  | <b>Materials</b><br>Shade: Aluminum. Body: Aluminum.<br>Diffuser: Polycarbonate.   | <b>Packaging</b><br>1 Box 0,41 x 0,41 x 0,21 m<br>Vol 0,0353 m <sup>3</sup><br>Gross weight 2,8 Kg Net weight 1,6 Kg | <b>Light Source and electronics</b><br>4 x LED 2,1 W 700 mA<br>Constant Current 700 mA<br>100~240V 50/60Hz | <b>Notes</b><br><b>UNTIL STOCK RUNS OUT</b><br> |



4202

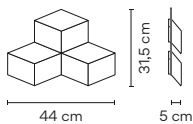

- Finishes
- 07/ \_ \_ Green (PANTONE 385)
  - 14/ \_ \_ Chocolate (RAL 8019)
  - 58/ \_ \_ Off-white (RAL D2 1109005)

LED temperature colour  
 /1 \_ 2700 K CRI >90 1087,3 lm 86 lm/W

Control  
 4202 \_ \_ / \_ 0 735,00 €  
 On/ Off

Materials

Shade: Aluminum. Body: Aluminum.  
 Diffuser: Polycarbonate.

Light Source and electronics

6 x LED 2,1 W 700 mA  
 Constant Current 700 mA  
 100~240V 50/60Hz

Packaging

1 Box 0,17 x 0,51 x 0,51 m  
 Vol 0,0429 m<sup>3</sup>  
 Gross weight 4,2 Kg Net weight 2,4 Kg

Notes

UNTIL STOCK RUNS OUT



4204

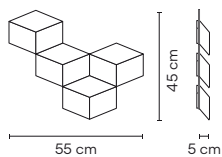

- Finishes
- 07/ \_ \_ Green (PANTONE 385)
  - 14/ \_ \_ Chocolate (RAL 8019)
  - 58/ \_ \_ Off-white (RAL D2 1109005)

LED temperature colour  
 /1 \_ 2700 K CRI >90 1449,8 lm 86 lm/W

Control  
 4204 \_ \_ / \_ 0 1.025,00 €  
 On/ Off

Materials

Shade: Aluminum. Body: Aluminum.  
 Diffuser: Polycarbonate.

Light Source and electronics

8 x LED 2,1 W 700 mA  
 Constant Current 700 mA  
 100~240V 50/60Hz

Packaging

1 Box 0,27 x 0,60 x 0,60 m  
 Vol 0,0972 m<sup>3</sup>  
 Gross weight 5,7 Kg Net weight 3,2 Kg

Notes

UNTIL STOCK RUNS OUT



# Out

Design by Víctor Carrasco

A romantic response to the global transition to life outside, Out brings the intimacy of indoor lighting outdoors. Suitable for illuminating a table or meeting point, this luminaire emanates with a soft, diffuse downlight, its source obscured by a translucent screen.

## Floor



4270



4275

### 4270

#### Finishes

- **22/** \_\_ Graphite Black (NCS S 8000N)
- **23/** \_\_ Warm White (NCS S 0502-Y50R)
- **25/** \_\_ Beige D1 (NCS S 4005-Y50R)
- **36/** \_\_ Soft Pink (NCS S 1010-Y50R)
- **37/** \_\_ Terra Red (NCS S 4040-Y70R)
- **47/** \_\_ Green L1 (NCS S 4005-G80Y)

#### LED temperature colour

/1 \_ 2700 K   
CRI >90 1300 lm 104,83 lm/W

#### Control

|               |            |
|---------------|------------|
| 4270 __ / _ 5 | 3.350,00 € |
| Push          |            |
| 4270 __ / _ Z | 3.470,00 € |
| Casambi       |            |

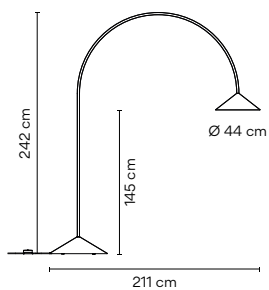

#### Materials

Tube: Stainless Steel. Shades: Aluminium.  
Diffuser: Polyethylene.

#### Light Source and electronics

1 x LED 12,4W 700 mA  
Constant Voltage 24V 1.0A  
220-240V. 50/60Hz

#### Packaging

5 Boxes  
Box 1: 0,17 x 0,39 x 0,51 m  
Box 2: 0,17 x 0,39 x 0,51 m  
Box 3: 0,60 x 0,60 x 0,27 m  
Box 4: 0,72 x 0,72 x 0,32 m  
Box 5: 2,40 x 2,10 x 0,1 m  
Total Vol 0,835 m<sup>3</sup>  
Gross weight 59 Kg Net weight 48 Kg

#### Notes

Surface cable 4 m





4275

| Finishes                              | LED temperature colour   | Control          |            |
|---------------------------------------|--|------------------|------------|
| ● 22/ __ Graphite Black (NCS S 8000N) | /1_ 2700 K  | 4275 __ / _ 1    | 3.250,00 € |
| ● 23/ __ Warm White (NCS S 0502-Y50R) | CRI >90 1300 lm 104,83 lm/W  | DALI             |            |
| ● 25/ __ Beige D1 (NCS S 4005-Y50R)   |  | 4275 __ / _ Z    | 3.370,00 € |
| ● 36/ __ Soft Pink (NCS S 1010-Y50R)  |  | Casambi (Remote) |            |
| ● 37/ __ Terra Red (NCS S 4040-Y70R)  |  |                  |            |
| ● 47/ __ Green L1 (NCS S 4005-G80Y)   |  |                  |            |

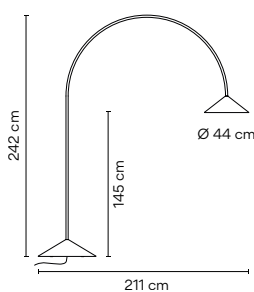

#### Materials

Tube: Stainless Steel. Shades: Aluminium.  
 Diffuser: Poliethylene.

#### Light Source and electronics

1 x LED 12,4W 700 mA  
 Constant Current 700 mA  
 220~240V. 50/60Hz

#### Packaging

5 Boxes  
 Box 1: 0,17 x 0,39 x 0,51 m  
 Box 2: 0,17 x 0,39 x 0,51 m  
 Box 3: 0,60 x 0,60 x 0,27 m  
 Box 4: 0,72 x 0,72 x 0,32 m  
 Box 5: 2,40 x 2,10 x 0,1 m  
 Total Vol 0,835 m<sup>3</sup>  
 Gross weight 59 Kg Net weight 48 Kg

#### Notes

Bolt-down "hard wired"





# Up



Design by Ramos & Bassols

Inspired by the look of neoclassical cornices, Up blends seamlessly into the ceiling. With its flat LED diffusion system and refined rim, it gives the appearance of uniform light passing from an opening in the ceiling through a sleek frame.

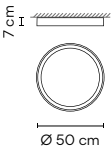
## Ceiling

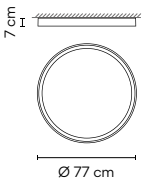

|  |  |  |  |
|--|--|--|--|
| <b>4440</b><br> | <b>Finishes</b><br><ul style="list-style-type: none"> <li>● <b>18/</b> _ _ Graphite (RAL 7016)</li> <li>● <b>93/</b> _ _ White (RAL 9016)</li> </ul> | <b>LED temperature colour</b><br><ul style="list-style-type: none"> <li><b>/1</b> _ 2700 K  CRI &gt;90 2207 lm 98 lm/W</li> <li><b>/4</b> _ 4000 K  CRI &gt;90 2982 lm 132,5 lm/W</li> </ul> | <b>Control</b><br><b>4440</b> _ _ / _ A DALI-2, 1-10V, Push <b>1.185,00 €</b><br><b>4440</b> _ _ / _ Z Casambi <b>1.305,00 €</b> |
|  | <b>Finish customization</b><br>(Available options: Vibia colour palette)   | <b>Materials</b><br>Diffuser: Polycarbonate. Body: Aluminum. Ceiling support: Steel.   | <b>Packaging</b><br>1 Box 0,17 x 0,55 x 0,55 m<br>Vol 0,0514 m <sup>3</sup><br>Gross weight 11 Kg Net weight 7,5 Kg              |

|  |  |   |  |
|--|--|---|--|
| <b>4442</b><br> | <b>Finishes</b><br><ul style="list-style-type: none"> <li>● <b>18/</b> _ _ Graphite (RAL 7016)</li> <li>● <b>93/</b> _ _ White (RAL 9016)</li> </ul> | <b>LED temperature colour</b><br><ul style="list-style-type: none"> <li><b>/1</b> _ 2700 K  CRI &gt;90 3959 lm 100 lm/W</li> <li><b>/4</b> _ 4000 K  CRI &gt;90 6159 lm 155,8 lm/W</li> </ul> | <b>Control</b><br><b>4442</b> _ _ / _ A DALI-2, 1-10V, Push <b>1.795,00 €</b><br><b>4442</b> _ _ / _ Z Casambi <b>1.915,00 €</b> |
|  | <b>Finish customization</b><br>(Available options: Vibia colour palette)   | <b>Materials</b><br>Diffuser: Polycarbonate. Body: Aluminum. Ceiling support: Steel.  | <b>Packaging</b><br>1 Box 0,17 x 0,90 x 0,90 m<br>Vol 0,1377 m <sup>3</sup><br>Gross weight 13 Kg Net weight 15 Kg               |

4452

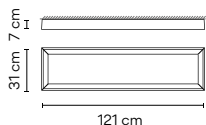

|                              |  |
|------------------------------|--|
| <b>Finishes</b>              | <b>LED temperature colour</b>          |
| ● 18/ __ Graphite (RAL 7016) | /1 _ 2700 K  CRI >90 3957 lm 79 lm/W   |
| ● 93/ __ White (RAL 9016)    | /4 _ 4000 K  CRI >90 4754 lm 95,1 lm/W |

**Finish customization**  
 (Available options:  
 Vibia colour palette)

**Materials**  
 Diffuser: Polycarbonate. Body: Aluminum.  
 Ceiling support: Steel.

**Light Source and electronics**  
 1 x LED PLATE 50 W 900 mA  
 Constant Current 900 mA  
 110-240V 50/60Hz

|                     |            |
|---------------------|------------|
| <b>Control</b>      |            |
| 4452 __ / _ A       | 1.490,00 € |
| DALI-2, 1-10V, Push |            |
| 4452 __ / _ Z       | 1.610,00 € |
| Casambi             |            |

**Packaging**  
 1 Box 0,17 x 0,42 x 1,31 m  
 Vol 0,0924 m<sup>3</sup>  
 Gross weight 14 Kg Net weight 12 Kg



4454

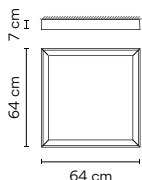

|                              |  |
|------------------------------|--|
| <b>Finishes</b>              | <b>LED temperature colour</b>          |
| ● 18/ __ Graphite (RAL 7016) | /1 _ 2700 K  CRI >90 3957 lm 79 lm/W   |
| ● 93/ __ White (RAL 9016)    | /4 _ 4000 K  CRI >90 4754 lm 95,1 lm/W |

**Finish customization**  
 (Available options:  
 Vibia colour palette)

**Materials**  
 Diffuser: Polycarbonate. Body: Aluminum.  
 Ceiling support: Steel.

**Light Source and electronics**  
 1 x LED PLATE 50 W 900 mA  
 Constant Current 900 mA  
 110-240V 50/60Hz

|                     |            |
|---------------------|------------|
| <b>Control</b>      |            |
| 4454 __ / _ A       | 1.355,00 € |
| DALI-2, 1-10V, Push |            |
| 4454 __ / _ Z       | 1.475,00 € |
| Casambi             |            |

**Packaging**  
 1 Box 0,17 x 0,73 x 0,73 m  
 Vol 0,0905 m<sup>3</sup>  
 Gross weight 14 Kg Net weight 13 Kg



4460

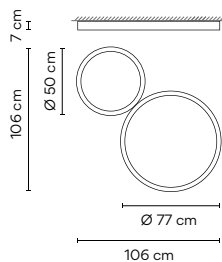

|                              |   |
|------------------------------|---|
| <b>Finishes</b>              | <b>LED temperature colour</b>           |
| ● 18/ __ Graphite (RAL 7016) | /1 _ 2700 K  CRI >90 4140,22 lm 66 lm/W |
| ● 93/ __ White (RAL 9016)    | /4 _ 4000 K  CRI >90 9141 lm 145,1 lm/W |

**Finish customization**  
 (Available options:  
 Vibia colour palette)

**Materials**  
 Diffuser: Polycarbonate. Body: Aluminum.  
 Ceiling support: Steel.

**Light Source and electronics**  
 1 x LED PLATE 26,5 W 700 mA  
 1 x LED PLATE 55,3W 750 mA  
 Constant Current 700 / 750 mA  
 110-240V 50/60Hz

|                     |            |
|---------------------|------------|
| <b>Control</b>      |            |
| 4460 __ / _ A       | 3.030,00 € |
| DALI-2, 1-10V, Push |            |
| 4460 __ / _ Z       | 3.150,00 € |
| Casambi             |            |

**Packaging**  
 2 Boxes  
 Total Vol 0,1891 m<sup>3</sup>  
 Gross weight 24 Kg Net weight 23 Kg

**Notes**  
 Only one electric connection point

# Origami

Design by Ramón Esteve

Recalling the folded paper of the Japanese art form for which it's named, Origami generates a stunning play of light and shadows. Composed of two architectural modules that be arranged in countless personalized designs, it creates the effect of climbing ivy along a blank expanse of wall.

---

## Wall Outdoor

**4500**

30 cm



**4501**

30 cm



**4504**

53 cm



**4506**

73 cm



**4508**

94 cm





Each project is unique. Visit [vibia.com](http://vibia.com) and chose among multiple compositions designed and adapted to your project needs.

Personalise your own Origami composition quick and easy at [vibia.com](http://vibia.com)

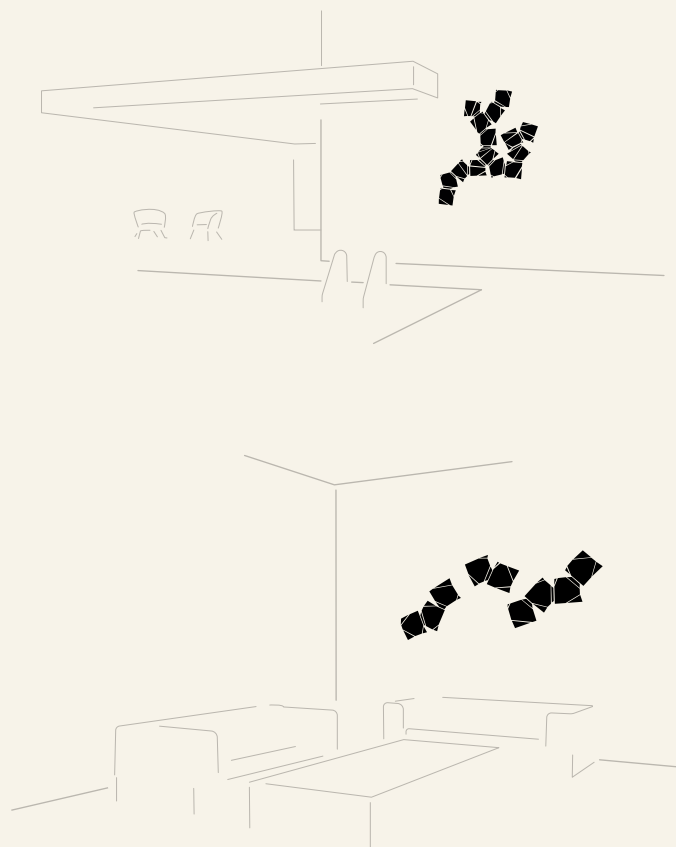

4500

Finishes

- 10/ \_\_ White (NCS S 0300-N)
- 29/ \_\_ Brown D1 (NCS S 8005-Y50R)
- 38/ \_\_ Terra Dark (NCS S 5040-Y70R)
- 53/ \_\_ Green M1 (NCS S 6005-G80Y)

LED temperature colour

- /1 \_ 2700 K **D**  
CRI >90 756,42 lm 120 lm/W
- /3 \_ 3500 K **E**  
CRI >90 799,1 lm 126,8 lm/W

Control

4500 \_\_ / \_\_ 4 290,00 €  
 TRIAC

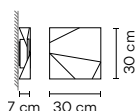

Materials

Shade: ABS. Diffuser: Polycarbonate.  
 Lid: Polycarbonate. Arm: Polycarbonate.

Light Source and electronics

1 x LED STRIP 6,3 W 350 mA  
 Constant Current 350 mA  
 110-277V 50/60Hz

Packaging

1 Box 0,35 x 0,35 x 0,12 m  
 Vol 0,0150 m<sup>3</sup>  
 Gross weight 1,5 Kg Net weight 1 Kg

Notes

A maximum of 30 modules can be connected to a single connection point. For bigger compositions, check connection system

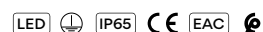

**4501**

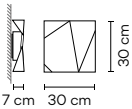

**Finishes**

- **10/** \_\_ White (NCS S 0300-N)
- **29/** \_\_ Brown D1 (NCS S 8005-Y50R)
- **38/** \_\_ Terra Dark (NCS S 5040-Y70R)
- **53/** \_\_ Green M1 (NCS S 6005-G80Y)

**LED temperature colour**

**/1** \_ 2700 K  CRI >90 756,42 lm 120 lm/W

**/3** \_ 3500 K  CRI >90 799,1 lm 126,8 lm/W

**Control**

**4501** \_\_ / \_ 4 **290,00 €**  
 TRIAC

---

**Materials**

Shade: ABS. Diffuser: Polycarbonate.  
 Lid: Polycarbonate. Arm: Polycarbonate.

**Light Source and electronics**





1 x LED STRIP 6,3 W 350 mA  
 Constant Current 350 mA  
 110-277V 50/60Hz

**Packaging**

1 Box 0,35 x 0,35 x 0,12 m  
 Vol 0,0150 m<sup>3</sup>  
 Gross weight 1,5 Kg Net weight 1 Kg

**Notes**

A maximum of 30 modules can be connected to a single connection point. For bigger compositions, check connection system

**4504**

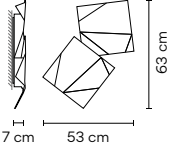

**Finishes**

- **10/** \_\_ White (NCS S 0300-N)
- **29/** \_\_ Brown D1 (NCS S 8005-Y50R)
- **38/** \_\_ Terra Dark (NCS S 5040-Y70R)
- **53/** \_\_ Green M1 (NCS S 6005-G80Y)

**LED temperature colour**

**/1** \_ 2700 K  CRI >90 1512,84 lm 120 lm/W

**/3** \_ 3500 K  CRI >90 1598,2 lm 126,8 lm/W

**Control**

**4504** \_\_ / \_ 4 **575,00 €**  
 TRIAC

---

**Materials**

Shade: ABS. Diffuser: Polycarbonate.  
 Lid: Polycarbonate. Arm: Polycarbonate.

**Light Source and electronics**





2 x LED STRIP 6,3 W 350 mA  
 Constant Current 350 mA  
 110-277V 50/60Hz

**Packaging**

1 Box 0,64 x 0,40 x 0,22 m  
 Vol 0,0563 m<sup>3</sup>  
 Gross weight 4,05 Kg Net weight 2,15 Kg

**Notes**

A maximum of 30 modules can be connected to a single connection point. For bigger compositions, check connection system

**4506**

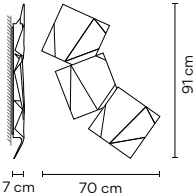

**Finishes**

- **10/** \_\_ White (NCS S 0300-N)
- **29/** \_\_ Brown D1 (NCS S 8005-Y50R)
- **38/** \_\_ Terra Dark (NCS S 5040-Y70R)
- **53/** \_\_ Green M1 (NCS S 6005-G80Y)

**LED temperature colour**

**/1** \_ 2700 K  CRI >90 2269,26 lm 120 lm/W

**/3** \_ 3500 K  CRI >90 2397,2 lm 126,8 lm/W

**Control**

**4506** \_\_ / \_ 4 **860,00 €**  
 TRIAC

---

**Materials**

Shade: ABS. Diffuser: Polycarbonate.  
 Lid: Polycarbonate. Arm: Polycarbonate.

**Light Source and electronics**





3 x LED STRIP 6,3 W 350 mA  
 Constant Current 350 mA  
 110-277V 50/60Hz

**Packaging**

1 Box 0,95 x 0,40 x 0,22 m  
 Vol 0,0836 m<sup>3</sup>  
 Gross weight 5,33 Kg Net weight 3,23 Kg

**Notes**

A maximum of 30 modules can be connected to a single connection point. For bigger compositions, check connection system

4508

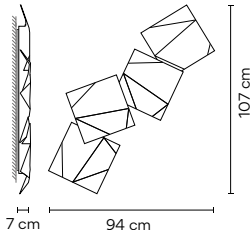

| Finishes   | LED temperature colour  | Control                 |                   |
|--|---|-------------------------|-------------------|
| <ul style="list-style-type: none"> <li>● 10/ _ _ White (NCS S 0300-N)</li> <li>● 29/ _ _ Brown D1 (NCS S 8005-Y50R)</li> <li>● 38/ _ _ Terra Dark (NCS S 5040-Y70R)</li> <li>● 53/ _ _ Green M1 (NCS S 6005-G80Y)</li> </ul> | /1 2700 K<br>CRI >90 3025,68 lm 120 lm/W<br>/3 3500 K<br>CRI >90 3196,3 lm 126,8 lm/W | 4508 _ _ / _ 4<br>TRIAC | <b>1.145,00 €</b> |

**Materials**

Shade: ABS. Diffuser: Polycarbonate.  
 Lid: Polycarbonate. Arm: Polycarbonate.

**Light Source and electronics**

4 x LED STRIP 6,3 W 350 mA  
 Constant Current 350 mA  
 110-277V 50/60Hz

**Packaging**

1 Box 1,25 x 0,40 x 0,22 m  
 Vol 0,1100 m<sup>3</sup>  
 Gross weight 7,2 Kg Net weight 6,48 Kg

**Notes**

A maximum of 30 modules can be connected to a single connection point. For bigger compositions, check connection system



# Palo Alto

Design by Xuclà

At once natural and architectural, Palo Alto creates the effect of illuminated landscaping. Its angular, tree-shaped silhouette integrates seamlessly with the outdoors whether displayed individually or in a group.

## Outdoor



**4510**

35 cm  
25 x 25 cm

**Finishes**

- 29/ \_\_ Brown D1 (S 8005-Y50R)
- 53/ \_\_ Green M1 (S 6005-G80Y)

**LED temperature colour**

- /1 \_ 2700 K CRI >90 179,64 lm 41 lm/W
- /3 \_ 3500 K CRI >90 179,6 lm 40,8 lm/W

**Control**

4510 \_\_ / \_ 0  
On/ Off

**965,00 €**

---

**Materials**

Body: Steel.  
Cover: Steel.

**Packaging**

1 Box 0,44 x 0,40 x 1,10 m  
Vol 0,2080 m<sup>3</sup>  
Gross weight 11,1 Kg Net weight 10 Kg

**Light Source and electronics**

2 x LED 2,2 W 700 mA  
Constant Current 700 mA  
220-240V 50/60Hz

**4516**

85 cm  
25 x 25 cm

**Finishes**

- 29/ \_\_ Brown D1 (S 8005-Y50R)
- 53/ \_\_ Green M1 (S 6005-G80Y)

**LED temperature colour**

- /1 \_ 2700 K CRI >90 1044,95 lm 70 lm/W
- /3 \_ 3500 K CRI >90 1045,0 lm 69,7 lm/W

**Control**

4516 \_\_ / \_ 0  
On/ Off

**1.415,00 €**

---

**Materials**

Body: Steel.  
Cover: Steel.

**Packaging**

1 Box 0,32 x 0,32 x 2,64 m  
Vol 0,2703 m<sup>3</sup>  
Gross weight 18,4 Kg Net weight 16,5 Kg

**Light Source and electronics**

1 x LED MODULE 24V 15 W  
Constant Voltage 24V  
100-240V 50/60Hz

4539

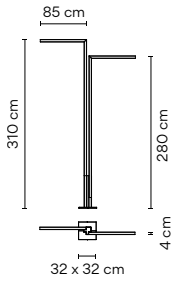

- Finishes**
- 29/ \_\_ Brown D1 (S 8005-Y50R)
  - 53/ \_\_ Green M1 (S 6005-G80Y)

| LED temperature colour |                             |
|------------------------|-----------------------------|
| /1 _ 2700 K            | CRI >90 2089,9 lm 70 lm/W   |
| /3 _ 3500 K            | CRI >90 2089,9 lm 69,7 lm/W |

| Control       |            |
|---------------|------------|
| 4539 __ / _ 0 | 2.820,00 € |
| On/ Off       |            |

**Materials**

Body: Steel.  
 Cover: Steel.

**Light Source and electronics**

2 x LED MODULE 24V 15 W  
 Constant Voltage 24V  
 100~240V 50/60Hz

**Packaging**

1 Box 0,37 x 0,37 x 2,61 m  
 Vol 0,3570 m<sup>3</sup>  
 Gross weight 46,4 Kg Net weight 41,76 Kg



4540

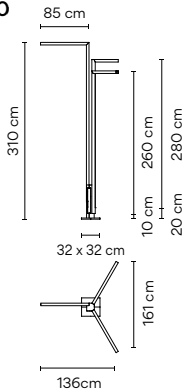

- Finishes**
- 29/ \_\_ Brown D1 (S 8005-Y50R)
  - 53/ \_\_ Green M1 (S 6005-G80Y)

| LED temperature colour |                             |
|------------------------|-----------------------------|
| /1 _ 2700 K            | CRI >90 3134,85 lm 70 lm/W  |
| /3 _ 3500 K            | CRI >90 3134,9 lm 69,7 lm/W |

| Control       |            |
|---------------|------------|
| 4540 __ / _ 0 | 3.590,00 € |
| On/ Off       |            |

**Materials**

Body: Steel.  
 Cover: Steel.

**Light Source and electronics**

3 x LED MODULE 24V 15 W  
 Constant Voltage 24V  
 100~240V 50/60Hz

**Packaging**

1 Box 0,40 x 0,44 x 2,64 m  
 Vol 0,4646 m<sup>3</sup>  
 Gross weight 55,4 Kg Net weight 49,86 Kg



# Brisa

Design by Lievore, Altherr, Molina

Inspired by the forest blue bell flower, Brisa adds a nature-inspired accent to any outdoor space. Its long, slender stem is topped with a pendant, conical shade and features adjustable, revolving arms.

## Outdoor



|                    |   |  |  |
|--------------------|---|--|--|
| <p><b>4625</b></p> | <p><b>Finishes</b></p> <ul style="list-style-type: none"> <li>● <b>07/</b> __ Khaki (RAL 7039)</li> <li>● <b>54/</b> __ Oxide (RAL 8014)</li> </ul> | <p><b>LED temperature colour</b></p> <ul style="list-style-type: none"> <li>/1 _ 2700 K  CRI &gt;90 181,22 lm 86 lm/W</li> <li>/3 _ 3500 K  CRI &gt;90 193,9 lm 92,3 lm/W</li> </ul> | <p><b>Control</b></p> <p><b>4625</b> __ / __ <b>0</b><br/>On/ Off</p> <p style="text-align: right;"><b>410,00 €</b></p> <hr/> <p><b>Materials</b></p> <p>Shade and Base: Aluminum. Disc: Stainless steel.<br/>Vertical tube: Steel.</p> <p><b>Light Source and electronics</b></p> <p>1 x LED 2,1 W 700 mA<br/>Constant Current 700 mA<br/>100-240V 50/60Hz</p> <p><b>Packaging</b></p> <p>1 Box 0,16 x 0,16 x 1,6 m<br/>Vol 0,0409 m<sup>3</sup><br/>Gross weight 1,8 Kg Net weight 1,3 Kg</p> <p><b>Notes</b></p> <p>Spike. Surface</p> <p> </p> |
|--------------------|---|--|--|

4630

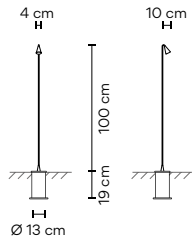

|                                   |   |
|-----------------------------------|---|
| <b>Finishes</b>                   | <b>LED temperature colour</b>                       |
| ● <b>07/</b> _ _ Khaki (RAL 7039) | /1_ 2700 K <b>G</b> →<br>CRI >90 543,66 lm 86 lm/W  |
| ● <b>54/</b> _ _ Oxide (RAL 8014) | /3_ 3500 K <b>F</b> →<br>CRI >90 581,7 lm 92,3 lm/W |

|                |                       |                 |
|----------------|-----------------------|-----------------|
| <b>Control</b> | <b>4630</b> _ _ / _ 0 | <b>395,00 €</b> |
|                | On/ Off               |                 |

**Materials**  
 Shade and Base: Aluminum. Disc: Stainless steel.  
 Vertical tube: Steel.

**Packaging**  
 1 Box 0,16 x 0,16 x 1,6 m  
 Vol 0,0409 m³  
 Gross weight 2,6 Kg Net weight 2 Kg

**Light Source and electronics**  
 1 x LED 2,1 W 700 mA  
 Constant Current 700 mA  
 100~240V 50/60Hz

**Notes**  
 Built-in  
 LED IP65   
 Bi-volt ø 13 cm

4635

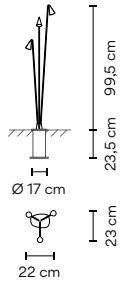

|                                   |   |
|-----------------------------------|---|
| <b>Finishes</b>                   | <b>LED temperature colour</b>                       |
| ● <b>07/</b> _ _ Khaki (RAL 7039) | /1_ 2700 K <b>G</b> →<br>CRI >90 906,1 lm 86 lm/W   |
| ● <b>54/</b> _ _ Oxide (RAL 8014) | /3_ 3500 K <b>F</b> →<br>CRI >90 969,5 lm 92,3 lm/W |

|                |                       |                 |
|----------------|-----------------------|-----------------|
| <b>Control</b> | <b>4635</b> _ _ / _ 0 | <b>860,00 €</b> |
|                | On/ Off               |                 |

**Materials**  
 Shade and Base: Aluminum. Disc: Stainless steel.  
 Vertical tube: Steel.

**Packaging**  
 1 Box 0,32 x 0,36 x 1,16 m  
 Vol 0,1336 m³  
 Gross weight 6,5 Kg Net weight 5,85 Kg

**Light Source and electronics**  
 3 x LED 2,1 W 700 mA  
 Constant Current 700 mA  
 100~240V 50/60Hz

**Notes**  
 Built-in  
 LED IP65   
 Bi-volt ø 17 cm

4640

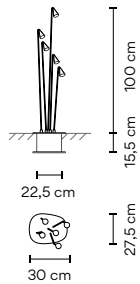

|                                   |  |
|-----------------------------------|--|
| <b>Finishes</b>                   | <b>LED temperature colour</b>                        |
| ● <b>07/</b> _ _ Khaki (RAL 7039) | /1_ 2700 K <b>G</b> →<br>CRI >90 1268,54 lm 86 lm/W  |
| ● <b>54/</b> _ _ Oxide (RAL 8014) | /3_ 3500 K <b>F</b> →<br>CRI >90 1357,3 lm 92,3 lm/W |

|                |                       |                   |
|----------------|-----------------------|-------------------|
| <b>Control</b> | <b>4640</b> _ _ / _ 0 | <b>1.315,00 €</b> |
|                | On/ Off               |                   |

**Materials**  
 Shade and Base: Aluminum. Disc: Stainless steel.  
 Vertical tube: Steel.

**Packaging**  
 1 Box 0,32 x 0,36 x 1,16 m  
 Vol 0,1336 m³  
 Gross weight 6 Kg Net weight 4 Kg

**Light Source and electronics**  
 5 x LED 2,1 W 700 mA  
 Constant Current 700 mA  
 100~240V 50/60Hz

**Notes**  
 Built-in  
 LED IP65   
 Bi-volt ø 22,5 cm

# Dots

Design by Martín Azúa

A diminutive wall sconce delivers outsized impact in the form of simple, circular dots. Seamlessly connecting a space with an intimate landscape of beams and halos, the collection creates a melody of light like a composition of musical notes in concert with another.

---

## Wall



**4660 - 4662**



**4665**



**4670**



**4675**



4660

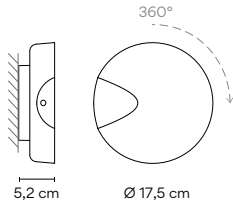

| Finishes                                | LED temperature colour                   | Control                  |          |
|---|--|--------------------------|----------|
| ● 13/ __ Off-White<br>(NCS S 1000-N)    | /1 _ 2700 K<br>CRI >90 482,65 lm 84 lm/W | 4660 __ / _ 0<br>On/ Off | 265,00 € |
| ● 27/ __ Brown L1<br>(NCS S 1505-Y50R)  |  | 4660 __ / _ 1<br>DALI-2  | 280,00 € |
| ● 37/ __ Terra Red<br>(NCS S 4040-Y70R) |  | 4660 __ / _ 3<br>1-10V   | 280,00 € |
| ● 47/ __ Green L1<br>(NCS S 4005-G80Y)  |  | 4660 __ / _ 4<br>TRIAC   | 280,00 € |

| Finishes                    | LED temperature colour                   | Control                  |          |
|-----------------------------|--|--------------------------|----------|
| ● 82/ __ White oak          | /1 _ 2700 K<br>CRI >90 482,65 lm 84 lm/W | 4660 __ / _ 0<br>On/ Off | 300,00 € |
| ● 83/ __ American<br>walnut |  | 4660 __ / _ 1<br>DALI-2  | 315,00 € |
|                             |  | 4660 __ / _ 3<br>1-10V   | 315,00 € |
|                             |  | 4660 __ / _ 4<br>TRIAC   | 315,00 € |

Materials

Body: ABS or Natural wood. Diffuser: Polycarbonate.  
 Canopy: Aluminum.

Light Source and electronics

1 x LED 5,75 W 500 mA  
 Constant Current 500 mA  
 220~240V 50/60Hz

Packaging

1 Box 0,13 x 0,22 x 0,21 m  
 Vol 0,0062 m<sup>3</sup>  
**ABS:** Gross weight 0,65 Kg  
 Net weight 0,4 Kg  
**Natural wood:** Gross weight 0,85 Kg  
 Net weight 0,6 Kg

Notes

22° light halo

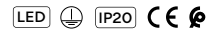

4662

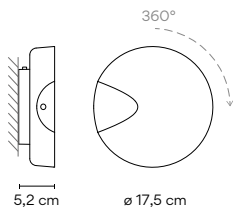

| Finishes                               | LED temperature colour                   | Control                  |          |
|--|--|--------------------------|----------|
| ● 13/ __ Off-White<br>(NCS S 1000-N)   | /1 _ 2700 K<br>CRI >90 482,65 lm 84 lm/W | 4662 __ / _ 0<br>On/ Off | 265,00 € |
| ● 27/ __ Brown L1<br>(NCS S 1505-Y50R) |  | 4662 __ / _ 4<br>TRIAC   | 280,00 € |

| Finishes                    | LED temperature colour                   | Control                  |          |
|-----------------------------|--|--------------------------|----------|
| ● 82/ __ White oak          | /1 _ 2700 K<br>CRI >90 482,65 lm 84 lm/W | 4662 __ / _ 0<br>On/ Off | 300,00 € |
| ● 83/ __ American<br>walnut |  | 4662 __ / _ 4<br>TRIAC   | 315,00 € |

Materials

Body: ABS or Natural wood. Diffuser: Polycarbonate.  
 Canopy: Aluminum.

Light Source and electronics

1 x LED 5,75 W 500 mA  
 Constant Current 500 mA  
 220~240V 50/60Hz

Packaging

1 Box 0,13 x 0,22 x 0,21 m  
 Vol 0,0062 m<sup>3</sup>  
**ABS:** Gross weight 0,65 Kg  
 Net weight 0,4 Kg  
**Natural wood:** Gross weight 0,85 Kg  
 Net weight 0,6 Kg





Notes

22° light halo  
 Switch on the back plate

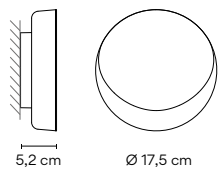







**4665**

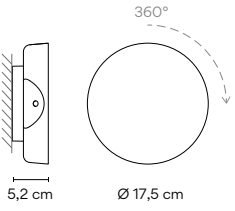

|  |   |   |
|--|---|---|
| <p><b>Finishes</b></p> <ul style="list-style-type: none"> <li>● <b>13/</b> __ Off-White (NCS S 1000-N)</li> <li>● <b>27/</b> __ Brown L1 (NCS S 1505-Y50R)</li> <li>● <b>37/</b> __ Terra Red (NCS S 4040-Y70R)</li> <li>● <b>47/</b> __ Green L1 (NCS S 4005-G80Y)</li> </ul> | <p><b>LED temperature colour</b></p> <p>/1_ 2700 K  CRI &gt;90 482,65 lm 84 lm/W</p> | <p><b>Control</b></p> <p><b>4665</b> __ / __ 0 265,00 €<br/>On/ Off</p>   |
| <p><b>Materials</b></p> <p>Body: ABS. Diffuser: Polycarbonate.<br/>Canopy: Aluminum.</p> <p><b>Light Source and electronics</b></p> <p>1 x LED 5,75 W 500 mA<br/>Constant Current 500 mA<br/>220~240V 50/60Hz</p>  |   | <p><b>Packaging</b></p> <p>1 Box 0,13 x 0,22 x 0,21 m<br/>Vol 0,0062 m<sup>3</sup><br/>Gross weight 0,65 Kg Net weight 0,4 Kg</p> <p>   </p> |

**4670**



|  |   |   |
|--|---|---|
| <p><b>Finishes</b></p> <ul style="list-style-type: none"> <li>● <b>13/</b> __ Off-White (NCS S 1000-N)</li> <li>● <b>27/</b> __ Brown L1 (NCS S 1505-Y50R)</li> <li>● <b>37/</b> __ Terra Red (NCS S 4040-Y70R)</li> <li>● <b>47/</b> __ Green L1 (NCS S 4005-G80Y)</li> </ul> | <p><b>LED temperature colour</b></p> <p>/1_ 2700 K  CRI &gt;90 482,65 lm 84 lm/W</p>   | <p><b>Control</b></p> <p><b>4670</b> __ / __ 0 265,00 €<br/>On/ Off</p> <p><b>4670</b> __ / __ 1 280,00 €<br/>DALI-2</p> <p><b>4670</b> __ / __ 3 280,00 €<br/>1-10V</p> <p><b>4670</b> __ / __ 4 280,00 €<br/>TRIAC</p>  |
| <p><b>Finishes</b></p> <ul style="list-style-type: none"> <li>● <b>82/</b> __ White oak</li> <li>● <b>83/</b> __ American walnut</li> </ul>  | <p><b>LED temperature colour</b></p> <p>/1_ 2700 K  CRI &gt;90 482,65 lm 84 lm/W</p> | <p><b>Control</b></p> <p><b>4670</b> __ / __ 0 315,00 €<br/>On/ Off</p> <p><b>4670</b> __ / __ 1 330,00 €<br/>DALI-2</p> <p><b>4670</b> __ / __ 3 330,00 €<br/>1-10V</p> <p><b>4670</b> __ / __ 4 330,00 €<br/>TRIAC</p>  |
| <p><b>Materials</b></p> <p>Body: ABS or Natural wood. Diffuser: Polycarbonate.<br/>Canopy: Aluminum.</p> <p><b>Light Source and electronics</b></p> <p>1 x LED 5,75 W 500 mA<br/>Constant Current 500 mA<br/>220~240V 50/60Hz</p>  |   | <p><b>Packaging</b></p> <p>1 Box 0,13 x 0,22 x 0,21 m<br/>Vol 0,0062 m<sup>3</sup><br/><b>ABS:</b> Gross weight 0,65 Kg<br/>Net weight 0,4 Kg<br/><b>Natural wood:</b> Gross weight 0,85 Kg<br/>Net weight 0,6 Kg</p> <p>   </p> |

4675

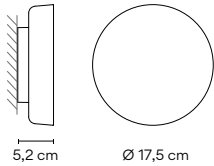

| Finishes                                 | LED temperature colour                   | Control                   |          |
|--|--|---------------------------|----------|
| ● 13/ _ _ Off-White<br>(NCS S 1000-N)    | /1_ 2700 K<br>CRI >90 573,83 lm 128 lm/W | 4675 _ _ / _ 0<br>On/ Off | 265,00 € |
| ● 27/ _ _ Brown L1<br>(NCS S 1505-Y50R)  |  | 4675 _ _ / _ 1<br>DALI-2  | 280,00 € |
| ● 37/ _ _ Terra Red<br>(NCS S 4040-Y70R) |  | 4675 _ _ / _ 3<br>1-10V   | 280,00 € |
| ● 47/ _ _ Green L1<br>(NCS S 4005-G80Y)  |  | 4675 _ _ / _ 4<br>TRIAC   | 280,00 € |

| Finishes                     | LED temperature colour                  | Control                   |          |
|------------------------------|---|---------------------------|----------|
| ● 82/ _ _ White oak          | /1_ 2700 K<br>CRI >90 482,65 lm 84 lm/W | 4675 _ _ / _ 0<br>On/ Off | 300,00 € |
| ● 83/ _ _ American<br>walnut |   | 4675 _ _ / _ 1<br>DALI-2  | 315,00 € |
|                              |   | 4675 _ _ / _ 3<br>1-10V   | 315,00 € |
|                              |   | 4675 _ _ / _ 4<br>TRIAC   | 315,00 € |

**Materials**

Body: ABS or Natural wood. Diffuser: Polycarbonate.  
 Canopy: Aluminum.

**Light Source and electronics**

1 x LED PLATE 4,5 W 500 mA  
 Constant Current 500 mA  
 100~240V 50/60Hz

**Packaging**

1 Box 0,13 x 0,22 x 0,21 m  
 Vol 0,0062 m<sup>3</sup>  
**ABS:** Gross weight 0,65 Kg  
 Net weight 0,4 Kg  
**Natural wood:** Gross weight 0,85 Kg  
 Net weight 0,6 Kg



# Dots Outdoor

Design by Martín Azúa

Easily mistaken for a stone during the day, this fixture is designed to nestle into the undergrowth of a garden or amongst the potted plants of a patio. Dots Outdoor shines at night with a low, diffuse and indirect glow, the source of which is invisible from almost any angle.

## Outdoor



ø 20 cm

4695



ø 16 cm

4697



ø 20 cm

4700



ø 16 cm

4702

4695

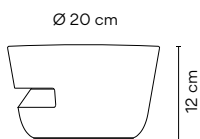

### Finishes

- 22/ \_\_ Graphite Black (NCS S 8000-N)
- 25/ \_\_ Beige D1 (NCS S 4005-Y50R)
- 53/ \_\_ Green M1 (NCS S 6005-G80Y)

### LED temperature colour

/1 \_ 2700 K   
CRI >90 750,2 lm 96,18 lm/W

### Control

|   |          |
|---|----------|
| 4695 __ / _ 0<br>On/ Off                | 625,00 € |
| 4695 __ / _ 1 _ 30<br>DALI ( Remote)    | 660,00 € |
| 4695 __ / _ Z _ 30<br>Casambi ( Remote) | 745,00 € |

### Materials

Body: Aluminium.  
Diffuser: Polycarbonate.

### Light Source and electronics

1 x LED STRIP 7,8W 350 mA  
Constant Current 350 mA  
100~277V 50/60Hz

### Packaging

1 Box 0,30 x 0,27 x 0,18 m  
Vol 0,0146 m<sup>3</sup>  
Gross weight 3,4 Kg Net weight 2,7 Kg

     Multi-volt

4697

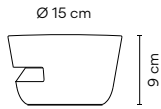

|   |                               |
|---|-------------------------------|
| <b>Finishes</b>                                   | <b>LED temperature colour</b> |
| ● <b>22/</b> _ _ Graphite Black<br>(NCS S 8000-N) | <b>/1</b> _ 2700 K            |
| ● <b>25/</b> _ _ Beige D1<br>(NCS S 4005-Y50R)    | CRI >90 375,9 lm 81,72 lm/W   |
| ● <b>53/</b> _ _ Green M1<br>(NCS S 6005-G80Y)    |                               |

|                                 |                 |
|---------------------------------|-----------------|
| <b>Control</b>                  |                 |
| <b>4697</b> _ _ / _ <b>0</b>    | <b>450,00 €</b> |
| On/ Off                         |                 |
| <b>4697</b> _ _ / _ <b>1 30</b> | <b>475,00 €</b> |
| DALI ( Remote)                  |                 |
| <b>4697</b> _ _ / _ <b>Z 30</b> | <b>570,00 €</b> |
| Casambi ( Remote)               |                 |

**Materials**  
 Body: Aluminium.  
 Diffuser: Polycarbonate.

**Light Source and electronics**  
 1x LED STRP 4,6W 350 mA  
 Constant Current 350 mA  
 100~240V 50/60Hz

**Packaging**  
 1 Box 0,24 x 0,20 x 0,13 m  
 Vol 0,0624 m³  
 Gross weight 1,9 Kg Net weight 1,5 Kg

4700

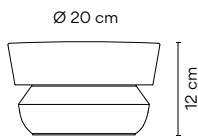

|   |                               |
|---|-------------------------------|
| <b>Finishes</b>                                   | <b>LED temperature colour</b> |
| ● <b>22/</b> _ _ Graphite Black<br>(NCS S 8000-N) | <b>/1</b> _ 2700 K            |
| ● <b>25/</b> _ _ Beige D1<br>(NCS S 4005-Y50R)    | CRI >90 1445 lm 97,64 lm/W    |
| ● <b>53/</b> _ _ Green M1<br>(NCS S 6005-G80Y)    |                               |

|                                 |                 |
|---------------------------------|-----------------|
| <b>Control</b>                  |                 |
| <b>4700</b> _ _ / _ <b>0</b>    | <b>685,00 €</b> |
| On/ Off                         |                 |
| <b>4700</b> _ _ / _ <b>1 30</b> | <b>720,00 €</b> |
| DALI ( Remote)                  |                 |
| <b>4700</b> _ _ / _ <b>Z 30</b> | <b>805,00 €</b> |
| Casambi ( Remote)               |                 |

**Materials**  
 Body: Aluminium.  
 Diffuser: Polycarbonate.

**Light Source and electronics**  
 1x LED STRIP 14,8W 350 mA  
 Constant Current 350 mA  
 100~277V 50/60Hz

**Packaging**  
 1 Box 0,30 x 0,27 x 0,18 m  
 Vol 0,0146 m³  
 Gross weight 3,8 Kg Net weight 3,1 Kg

4702

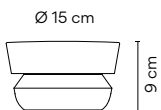

|   |                               |
|---|-------------------------------|
| <b>Finishes</b>                                   | <b>LED temperature colour</b> |
| ● <b>22/</b> _ _ Graphite Black<br>(NCS S 8000-N) | <b>/1</b> _ 2700 K            |
| ● <b>25/</b> _ _ Beige D1<br>(NCS S 4005-Y50R)    | CRI >90 1294 lm 101,1 lm/W    |
| ● <b>53/</b> _ _ Green M1<br>(NCS S 6005-G80Y)    |                               |

|                                 |                 |
|---------------------------------|-----------------|
| <b>Control</b>                  |                 |
| <b>4702</b> _ _ / _ <b>0</b>    | <b>490,00 €</b> |
| On/ Off                         |                 |
| <b>4702</b> _ _ / _ <b>1 30</b> | <b>515,00 €</b> |
| DALI ( Remote)                  |                 |
| <b>4702</b> _ _ / _ <b>Z 30</b> | <b>610,00 €</b> |
| Casambi ( Remote)               |                 |

**Materials**  
 Body: Aluminium.  
 Diffuser: Polycarbonate.

**Light Source and electronics**  
 1x LED STRIP 12,8W 300 mA  
 Constant Current 300 mA  
 100~277V 50/60Hz

**Packaging**  
 1 Box 0,24 x 0,20 x 0,13 m  
 Vol 0,0146 m³  
 Gross weight 1,9 Kg Net weight 1,5 Kg





# Meridiano





Design by Jordi Vilardell & Meritxell Vidal

Meridiano features a grid of steel slots through which LED light radiates outwards in a dramatic sunburst pattern. Topped with foam, it doubles as a seat or side table, its airy architecture integrating easily into outdoor spaces.

## Outdoor

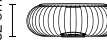

|  |   |   |  |  |
|--|---|---|--|--|
| <b>4710</b><br><br> 46 cm<br><br>Ø 64 cm | <b>Finishes</b><br>● <b>07/</b> __ Khaki (RAL 7006)<br>● <b>58/</b> __ Off-white (PANTONE WARM GRAY 2U) | <b>LED temperature colour</b><br>/1 _ 2700 K  CRI >90 1269 lm 141 lm/W<br>/3 _ 3500 K  CRI >80 1709 lm 189,9 lm/W | <b>Control</b><br><b>4710</b> __ / _ 0<br>On/ Off  | <b>1.645,00 €</b>  |
|  | <b>Materials</b><br>Seat: Polyurethane foam. Rods: Steel.<br>Arm: Steel. Diffuser: Glass.               | <b>Light Source and electronics</b><br>1 x LED 9 W 350 mA<br>Constant Current 350 mA<br>100~240V 50/60Hz  | <b>Packaging</b><br>1 Box 0,57 x 0,66 x 0,66 m<br>Vol 0,2483 m <sup>3</sup><br>Gross weight 18,2 Kg Net weight 15,6 Kg | <b>Notes</b><br>It can be connected with or without a plug |

|  |   |   |  |  |
|--|---|---|--|--|
| <b>4715</b><br><br> 32 cm<br><br>Ø 92 cm | <b>Finishes</b><br>● <b>07/</b> __ Khaki (RAL 7006)<br>● <b>58/</b> __ Off-white (PANTONE WARM GRAY 2U) | <b>LED temperature colour</b><br>/1 _ 2700 K  CRI >90 1269 lm 141 lm/W<br>/3 _ 3500 K  CRI >80 1709 lm 189,9 lm/W | <b>Control</b><br><b>4715</b> __ / _ 0<br>On/ Off  | <b>1.740,00 €</b>  |
|  | <b>Materials</b><br>Seat: Polyurethane foam. Rods: Steel.<br>Arm: Steel. Diffuser: Glass.               | <b>Light Source and electronics</b><br>1 x LED 9 W 350 mA<br>Constant Current 350 mA<br>100~240V 50/60Hz  | <b>Packaging</b><br>1 Box 0,43 x 0,94 x 0,94 m<br>Vol 0,38 m <sup>3</sup><br>Gross weight 20,1 Kg Net weight 16,7 Kg | <b>Notes</b><br>It can be connected with or without a plug |



4720

Finishes

- 07/ \_ \_ Khaki (RAL 7006)
- 58/ \_ \_ Off-white (PANTONE WARM GRAY 2U)

LED temperature colour

- /1 \_ 2700 K [D] CRI >90 1269 lm 141 lm/W
- /3 \_ 3500 K [C] CRI >80 1709 lm 189,9 lm/W

Control

4720 \_ \_ / \_ 0 290,00 €  
 On/ Off

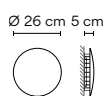

Materials

Base: Steel.

Light Source and electronics

1 x LED 9 W 350 mA  
 Constant Current 350 mA  
 100~240V 50/60Hz

Packaging

1 Box 0,106 x 0,310 x 0,310 m  
 Vol 0,102 m<sup>3</sup>  
 Gross weight 1,5 Kg Net weight 1 Kg



# June

Design by Ana Mir + Emili Padrós (emiliana design studio)

Inspired by traditional lanterns, June recall garlands festooned throughout an outdoor space. Its moon-like spheres cast a warm, ambient glow.

## Outdoor



4780

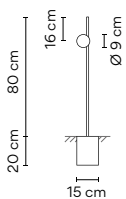

### Finishes

● 54/ \_\_ Brown  
(Pantone Black U)

### LED temperature colour

/1\_ 2700 K   
CRI >90 95,5 lm 95 lm/W

### Control

4780 \_\_ / \_ 0  
On/ Off

595,00 €

### Materials

Diffuser: Opal blown glass.  
Tubes: Steel.

### Light Source and electronics

1 x LED 1 W 350 mA  
Constant Current 350 mA  
100~240V 50/60Hz

### Packaging

1 Box 1 x 0,4 x 0,4 m  
Vol 0,16 m<sup>3</sup>  
Gross weight 5 Kg Net weight 3 Kg

### Notes

Electric cable 4 m





4785

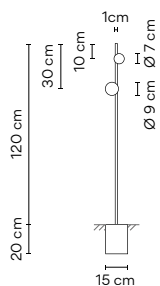

|   |  |   |                 |
|---|--|---|-----------------|
| <b>Finishes</b><br>● 54/ _ _ Brown<br>(Pantone Black U) | <b>LED temperature colour</b><br>/1_ 2700 K <b>F</b><br>CRI >90 190,9 lm 95 lm/W | <b>Control</b><br>4785 _ _ / _ 0<br>On/ Off | <b>750,00 €</b> |
|---|--|---|-----------------|

**Materials**

Diffuser: Opal blown glass.  
 Tubes: Steel.

**Light Source and electronics**

2 x LED 1 W 350 mA  
 Constant Current 350 mA  
 100-240V 50/60Hz

**Packaging**

1 Box 1,5 x 0,4 x 0,4 m  
 Vol 0,24 m<sup>3</sup>  
 Gross weight 6 Kg Net weight 4 Kg

**Notes**

Electric cable 4 m.

# Bamboo

Design by Antoni Arola & Enric Rodríguez

Bamboo's lean, natural form perfectly lends itself to an outdoor setting. Studded with LEDs, it seamlessly integrates with the landscape while adding a wash of light to walkways and common spaces.

## Outdoor

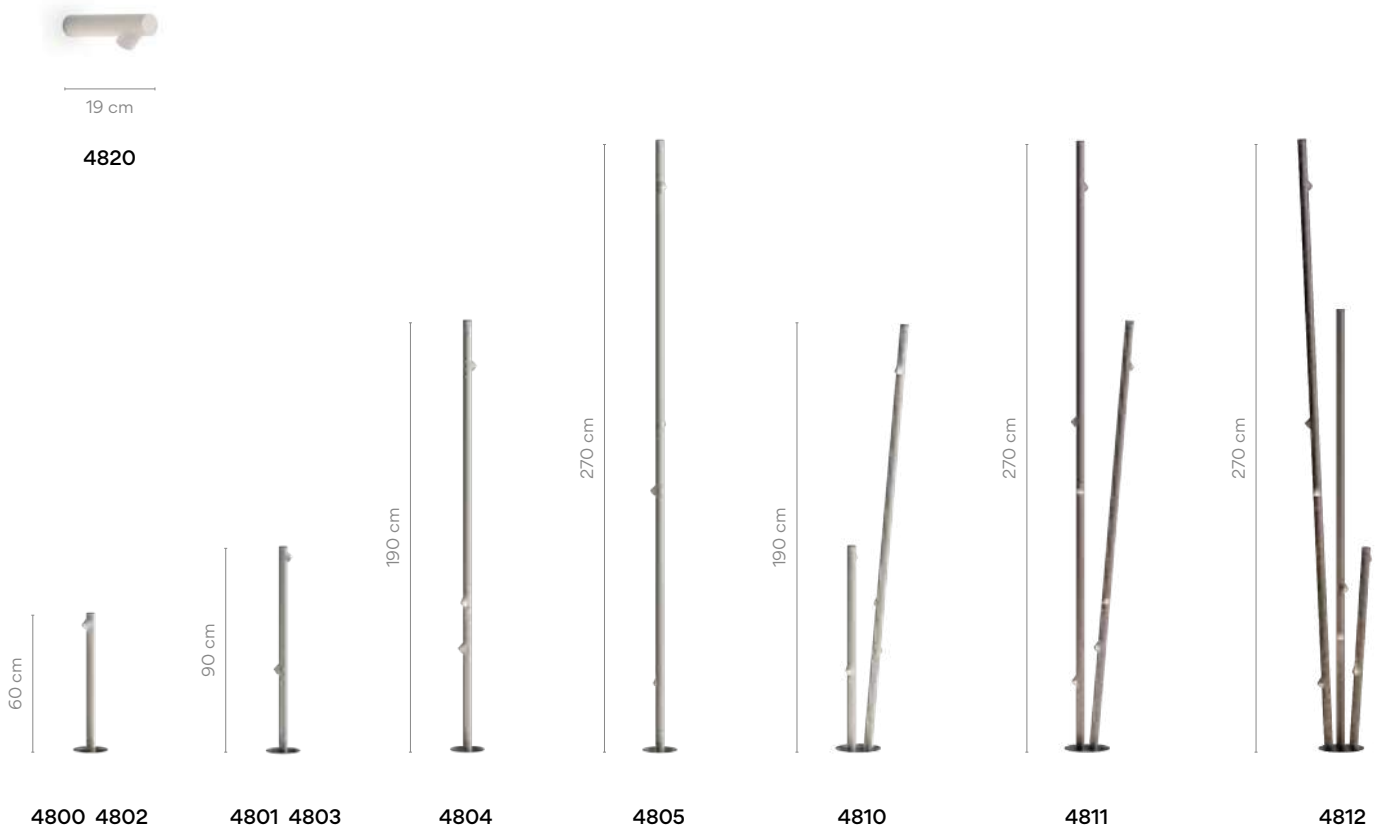

### 4800

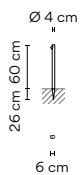

- Finishes**
- 07/ \_\_ Khaki (RAL 7006)
  - 54/ \_\_ Oxide (RAL 8017)
  - 58/ \_\_ Off-white (PANTONE WARM GRAY 2U)

- LED temperature colour**
- /1 \_ 2700 K CRI >90 181,2 lm 86 lm/W
  - /3 \_ 3500 K CRI >90 181,2 lm 86,3 lm/W

**Control**  
 4800 \_\_ / \_ 0 **650,00 €**  
 On/ Off

**Materials**  
 Cane: Resin + fiberglass.  
 Diffuser: Methacrylate.

**Light Source and electronics**  
 1 x LED 2,1 W 700 mA  
 Constant Current 700 mA  
 100~240V 50/60Hz

**Packaging**  
 1 Box 0,125 x 0,125 x 1,3 m  
 Vol 0,0203 m<sup>3</sup>  
 Gross weight 4 Kg Net weight 3,6 Kg

**Notes**  
 Surface



4801

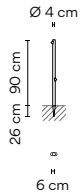

- Finishes**
- 07/ \_\_ Khaki (RAL 7006)
  - 54/ \_\_ Oxide (RAL 8017)
  - 58/ \_\_ Off-white (PANTONE WARM GRAY 2U)

- LED temperature colour**
- /1 \_ 2700 K CRI >90 362,4 lm 86 lm/W
  - /3 \_ 3500 K CRI >90 362,4 lm 86,3 lm/W

**Control**  
 4801 \_\_ / \_ 0 **790,00 €**  
 On/ Off

**Materials**  
 Cane: Resin + fiberglass.  
 Diffuser: Methacrylate.

**Light Source and electronics**  
 2 x LED 2,1 W 700 mA  
 Constant Current 700 mA  
 100~240V 50/60Hz

**Packaging**  
 2 Boxes  
 Total Vol 0,0470 m<sup>3</sup>  
 Gross weight 8,5 Kg Net weight 6 Kg

**Notes**  
 Surface

4802

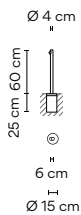

- Finishes**
- 07/ \_\_ Khaki (RAL 7006)
  - 54/ \_\_ Oxide (RAL 8017)
  - 58/ \_\_ Off-white (PANTONE WARM GRAY 2U)

- LED temperature colour**
- /1 \_ 2700 K CRI >90 181,2 lm 86 lm/W
  - /3 \_ 3500 K CRI >90 181,2 lm 86,3 lm/W

**Control**  
 4802 \_\_ / \_ 0 **890,00 €**  
 On/ Off

**Materials**  
 Cane: Resin + fiberglass.  
 Diffuser: Methacrylate.

**Light Source and electronics**  
 1 x LED 2,1 W 700 mA  
 Constant Current 700 mA  
 100~240V 50/60Hz

**Packaging**  
 2 Boxes  
 Total Vol 0,0480 m<sup>3</sup>  
 Gross weight 7 Kg Net weight 5,5 Kg

**Notes**  
 Built-in

4803

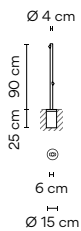

- Finishes**
- 07/ \_\_ Khaki (RAL 7006)
  - 54/ \_\_ Oxide (RAL 8017)
  - 58/ \_\_ Off-white (PANTONE WARM GRAY 2U)

- LED temperature colour**
- /1 \_ 2700 K CRI >90 362,4 lm 86 lm/W
  - /3 \_ 3500 K CRI >90 362,4 lm 86,3 lm/W

**Control**  
 4803 \_\_ / \_ 0 **1.020,00 €**  
 On/ Off

**Materials**  
 Cane: Resin + fiberglass.  
 Diffuser: Methacrylate.

**Light Source and electronics**  
 2 x LED 2,1 W 700 mA  
 Constant Current 700 mA  
 100~240V 50/60Hz

**Packaging**  
 2 Boxes  
 Total Vol 0,0470 m<sup>3</sup>  
 Gross weight 8,5 Kg Net weight 5,8 Kg

**Notes**  
 Built-in

4804

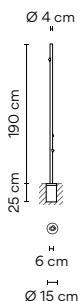

|   |  |   |
|---|--|---|
| <p><b>Finishes</b></p> <ul style="list-style-type: none"> <li>● <b>07/</b> __ Khaki (RAL 7006)</li> <li>● <b>54/</b> __ Oxide (RAL 8017)</li> <li>● <b>58/</b> __ Off-white (PANTONE WARM GRAY 2U)</li> </ul> | <p><b>LED temperature colour</b></p> <p><b>/1_</b> 2700 K  CRI &gt;90 543,7 lm 86 lm/W</p> <p><b>/3_</b> 3500 K  CRI &gt;90 543,7 lm 86,3 lm/W</p>             | <p><b>Control</b></p> <p><b>4804</b> __ / __ <b>0</b><br/>On/ Off</p> <p style="text-align: right;"><b>1.275,00 €</b></p> |
| <p><b>Materials</b></p> <p>Cane: Resin + fiberglass.<br/>Diffuser: Methacrylate.</p> <p><b>Light Source and electronics</b></p> <p>3 x LED 2,1 W 700 mA<br/>Constant Current 700 mA<br/>100~240V 50/60Hz</p>  | <p><b>Packaging</b></p> <p>2 Boxes<br/>Total Vol 0,0480 m<sup>3</sup><br/>Gross weight 8 Kg Net weight 6,5 Kg</p> <p><b>Notes</b></p> <p>Built-in</p> <p> </p> |   |

4805

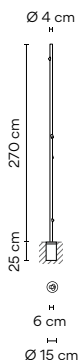

|   |  |   |
|---|--|---|
| <p><b>Finishes</b></p> <ul style="list-style-type: none"> <li>● <b>07/</b> __ Khaki (RAL 7006)</li> <li>● <b>54/</b> __ Oxide (RAL 8017)</li> <li>● <b>58/</b> __ Off-white (PANTONE WARM GRAY 2U)</li> </ul> | <p><b>LED temperature colour</b></p> <p><b>/1_</b> 2700 K  CRI &gt;90 724,9 lm 86 lm/W</p> <p><b>/3_</b> 3500 K  CRI &gt;90 724,9 lm 86,3 lm/W</p>           | <p><b>Control</b></p> <p><b>4805</b> __ / __ <b>0</b><br/>On/ Off</p> <p style="text-align: right;"><b>1.515,00 €</b></p> |
| <p><b>Materials</b></p> <p>Cane: Resin + fiberglass.<br/>Diffuser: Methacrylate.</p> <p><b>Light Source and electronics</b></p> <p>4 x LED 2,1 W 700 mA<br/>Constant Current 700 mA<br/>100~240V 50/60Hz</p>  | <p><b>Packaging</b></p> <p>2 Boxes<br/>Total Vol 0,0600 m<sup>3</sup><br/>Gross weight 9 Kg Net weight 7 Kg</p> <p><b>Notes</b></p> <p>Built-in</p> <p> </p> |   |

4810

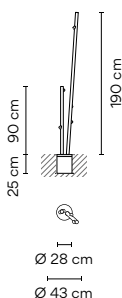

|   |  |   |
|---|--|---|
| <p><b>Finishes</b></p> <ul style="list-style-type: none"> <li>● <b>07/</b> __ Khaki (RAL 7006)</li> <li>● <b>54/</b> __ Oxide (RAL 8017)</li> <li>● <b>58/</b> __ Off-white (PANTONE WARM GRAY 2U)</li> </ul> | <p><b>LED temperature colour</b></p> <p><b>/1_</b> 2700 K  CRI &gt;90 906,1 lm 86 lm/W</p> <p><b>/3_</b> 3500 K  CRI &gt;90 906,1 lm 86,3 lm/W</p>               | <p><b>Control</b></p> <p><b>4810</b> __ / __ <b>0</b><br/>On/ Off</p> <p style="text-align: right;"><b>1.920,00 €</b></p> |
| <p><b>Materials</b></p> <p>Cane: Resin + fiberglass.<br/>Diffuser: Methacrylate.</p> <p><b>Light Source and electronics</b></p> <p>5 x LED 2,1 W 700 mA<br/>Constant Current 700 mA<br/>100~240V 50/60Hz</p>  | <p><b>Packaging</b></p> <p>3 Boxes<br/>Total Vol 0,1388 m<sup>3</sup><br/>Gross weight 15 Kg Net weight 12,5 Kg</p> <p><b>Notes</b></p> <p>Built-in</p> <p> </p> |   |

4811

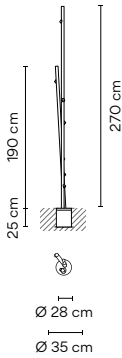

|   |                               |                |            |
|---|-------------------------------|----------------|------------|
| <b>Finishes</b>                           | <b>LED temperature colour</b> | <b>Control</b> |            |
| ● 07/ __ Khaki (RAL 7006)                 | /1_ 2700 K                    | 4811 __ / _ 0  | 2.375,00 € |
| ● 54/ __ Oxide (RAL 8017)                 | /3_ 3500 K                    | On/ Off        |            |
| ● 58/ __ Off-white (PANTONE WARM GRAY 2U) |                               |                |            |

|  |  |
|--|--|
| <b>Materials</b><br>Cane: Resin + fiberglass.<br>Diffuser: Methacrylate.                                   | <b>Packaging</b><br>3 Boxes<br>Total Vol 1,660 m <sup>3</sup><br>Gross weight 16,5 Kg Net weight 13 Kg |
| <b>Light Source and electronics</b><br>7 x LED 2,1 W 700 mA<br>Constant Current 700 mA<br>100~240V 50/60Hz | <b>Notes</b><br>Built-in   |



4812

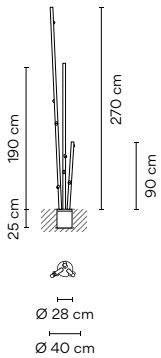

|   |                               |                |            |
|---|-------------------------------|----------------|------------|
| <b>Finishes</b>                           | <b>LED temperature colour</b> | <b>Control</b> |            |
| ● 07/ __ Khaki (RAL 7006)                 | /1_ 2700 K                    | 4812 __ / _ 0  | 2.965,00 € |
| ● 54/ __ Oxide (RAL 8017)                 | /3_ 3500 K                    | On/ Off        |            |
| ● 58/ __ Off-white (PANTONE WARM GRAY 2U) |                               |                |            |

|  |  |
|--|--|
| <b>Materials</b><br>Cane: Resin + fiberglass.<br>Diffuser: Methacrylate.                                   | <b>Packaging</b><br>4 Boxes<br>Total Vol 0,1854 m <sup>3</sup><br>Gross weight 21,6 Kg Net weight 19,44 Kg |
| <b>Light Source and electronics</b><br>9 x LED 2,1 W 700 mA<br>Constant Current 700 mA<br>100~240V 50/60Hz | <b>Notes</b><br>Built-in   |



4820

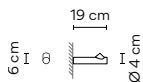

|   |                               |                |          |
|---|-------------------------------|----------------|----------|
| <b>Finishes</b>                           | <b>LED temperature colour</b> | <b>Control</b> |          |
| ● 07/ __ Khaki (RAL 7006)                 | /1_ 2700 K                    | 4820 __ / _ 0  | 410,00 € |
| ● 54/ __ Oxide (RAL 8017)                 | /3_ 3500 K                    | On/ Off        |          |
| ● 58/ __ Off-white (PANTONE WARM GRAY 2U) |                               |                |          |

|  |  |
|--|--|
| <b>Materials</b><br>Cane: Resin + fiberglass.<br>Diffuser: Methacrylate.                                   | <b>Packaging</b><br>1 Box 0,25 x 0,10 x 0,10 m<br>Vol 0,0025 m <sup>3</sup><br>Gross weight 2 Kg Net weight 1 Kg |
| <b>Light Source and electronics</b><br>1 x LED 2,1 W 700 mA<br>Constant Current 700 mA<br>100~240V 50/60Hz | <b>Notes</b><br>Surface  |



# Duo

Design by Ramos & Bassols

Natural warmth. Simple volumes with a sculptural quality, easily integrated with the architecture of the ceilings where they are fitted allowing the lights to become focal points without being suspended.

## Ceiling

4870

∅ 47,5 cm



4872

∅ 78,5 cm



4874

∅ 35 cm



4878

∅ 70 cm



4876

∅ 35 cm



4880

∅ 70 cm



4870

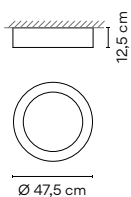

### Finishes

- **18/** \_ \_ Graphite  
(Adapta RF9913WX)
- **58/** \_ \_ Cream  
(RAL 7044)
- **93/** \_ \_ White  
(RAL 9016)

Finish customization  
(Available options:  
Vibia colour palette)

### Materials

Diffuser: Polycarbonate. Main Body: Aluminum.  
Inner structure: Oak wood.

### Light Source and electronics

1 x LED PLATE 26,5 W 700 mA  
Constant Current 700 mA  
110-240V 50/60Hz

### LED temperature colour

- /1\_ 2700 K CRI >90 2207,0 lm 98 lm/W
- /3\_ 3500 K CRI >80 2304 lm 102,30 lm/W
- /4\_ 4000 K CRI >90 2364,6 lm 105,1 lm/W

### Control

- |                       |                   |
|-----------------------|-------------------|
| <b>4870</b> _ _ / _ A | <b>1.465,00 €</b> |
| DALI-2, 1-10V, Push   |                   |
| <b>4870</b> _ _ / _ Z | <b>1.585,00 €</b> |
| Casambi               |                   |

### Packaging

1 Box 0,56 x 0,56 x 0,26 m  
Vol 0,0815 m<sup>3</sup>  
Gross weight 7 Kg Net weight 6 Kg



4872

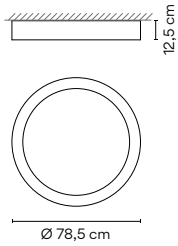

|  |  |
|--|--|
| <b>Finishes</b>                                | <b>LED temperature colour</b>                    |
| ● <b>18/</b> _ _ Graphite<br>(Adapta RF9913WX) | <b>/1</b> _ 2700 K  CRI >90 3959,0 lm 100 lm/W   |
| ● <b>58/</b> _ _ Cream<br>(RAL 7044)           | <b>/3</b> _ 3500 K  CRI >90 4133 lm 104,39 lm/W  |
| ● <b>93/</b> _ _ White<br>(RAL 9016)           | <b>/4</b> _ 4000 K  CRI >90 4241,8 lm 107,3 lm/W |

**Finish customization**  
 (Available options:  
 Vibia colour palette)

**Materials**  
 Diffuser: Polycarbonate. Main Body: Aluminum.  
 Inner structure: Oak wood.

**Light Source and electronics**  
 1 x LED PLATE 50 W 700 mA  
 Constant Current 750 mA  
 110-240V 50/60Hz

|  |                   |
|--|-------------------|
| <b>Control</b>                               |                   |
| <b>4872</b> _ _ / _ A<br>DALI-2, 1-10V, Push | <b>2.240,00 €</b> |
| <b>4872</b> _ _ / _ Z<br>Casambi             | <b>2.360,00 €</b> |

**Packaging**  
 1 Box 0,9 x 0,9 x 0,25 m  
 Vol 0,2025 m<sup>3</sup>  
 Gross weight 19 Kg Net weight 17 Kg

4874

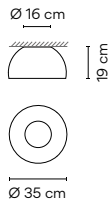

|  |  |
|--|--|
| <b>Finishes</b>                                | <b>LED temperature colour</b>                  |
| ● <b>18/</b> _ _ Graphite<br>(Adapta RF9913WX) | <b>/1</b> _ 2700 K  CRI >90 644,7 lm 54 lm/W   |
| ● <b>58/</b> _ _ Cream<br>(RAL 7044)           | <b>/3</b> _ 3500 K  CRI >90 632 lm 52,6 lm/W   |
| ● <b>93/</b> _ _ White<br>(RAL 9016)           | <b>/4</b> _ 4000 K  CRI >90 690,7 lm 57,6 lm/W |

**Finish customization**  
 (Available options:  
 Vibia colour palette)

**Materials**  
 Diffuser: Polycarbonate. Main Body: Aluminum.  
 Inner structure: Oak wood.

**Light Source and electronics**  
 1 x LED PLATE 12 W 350 mA  
 Constant Current 350 mA  
 110-240V 50/60Hz

|                                      |                   |
|--------------------------------------|-------------------|
| <b>Control</b>                       |                   |
| <b>4874</b> _ _ / _ 1<br>DALI-2      | <b>1.375,00 €</b> |
| <b>4874</b> _ _ / _ B<br>1-10V, Push | <b>1.185,00 €</b> |
| <b>4874</b> _ _ / _ Z<br>Casambi     | <b>1.305,00 €</b> |

**Packaging**  
 1 Box 0,44 x 0,44 x 0,35 m  
 Vol 0,0678 m<sup>3</sup>  
 Gross weight 5 Kg Net weight 4 Kg

4876

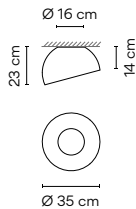

|  |  |
|--|--|
| <b>Finishes</b>                                | <b>LED temperature colour</b>                  |
| ● <b>18/</b> _ _ Graphite<br>(Adapta RF9913WX) | <b>/1</b> _ 2700 K  CRI >90 644,7 lm 54 lm/W   |
| ● <b>58/</b> _ _ Cream<br>(RAL 7044)           | <b>/3</b> _ 3500 K  CRI >90 632 lm 52,6 lm/W   |
| ● <b>93/</b> _ _ White<br>(RAL 9016)           | <b>/4</b> _ 4000 K  CRI >90 690,7 lm 57,6 lm/W |

**Finish customization**  
 (Available options:  
 Vibia colour palette)

**Materials**  
 Diffuser: Polycarbonate. Main Body: Aluminum.  
 Inner structure: Oak wood.

**Light Source and electronics**  
 1 x LED PLATE 12 W 350 mA  
 Constant Current 350 mA  
 110-240V 50/60Hz

|                                      |                   |
|--------------------------------------|-------------------|
| <b>Control</b>                       |                   |
| <b>4876</b> _ _ / _ 1<br>DALI-2      | <b>1.460,00 €</b> |
| <b>4876</b> _ _ / _ B<br>1-10V, Push | <b>1.270,00 €</b> |
| <b>4876</b> _ _ / _ Z<br>Casambi     | <b>1.390,00 €</b> |

**Packaging**  
 1 Box 0,44 x 0,44 x 0,35 m  
 Vol 0,0678 m<sup>3</sup>  
 Gross weight 5 Kg Net weight 4 Kg

4878

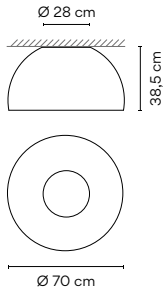

|   |  |  |
|---|--|--|
| <b>Finishes</b>   | <b>LED temperature colour</b>                      | <b>Control</b>   |
| ● <b>18/</b> __ Graphite<br>(Adapta RF9913WX)                               | <b>/1</b> _ 2700 K<br>CRI >90 2207 lm 98 lm/W      | <b>4878</b> __ / _ A <span style="float: right;"><b>1.995,00 €</b></span><br>DALI-2, 1-10V, Push |
| ● <b>58/</b> __ Cream<br>(RAL 7044)   | <b>/3</b> _ 3500 K<br>CRI >90 2304 lm 102,30 lm/   | <b>4878</b> __ / _ Z <span style="float: right;"><b>2.115,00 €</b></span><br>Casambi             |
| ● <b>93/</b> __ White<br>(RAL 9016)   | <b>/4</b> _ 4000 K<br>CRI >90 2364,6 lm 105,1 lm/W |  |
| <b>Finish customization</b><br>(Available options:<br>Vibia colour palette) |  |  |

**Materials**

Diffuser: Polycarbonate. Main Body: Aluminum.  
Inner structure: Oak wood.

**Light Source and electronics**

1 x LED PLATE 26,5 W 700 mA  
Constant Current 350 mA  
110-240V 50/60Hz

**Packaging**

1 Box 0,79 x 0,79 x 0,59 m  
Vol 0,3682 m<sup>3</sup>  
Gross weight 16 Kg Net weight 14 Kg



4880

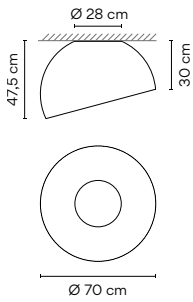

|   |  |  |
|---|--|--|
| <b>Finishes</b>   | <b>LED temperature colour</b>                      | <b>Control</b>   |
| ● <b>18/</b> __ Graphite<br>(Adapta RF9913WX)                               | <b>/1</b> _ 2700 K<br>CRI >90 2207 lm 98 lm/W      | <b>4880</b> __ / _ A <span style="float: right;"><b>2.220,00 €</b></span><br>DALI-2, 1-10V, Push |
| ● <b>58/</b> __ Cream<br>(RAL 7044)   | <b>/3</b> _ 3500 K<br>CRI >90 2304 lm 102,30 lm/W  | <b>4880</b> __ / _ Z <span style="float: right;"><b>2.340,00 €</b></span><br>Casambi             |
| ● <b>93/</b> __ White<br>(RAL 9016)   | <b>/4</b> _ 4000 K<br>CRI >90 2364,6 lm 105,1 lm/W |  |
| <b>Finish customization</b><br>(Available options:<br>Vibia colour palette) |  |  |

**Materials**

Diffuser: Polycarbonate. Main Body: Aluminum.  
Inner structure: Oak wood.

**Light Source and electronics**

1 x LED PLATE 26,5 W 700 mA  
Constant Current 350 mA  
110-240V 50/60Hz

**Packaging**

1 Box 0,79 x 0,79 x 0,59 m  
Vol 0,3682 m<sup>3</sup>  
Gross weight 16 Kg Net weight 14 Kg













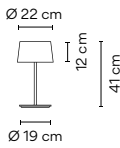

# Warm

Design by Ramos & Bassols

Offering a contemporary take on a timeless design, Warm features a generously sized, classic drum shade, with a carefully selected colour palette that provides a contemporary touch.

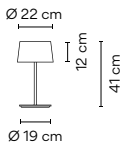
## Table



|  |   |  |
|--|---|--|
| <p><b>4895</b></p>  | <p><b>Finishes</b></p> <ul style="list-style-type: none"> <li>● <b>10 White</b> (NCS S 0300-N)</li> </ul> <p>LED 2700 K 470 lm</p> <hr/> <p><b>Materials</b><br/>Shade: Screen. Diffuser: Methacrylate.<br/>Rod: Aluminum. Base: Steel.</p> <p><b>Light Source and electronics</b><br/>3 x LED G9 230V 3,8 W</p>  | <p><b>4895 10</b> <b>425,00 €</b></p> <hr/> <p><b>Packaging</b><br/>2 Boxes<br/>Total Vol 0,0390 m<sup>3</sup><br/>Gross weight 2,9 Kg Net weight 1,3 Kg</p> <p><b>Notes</b><br/>On/off switch on the cable.<br/>Electric cable 2 m</p> <p>     </p> |
| <p><b>4896</b></p>  | <p><b>Finishes</b></p> <ul style="list-style-type: none"> <li>● <b>10 White</b> (NCS S 0300-N)</li> <li>● <b>25 Beige D1</b> (NCS S 4005-Y50R)</li> <li>● <b>28 Brown M1</b> (NCS S 4020-Y60R)</li> <li>● <b>56 Green D1</b> (NCS S 7010-G30Y)</li> </ul> <p>LED 2700 K 470 lm</p> <hr/> <p><b>Finish customization</b><br/>(Available options:<br/>Vibia colour palette)</p> <p><b>Materials</b><br/>Shade: Aluminum. Diffuser: Methacrylate.<br/>Rod: Aluminum. Base: Steel.</p> <p><b>Light Source and electronics</b><br/>3 x LED G9 230V 3,8 W</p> | <p><b>4896 _ _</b> <b>430,00 €</b></p> <hr/> <p><b>Packaging</b><br/>2 Boxes<br/>Total Vol 0,0390 m<sup>3</sup><br/>Gross weight 2,9 Kg Net weight 2 Kg</p> <p><b>Notes</b><br/>On/off switch on the cable.<br/>Electric cable 2 m</p> <p>     </p>  |



## 4900

## Finishes

10 White  
(NCS S 0300-N)

LED 2700 K 1520 lm

4900 10

650,00 €

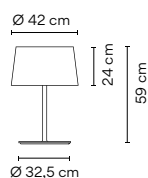

## Materials

Shade: Screen. Diffuser: Methacrylate.  
Rod: Aluminum. Base: Steel.

## Light Source and electronics

3 x LED E27 230V 12 W

## Packaging

2 Boxes  
Total Vol 0,2153 m<sup>3</sup>  
Gross weight 4,3 Kg Net weight 3,8 Kg

## Notes

On/off switch on the cable.  
Electric cable 2 m



## 4901

## Finishes

10 White  
(NCS S 0300-N)  
25 Beige D1  
(NCS S 4005-Y50R)  
28 Brown M1  
(NCS S 4020-Y60R)  
56 Green D1  
(NCS S 7010-G30Y)

LED 2700 K 1520 lm

4901 \_\_

690,00 €

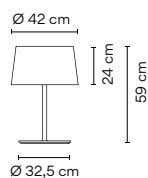

## Materials

Shade: Aluminum. Diffuser: Methacrylate.  
Rod: Aluminum. Base: Steel.

## Light Source and electronics

3 x LED E27 230V 12 W

## Packaging

2 Boxes  
Total Vol 0,2153 m<sup>3</sup>  
Gross weight 4,8 Kg Net weight 4,3 Kg

## Notes

On/off switch on the cable.  
Electric cable 2 m



Warm

---

Floor



4905 4906

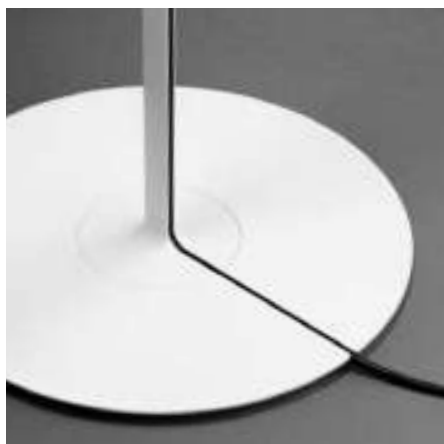

4905

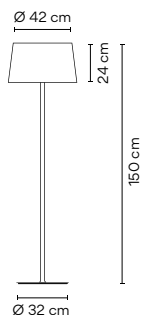

Finishes  
 ● **10 White** (NCS S 0300-N) LED 2700 K 1520 lm **4905 10** **780,00 €**

Materials

Shade: Screen. Diffuser: Methacrylate.  
 Rod: Aluminum. Base: Steel.

Light Source and electronics  
 3 x LED E27 230V 12 W

Packaging

2 Boxes  
 Total Vol 0,3426 m<sup>3</sup>  
 Gross weight 10,2 Kg Net weight 6,3 Kg

Notes

On/off switch on the cable.  
 Electric cable 2,5 m



4906

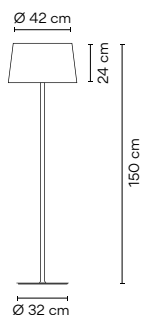

Finishes  
 ● **10 White** (NCS S 0300-N) LED 2700 K 1520 lm **4906 \_ \_** **825,00 €**  
 ● **25 Beige D1** (NCS S 4005-Y50R)  
 ● **28 Brown M1** (NCS S 4020-Y60R)  
 ● **56 Green D1** (NCS S 7010-G30Y)

Finish customization  
 (Available options:  
 Vibia colour palette)

Materials

Shade: Aluminum. Diffuser: Methacrylate.  
 Rod: Aluminum. Base: Steel.

Light Source and electronics  
 3 x LED E27 230V 12 W

Packaging

2 Boxes  
 Total Vol 0,3426 m<sup>3</sup>  
 Gross weight 10,7 Kg Net weight 6,8 Kg

Notes

On/off switch on the cable.  
 Electric cable 2,5 m



---

Pendants

4925 4926

4930

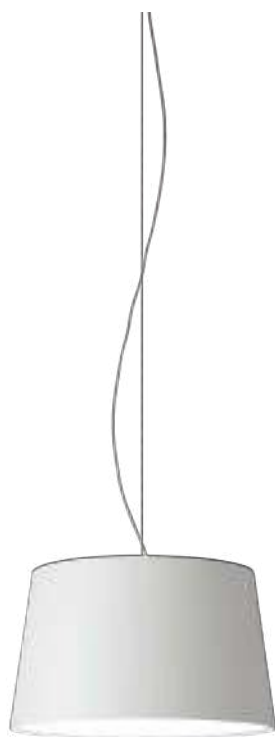

ø 62 cm



ø 90 cm



4925

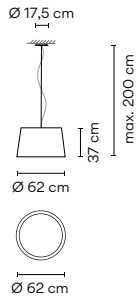

## Finishes

- **10 White**  
(NCS S 0300-N)

LED 2700 K 1520 lm

4925 10

835,00 €

## Materials

Shade: Screen. Canopy: Steel.  
Diffuser: Methacrylate.

Light Source and electronics  
4 x LED E27 230V 12 W

## Packaging

1 Box 0,68 x 0,68 x 0,39 m  
Vol 0,18 m<sup>3</sup>  
Gross weight 7,7 Kg Net weight 3,9 Kg

## Notes

Extra cable length. 16,00 €/m



4926

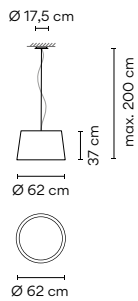

## Finishes

- **10 White**  
(NCS S 0300-N)
- **25 Beige D1**  
(NCS S 4005-Y50R)
- **28 Brown M1**  
(NCS S 4020-Y60R)
- **56 Green D1**  
(NCS S 7010-G30Y)

LED 2700 K 1520 lm

4926 --

860,00 €

Finish customization  
(Available options:  
Vibia colour palette)

## Materials

Shade: Aluminum. Canopy: Steel.  
Diffuser: Methacrylate.

Light Source and electronics  
4 x LED E27 230V 12 W

## Packaging

1 Box 0,77 x 0,77 x 0,50 m  
Vol 0,2965 m<sup>3</sup>  
Gross weight 8,9 Kg Net weight 5,1 Kg

## Notes

Extra cable length. 16,00 €/m



4930

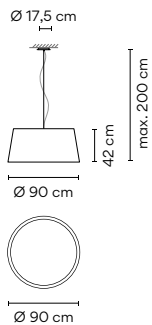

## Finishes

- **10 White**  
(NCS S 0300-N)

LED 2700 K 1520 lm

4930 10

1.490,00 €

## Materials

Shade: Screen. Canopy: Steel.  
Diffuser: Methacrylate.

Light Source and electronics  
4 x LED E27 230V 12 W

## Packaging

1 Box 1,58 x 0,86 x 1,58 m  
Vol 2,1469 m<sup>3</sup>  
Gross weight 11,7 Kg Net weight 10,8 Kg

## Notes

Extra cable length. 16,00 €/m

**UNTIL STOCK RUNS OUT**



# Ghost

Design by Arik Levy

A study in contrasts, the Ghost collection embodies both spirit and materiality, discretion and presence. A contemporary reimagining of the grand lights that once graced entryways and living areas, its sensuous form radiates a welcoming, luminous sensitivity.

## Table



Ø 47,5 cm

**4960**



Ø 47,5 cm

**4965**



Ø 47,5 cm

**4970**

A colour glass diffuser can be placed in the lower glass for an amber or burgundy light effect





## Dimming and installation options



/15: Push-dimming model equipped with two buttons, one for each diffuser. A quick push turns the light on and off, a longer presson dims the light.

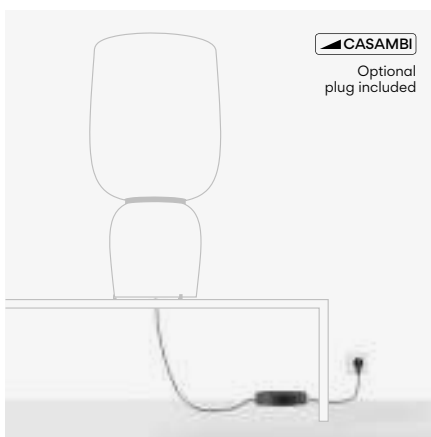
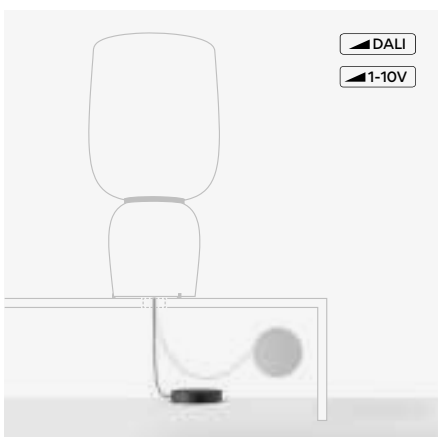

Dimming and installation options: The driver of the DALI, 1-10V and Casambi versions is enclosed in a box at the end of the cable.

### 4960

Finishes  
 ● 11/ \_\_ Black  
 (NCS S 8500-N)

LED temperature colour  
 /1\_ 2700 K   
 CRI >90 5432,0 lm 137 lm/W

| Control                  | Price      |
|--------------------------|------------|
| 4960 __ / _ 1<br>DALI    | 2.480,00 € |
| 4960 __ / _ 3<br>1-10V   | 2.480,00 € |
| 4960 __ / _ 5<br>Push    | 2.360,00 € |
| 4960 __ / _ Z<br>Casambi | 2.480,00 € |

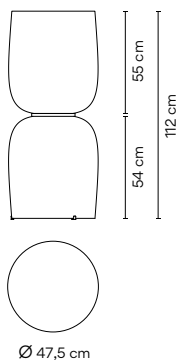

Materials  
 Diffuser: Opal Glass.  
 Metal parts: Aluminum.

Light Source and electronics  
 2 x LED 19,8 W 800 mA  
 Constant Current 800 mA  
 100~240V 50/60Hz

Packaging  
 2 Boxes  
 Total Vol 0,6051 m<sup>3</sup>  
 Gross weight 25,7 Kg Net weight 22,7 Kg

Notes  
 A colour glass diffuser can be placed in the lower glass for an amber or burgundy light effect. Electric cable 2 m.  
 Extra cable length. 16,00 €/m

LED IP20 CE Dimmer Bi-volt

4965

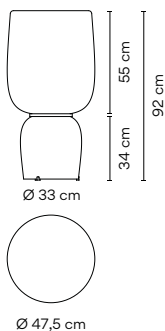

Finishes  
 ● 11/ \_\_ Black  
 (NCS S 8500-N)

LED temperature colour  
 /1\_ 2700 K   
 CRI >90 5432,0 lm 137 lm/W

|                          |            |
|--------------------------|------------|
| Control                  |            |
| 4965 __ / _ 1<br>DALI    | 2.145,00 € |
| 4965 __ / _ 3<br>1-10V   | 2.145,00 € |
| 4965 __ / _ 5<br>Push    | 2.040,00 € |
| 4965 __ / _ Z<br>Casambi | 2.160,00 € |

Materials  
 Diffuser: Opal Glass.  
 Metal parts: Aluminum.

Light Source and electronics  
 2 x LED 19,8 W 800 mA  
 Constant Current 800 mA  
 100~240V 50/60Hz

Packaging  
 2 Boxes  
 Total Vol 0,6051 m<sup>3</sup>  
 Gross weight 20,6 Kg Net weight 17,6 Kg

Notes  
 A colour glass diffuser can be placed in the lower glass for an amber or burgundy light effect. Electric cable 2 m.  
 Extra cable length. 16,00 €/m

4970

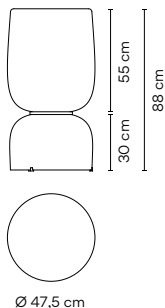

Finishes  
 ● 11/ \_\_ Black  
 (NCS S 8500-N)

LED temperature colour  
 /1\_ 2700 K   
 CRI >90 5432,0 lm 137 lm/W

|                          |            |
|--------------------------|------------|
| Control                  |            |
| 4970 __ / _ 1<br>DALI    | 2.190,00 € |
| 4970 __ / _ 3<br>1-10V   | 2.190,00 € |
| 4970 __ / _ 5<br>Push    | 2.085,00 € |
| 4970 __ / _ Z<br>Casambi | 2.205,00 € |

Materials  
 Diffuser: Opal Glass.  
 Metal parts: Aluminum.

Light Source and electronics  
 2 x LED 19,8 W 800 mA  
 Constant Current 800 mA  
 100~240V 50/60Hz

Packaging  
 2 Boxes  
 Total Vol 0,6051 m<sup>3</sup>  
 Gross weight 21,7 Kg Net weight 18,7 Kg

Notes  
 A colour glass diffuser can be placed in the lower glass for an amber or burgundy light effect. Electric cable 2 m.  
 Extra cable length. 16,00 €/m

## Pendants



**4987**

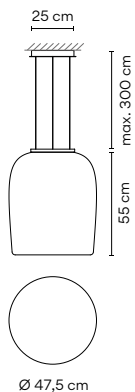

**Finishes**  
 ● **11/ \_ \_ Black**  
 (NCS S 8500-N)

**LED temperature colour**  
 /1\_ 2700 K **D**  
 CRI >90 4826,7 lm 130 lm/W

**Control**

|  |                   |
|--|-------------------|
| <b>4987 _ _ / _ A</b><br>DALI-2, 1-10V, Push | <b>1.620,00 €</b> |
| <b>4987 _ _ / _ Z</b><br>Casambi             | <b>1.740,00 €</b> |

**Materials**  
 Diffuser: Opal Glass.  
 Metal parts: Aluminum.

**Light Source and electronics**  
 1 x LED 37,2 W 1050 mA  
 Constant Current 1050 mA  
 100~240V 50/60Hz

**Packaging**  
 1 Box 0,61 x 0,62 x 0,80 m  
 Vol 0,3026 m<sup>3</sup>  
 Gross weight 13,9 Kg Net weight 12,4 Kg  
 Extra cable length. **16,00 €/m**

# Balance

Design by Jordi Vilardell

Balance features a classic drum shade cantilevered from its column. Adjusting a small pull cord on the diffuser activates the fixture's counterweight system, enabling it to move to the right or left, or up or down-all the while remaining parallel to the floor.

## Floor



210 x 260 cm

5189 5190



210 x 215 cm

5191 5192

5189

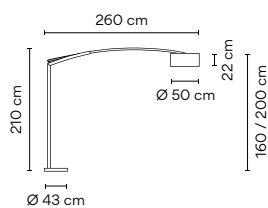

### Finishes

- 01 Chrome (Metallic finish)
- 18 Graphite (RAL 7016)
- 30 Nickel (Metallic finish)

### Materials

Vertical tube: Aluminum. Base: Steel.  
Arm: Inox. Shade: Grey fabric.

### Light Source and electronics

LED 2700K 1520 lm Dim  
3 x E27 230V 12 W

### Control

5189 --  
Push

2.765,00 €

### Packaging

3 Boxes  
Total Vol 0,3472 m<sup>3</sup>  
Gross weight 53,8 Kg Net weight 49,5 Kg

### Notes

Dimmer on the cable. 3 m



5190

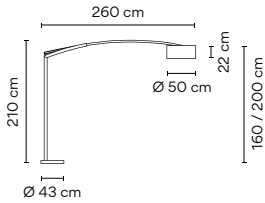

Finishes

- 01 Chrome (Metallic finish)
- 18 Graphite (RAL 7016)
- 30 Nickel (Metallic finish)

Materials

Vertical tube: Aluminum. Base: Steel.  
Arm: Inox. Shade: Parchment.

Light Source and electronics

LED 2700K 1520 lm Dim  
3 x E27 230V 12 W

Control

5190 \_ \_  
Push

2.765,00 €

Packaging

3 Boxes  
Total Vol 0,3472 m<sup>3</sup>  
Gross weight 53,8 Kg Net weight 49,5 Kg

Notes

Dimmer on the cable. 3 m

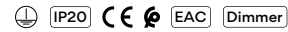

5191

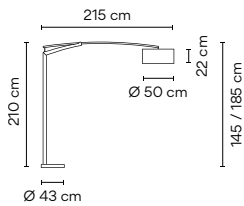

Finishes

- 01 Chrome (Metallic finish)
- 30 Nickel (Metallic finish)

Materials

Vertical tube: Aluminum. Base: Steel.  
Arm: Inox. Shade: Parchment.

Light Source and electronics

LED 2700K 1520 lm Dim  
3 x E27 230V 12 W

Control

5191 \_ \_  
Push

2.685,00 €

Packaging

3 Boxes  
Total Vol 0,3472 m<sup>3</sup>  
Gross weight 53,8 Kg Net weight 49,1 Kg

Notes

Dimmer on the cable. 3 m



5192

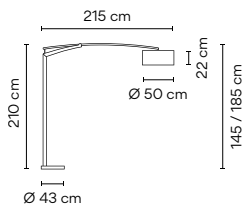

Finishes

- 01 Chrome (Metallic finish)
- 18 Graphite (RAL 7016)
- 30 Nickel (Metallic finish)

Materials

Vertical tube: Aluminum. Base: Steel.  
Arm: Inox. Shade: Grey fabric.

Light Source and electronics

LED 2700K 1520 lm Dim  
3 x E27 230V 12 W

Control

5192 \_ \_  
Push

2.685,00 €

Packaging

3 Boxes  
Total Vol 0,3472 m<sup>3</sup>  
Gross weight 53,8 Kg Net weight 49,1 Kg

Notes

Dimmer on the cable. 3 m



# Puck

Design by Jordi Vilardell

Inspired by the classic circle silhouette, Puck panel light's simple, spherical forms can be superimposed on one another, lending sensibility overhead. Crafted of premium, opal triplex blown glass, it casts a warm glow.

## Ceiling Wall



16 cm

**5400 5402**



24,4 cm

**5410**



27,2 cm

**5412**



31,8 cm

**5425 5427**



46,7 cm

**5430 5432**



56,8 cm

**5435 5437**



53,2 cm

**5440 5442**



79 cm

**5445 5447**

**5400**

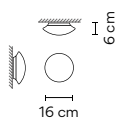

Finishes  
● **03 White**  
(RAL 9016)

Materials  
Canopy: Aluminum.  
Diffuser: Blown-glass.

Light Source and electronics  
1 x LED G9 4,2 W

LED temperature colour  
2700 K 470 lm

**5400 03** 155,00 €

Packaging  
1 Box 0,26 x 0,26 x 0,26 m  
Vol 0,0175 m<sup>3</sup>  
Gross weight 0,85 Kg Net weight 0,6 Kg

Notes  
**UNTIL STOCK RUNS OUT**



|             |                                      |  |                                  |                 |
|-------------|--------------------------------------|--|----------------------------------|-----------------|
| <b>5402</b> | Finishes                             | LED temperature colour   | Control                          |                 |
|             | ● <b>03/ _ _ White</b><br>(RAL 9016) | <b>/1_ 2700 K</b> <br>CRI >90 415,7 lm 130 lm/W | <b>5402 _ _ / _ 0</b><br>On/ Off | <b>195,00 €</b> |

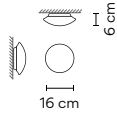

**Materials**

Canopy: Aluminum.  
Diffuser: Blown-glass.

**Light Source and electronics**

1 x LED PLATE 3,2 W 350 mA  
Constant Current 350 mA  
100~240V 50/60Hz

**Packaging**

1 Box 0,26 x 0,26 x 0,26 m  
Vol 0,0175 m<sup>3</sup>  
Gross weight 0,85 Kg Net weight 0,6 Kg

**Notes**

**UNTIL STOCK RUNS OUT**



|             |                                 |                        |                |                 |
|-------------|---------------------------------|------------------------|----------------|-----------------|
| <b>5410</b> | Finishes                        | LED temperature colour | Control        |                 |
|             | ● <b>03 White</b><br>(RAL 9016) | <b>2700 K 470 lm</b>   | <b>5410 03</b> | <b>180,00 €</b> |

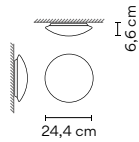

**Materials**

Canopy: Aluminum.  
Diffuser: Blown-glass.

**Light Source and electronics**

2 x LED G9 4,2 W

**Packaging**

1 Box 0,37 x 0,37 x 0,23 m  
Vol 0,0315 m<sup>3</sup>  
Gross weight 0,95 Kg Net weight 0,7 Kg



|             |                                      |  |                                  |                 |
|-------------|--------------------------------------|--|----------------------------------|-----------------|
| <b>5412</b> | Finishes                             | LED temperature colour   | Control                          |                 |
|             | ● <b>03/ _ _ White</b><br>(RAL 9016) | <b>/1_ 2700 K</b> <br>CRI >90 880,1 lm 116 lm/W | <b>5412 _ _ / _ 0</b><br>On/ Off | <b>290,00 €</b> |

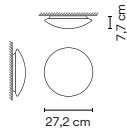

**Materials**

Canopy: Aluminum.  
Diffuser: Blown-glass.

**Light Source and electronics**

1 x LED PLATE 7,6 W 350 mA  
Constant Current 350 mA  
100~240V 50/60Hz

**Packaging**

1 Box 0,37 x 0,37 x 0,23 m  
Vol 0,0315 m<sup>3</sup>  
Gross weight 0,95 Kg Net weight 0,7 Kg



|             |                                 |                        |                |                 |
|-------------|---------------------------------|------------------------|----------------|-----------------|
| <b>5425</b> | Finishes                        | LED temperature colour | Control        |                 |
|             | ● <b>03 White</b><br>(RAL 9016) | <b>2700 K 470 lm</b>   | <b>5425 03</b> | <b>270,00 €</b> |

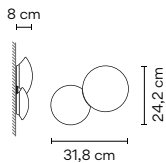

**Materials**

Canopy: Aluminum.  
Diffuser: Blown-glass.

**Light Source and electronics**

2 x LED G9 4,2 W

**Packaging**

1 Box 0,25 x 0,42 x 0,42 m  
Vol 0,0441 m<sup>3</sup>  
Gross weight 2,26 Kg Net weight 1,08 Kg

**Notes**

All version require only one electrical connection



|             |                                      |  |                                  |                 |
|-------------|--------------------------------------|--|----------------------------------|-----------------|
| <b>5427</b> | Finishes                             | LED temperature colour   | Control                          |                 |
|             | ● <b>03/ _ _ White</b><br>(RAL 9016) | <b>/1_ 2700 K</b> <br>CRI >90 831,4 lm 130 lm/W | <b>5427 _ _ / _ 0</b><br>On/ Off | <b>395,00 €</b> |

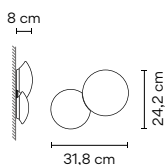

**Materials**

Canopy: Aluminum.  
Diffuser: Blown-glass.

**Light Source and electronics**

2 x LED PLATE 3,2 W 350 mA  
Constant Current 350 mA  
100~240V 50/60Hz

**Packaging**

1 Box 0,25 x 0,42 x 0,42 m  
Vol 0,0441 m<sup>3</sup>  
Gross weight 2,26 Kg Net weight 1,08 Kg

**Notes**

All version require only one electrical connection



|             |                                 |                        |                |                 |
|-------------|---------------------------------|------------------------|----------------|-----------------|
| <b>5430</b> | Finishes                        | LED temperature colour |                |                 |
|             | ● <b>03</b> White<br>(RAL 9016) | 2700 K 470 lm          | <b>5430 03</b> | <b>350,00 €</b> |

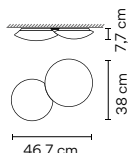

**Materials**  
Canopy: Aluminum.  
Diffuser: Blown-glass.

**Light Source and electronics**  
2 x LED G9 4,2 W

**Packaging**  
1 Box 0,27 x 0,60 x 0,60 m  
Vol 0,0972 m<sup>3</sup>  
Gross weight 4,2 Kg Net weight 2,15 Kg

**Notes**  
All version require only one electrical connection



|             |                                      |  |                                  |                 |
|-------------|--------------------------------------|--|----------------------------------|-----------------|
| <b>5432</b> | Finishes                             | LED temperature colour                   | Control                          |                 |
|             | ● <b>03/ _ _</b> White<br>(RAL 9016) | /1_ 2700 K<br>CRI >90 1760,2 lm 116 lm/W | <b>5432 _ _ / _ 0</b><br>On/ Off | <b>580,00 €</b> |

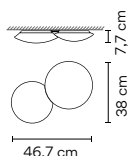

**Materials**  
Canopy: Aluminum.  
Diffuser: Blown-glass.

**Light Source and electronics**  
2 x LED PLATE 7,6 W 350 mA  
Constant Current 350 mA  
100~240V 50/60Hz

**Packaging**  
1 Box 0,27 x 0,60 x 0,60 m  
Vol 0,0972 m<sup>3</sup>  
Gross weight 4,2 Kg Net weight 2,15 Kg

**Notes**  
All version require only one electrical connection



|             |                                 |                        |                |                 |
|-------------|---------------------------------|------------------------|----------------|-----------------|
| <b>5435</b> | Finishes                        | LED temperature colour |                |                 |
|             | ● <b>03</b> White<br>(RAL 9016) | 2700 K 470 lm          | <b>5435 03</b> | <b>580,00 €</b> |

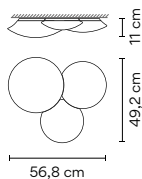

**Materials**  
Canopy: Aluminum.  
Diffuser: Blown-glass.

**Light Source and electronics**  
3 x LED G9 4,2 W

**Packaging**  
2 Boxes  
Total Vol 0,0780 m<sup>3</sup>  
Gross weight 7,5 Kg Net weight 4,1 Kg

**Notes**  
All version require only one electrical connection



|             |                                      |  |                                  |                 |
|-------------|--------------------------------------|--|----------------------------------|-----------------|
| <b>5437</b> | Finishes                             | LED temperature colour                   | Control                          |                 |
|             | ● <b>03/ _ _</b> White<br>(RAL 9016) | /1_ 2700 K<br>CRI >90 2640,4 lm 116 lm/W | <b>5437 _ _ / _ 0</b><br>On/ Off | <b>870,00 €</b> |

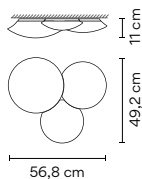

**Materials**  
Canopy: Aluminum.  
Diffuser: Blown-glass.

**Light Source and electronics**  
3 x LED PLATE 7,6 W 350 mA  
Constant Current 350 mA  
100~240V 50/60Hz

**Packaging**  
2 Boxes  
Total Vol 0,0780 m<sup>3</sup>  
Gross weight 7,5 Kg Net weight 4,1 Kg

**Notes**  
All version require only one electrical connection





5440

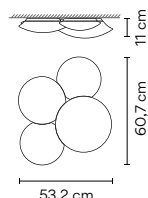

|                       |                        |         |          |
|-----------------------|------------------------|---------|----------|
| Finishes              | LED temperature colour |         |          |
| ● 03 White (RAL 9016) | 2700 K 470 lm          | 5440 03 | 735,00 € |

**Materials**  
 Canopy: Aluminum.  
 Diffuser: Blown-glass.

**Light Source and electronics**  
 2 x LED G9 4,2 W

**Packaging**  
 2 Boxes  
 Total Vol 0,1060 m<sup>3</sup>  
 Gross weight 7,8 Kg Net weight 4,57 Kg

**Notes**  
 All version require only one electrical connection.

**UNTIL STOCK RUNS OUT**



5442

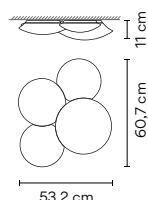

|                           |  |                          |            |
|---------------------------|--|--------------------------|------------|
| Finishes                  | LED temperature colour                 | Control                  |            |
| ● 03/ __ White (RAL 9016) | /1_ 2700 K  CRI >90 3520,5 lm 116 lm/W | 5442 __ / _ 0<br>On/ Off | 1.160,00 € |

**Materials**  
 Canopy: Aluminum.  
 Diffuser: Blown-glass.

**Light Source and electronics**  
 4 x LED PLATE 7,6 W 350 mA  
 Constant Current 350 mA  
 100~240V 50/60Hz

**Packaging**  
 2 Boxes  
 Total Vol 0,1060 m<sup>3</sup>  
 Gross weight 7,8 Kg Net weight 4,57 Kg

**Notes**  
 All version require only one electrical connection.

**UNTIL STOCK RUNS OUT**



5445

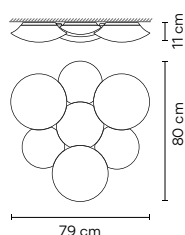

|                       |                        |         |            |
|-----------------------|------------------------|---------|------------|
| Finishes              | LED temperature colour |         |            |
| ● 03 White (RAL 9016) | 2700 K 470 lm          | 5445 03 | 1.185,00 € |

**Materials**  
 Canopy: Aluminum.  
 Diffuser: Blown-glass.

**Light Source and electronics**  
 7 x LED G9 4,2 W

**Packaging**  
 2 Boxes  
 Total Vol 0,19 m<sup>3</sup>  
 Gross weight 12,5 Kg Net weight 8,84 Kg

**Notes**  
 All version require only one electrical connection.

**UNTIL STOCK RUNS OUT**



5447

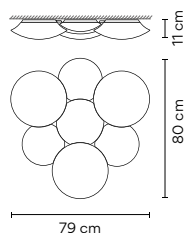

|                           |  |                          |            |
|---------------------------|--|--------------------------|------------|
| Finishes                  | LED temperature colour                 | Control                  |            |
| ● 03/ __ White (RAL 9016) | /1_ 2700 K  CRI >90 6160,8 lm 116 lm/W | 5447 __ / _ 0<br>On/ Off | 2.030,00 € |

**Materials**  
 Canopy: Aluminum.  
 Diffuser: Blown-glass.

**Light Source and electronics**  
 7 x LED PLATE 7,6 W 350 mA  
 Constant Current 350 mA  
 100~240V 50/60Hz

**Packaging**  
 2 Boxes  
 Total Vol 0,19 m<sup>3</sup>  
 Gross weight 12,5 Kg Net weight 8,84 Kg

**Notes**  
 All version require only one electrical connection.

**UNTIL STOCK RUNS OUT**



# Puck Wall Art

Design by Jordi Vilardell

Puck Wall Art is comprised of different disks to create a warm, visually sharp and mathematically creative effect. There are four sizes of disks, allowing the designer to play with varied combinations of indirect light. The resulting design comprises a set of highly dynamic, sculptural compositions.

## Wall



ø 30 cm

**5470**



ø 40 cm

**5471**



ø 45 cm

**5472**



ø 46 cm

**5474**



ø 60 cm

**5476**



58 cm

**5480**



69 cm

**5481**



68 cm

**5485**



87 cm

**5487**



87 cm

**5486**



103 cm

**5491**

Each project is unique.  
 Personalise your own  
 Puck Wall Art composition  
 quick and easy.

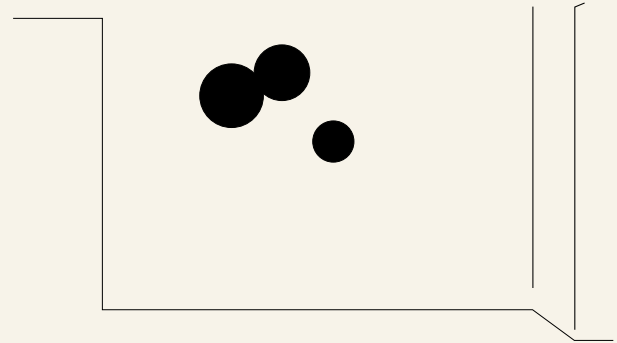

5470

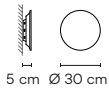

| Finishes                               | LED temperature colour                     | Control                  |          |
|--|--|--------------------------|----------|
| ● 15/ __ Grey L2<br>(NCS S 2500-N)     | /1_ 2700 K<br>CRI >90 952,5 lm 113 lm/W    | 5470 __ / _ 1<br>DALI-2  | 445,00 € |
| ● 21/ __ Black Grey<br>(NCS S 7000-N)  | /3_ 3500 K<br>CRI >90 1017,4 lm 121,1 lm/W | 5470 __ / _ 3<br>1-10V   | 420,00 € |
| ● 28/ __ Brown M1<br>(NCS S 4020-Y60R) |  | 5470 __ / _ 4<br>Triac   | 445,00 € |
|  |  | 5470 __ / _ 5<br>Push    | 445,00 € |
|  |  | 5470 __ / _ Z<br>Casambi | 540,00 € |

| Finishes              | LED temperature colour                     | Control                  |          |
|-----------------------|--|--------------------------|----------|
| ● 76/ __ Grey Felt L1 | /1_ 2700 K<br>CRI >90 952,5 lm 113 lm/W    | 5470 __ / _ 1<br>DALI-2  | 500,00 € |
| ● 77/ __ Grey Felt D1 | /3_ 3500 K<br>CRI >90 1017,4 lm 121,1 lm/W | 5470 __ / _ 3<br>1-10V   | 475,00 € |
|                       |  | 5470 __ / _ 4<br>Triac   | 500,00 € |
|                       |  | 5470 __ / _ 5<br>Push    | 500,00 € |
|                       |  | 5470 __ / _ Z<br>Casambi | 595,00 € |

Materials

Diffuser: Polycarbonate. Shade: ABS.  
 Wall support: Aluminum.

Light Source and electronics

1 x LED STRIP 8,4 W 700 mA  
 Constant Current 700 mA  
 / \_ 1 110~240V 50/60Hz Bi-volt  
 / \_ 3 110~240V 50/60Hz Bi-volt  
 / \_ 5 110~240V 50/60Hz Bi-volt  
 / \_ 4 220~240V 50/60Hz  
 / \_ Z 220~240V 50/60Hz

Packaging

1 Box 0,34 x 0,34 x 0,23 m  
 Vol 0,0266 m<sup>3</sup>  
 Gross weight 2,6 Kg Net weight 1,6 Kg

Notes

A maximum of 8 modules can be connected to a single connection point. For bigger compositions, check connection system

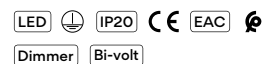

5471

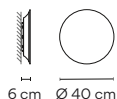

| Finishes                                      | LED temperature colour                             | Control                                |                 |
|---|--|--|-----------------|
| ● <b>15/</b> __ Grey L2<br>(NCS S 2500-N)     | <b>/1</b> _ 2700 K<br>CRI >90 1435,9 lm 114 lm/W   | <b>5471</b> __ / _ <b>1</b><br>DALI-2  | <b>535,00 €</b> |
| ● <b>21/</b> __ Black Grey<br>(NCS S 7000-N)  | <b>/3</b> _ 3500 K<br>CRI >90 1533,8 lm 121,7 lm/W | <b>5471</b> __ / _ <b>3</b><br>1-10V   | <b>505,00 €</b> |
| ● <b>28/</b> __ Brown M1<br>(NCS S 4020-Y6OR) |  | <b>5471</b> __ / _ <b>4</b><br>Triac   | <b>535,00 €</b> |
|   |  | <b>5471</b> __ / _ <b>5</b><br>Push    | <b>535,00 €</b> |
|   |  | <b>5471</b> __ / _ <b>Z</b><br>Casambi | <b>625,00 €</b> |

| Finishes                     | LED temperature colour                             | Control                                |                 |
|------------------------------|--|--|-----------------|
| ● <b>76/</b> __ Grey Felt L1 | <b>/1</b> _ 2700 K<br>CRI >90 1435,9 lm 114 lm/W   | <b>5471</b> __ / _ <b>1</b><br>DALI-2  | <b>590,00 €</b> |
| ● <b>77/</b> __ Grey Felt D1 | <b>/3</b> _ 3500 K<br>CRI >90 1533,8 lm 121,7 lm/W | <b>5471</b> __ / _ <b>3</b><br>1-10V   | <b>560,00 €</b> |
|                              |  | <b>5471</b> __ / _ <b>4</b><br>Triac   | <b>590,00 €</b> |
|                              |  | <b>5471</b> __ / _ <b>5</b><br>Push    | <b>590,00 €</b> |
|                              |  | <b>5471</b> __ / _ <b>Z</b><br>Casambi | <b>680,00 €</b> |

**Materials**

Diffuser: Polycarbonate. Shade: ABS.  
Wall support: Aluminum.

**Light Source and electronics**

1 x LED STRIP 12,6 W 700 mA  
Constant Current 700 mA  
/ \_ **1** 110~240V 50/60Hz Bi-volt  
/ \_ **3** 110~240V 50/60Hz Bi-volt  
/ \_ **5** 110~240V 50/60Hz Bi-volt  
/ \_ **4** 220~240V 50/60Hz  
/ \_ **Z** 220~240V 50/60Hz

**Packaging**

1 Box 0,44 x 0,44 x 0,25 m  
Vol 0,0484 m<sup>3</sup>  
Gross weight 3,5 Kg Net weight 1,9 Kg

**Notes**

A maximum of 8 modules can be connected to a single connection point. For bigger compositions, check connection system

LED IP20 Bi-volt

5472

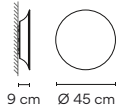

| Finishes                               | LED temperature colour                     | Control                  |          |
|--|--|--------------------------|----------|
| ● 15/ __ Grey L2<br>(NCS S 2500-N)     | /1_ 2700 K<br>CRI >90 1435,9 lm 114 lm/W   | 5472 __ / _ 1<br>DALI-2  | 555,00 € |
| ● 21/ __ Black Grey<br>(NCS S 7000-N)  | /3_ 3500 K<br>CRI >90 1533,8 lm 121,7 lm/W | 5472 __ / _ 3<br>1-10V   | 525,00 € |
| ● 28/ __ Brown M1<br>(NCS S 4020-Y60R) |  | 5472 __ / _ 4<br>Triac   | 555,00 € |
|  |  | 5472 __ / _ 5<br>Push    | 555,00 € |
|  |  | 5471 __ / _ Z<br>Casambi | 645,00 € |

| Finishes              | LED temperature colour                     | Control                  |          |
|-----------------------|--|--------------------------|----------|
| ● 76/ __ Grey Felt L1 | /1_ 2700 K<br>CRI >90 1435,9 lm 114 lm/W   | 5472 __ / _ 1<br>DALI-2  | 610,00 € |
| ● 77/ __ Grey Felt D1 | /3_ 3500 K<br>CRI >90 1533,8 lm 121,7 lm/W | 5472 __ / _ 3<br>1-10V   | 580,00 € |
|                       |  | 5472 __ / _ 4<br>Triac   | 610,00 € |
|                       |  | 5472 __ / _ 5<br>Push    | 610,00 € |
|                       |  | 5472 __ / _ Z<br>Casambi | 700,00 € |

Materials

Diffuser: Polycarbonate. Shade: ABS.  
 Wall support: Aluminum.

Light Source and electronics

1 x LED STRIP 12,6 W 700 mA  
 Constant Current 700 mA  
 / \_ 1 110-240V 50/60Hz Bi-volt  
 / \_ 3 110-240V 50/60Hz Bi-volt  
 / \_ 5 110-240V 50/60Hz Bi-volt  
 / \_ 4 220-240V 50/60Hz  
 / \_ Z 220-240V 50/60Hz

Packaging

1 Box 0,51 x 0,51 x 0,26 m  
 Vol 0,0676 m<sup>3</sup>  
 Gross weight 4,75 Kg Net weight 2,25 Kg

Notes

A maximum of 8 modules can be connected to a single connection point. For bigger compositions, check connection system

LED IP20 CE EAC Bi-volt

5474

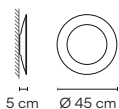

| Finishes                                       | LED temperature colour                             | Control                                 |                 |
|--|--|---|-----------------|
| ● <b>15/</b> _ _ Grey L2<br>(NCS S 2500-N)     | <b>/1</b> _ 2700 K<br>CRI >90 952,5 lm 113 lm/W    | <b>5474</b> _ _ / _ <b>1</b><br>DALI-2  | <b>550,00 €</b> |
| ● <b>21/</b> _ _ Black Grey<br>(NCS S 7000-N)  | <b>/3</b> _ 3500 K<br>CRI >90 1017,4 lm 121,1 lm/W | <b>5474</b> _ _ / _ <b>3</b><br>1-10V   | <b>520,00 €</b> |
| ● <b>28/</b> _ _ Brown M1<br>(NCS S 4020-Y60R) |  | <b>5474</b> _ _ / _ <b>4</b><br>Triac   | <b>550,00 €</b> |
|  |  | <b>5474</b> _ _ / _ <b>5</b><br>Push    | <b>550,00 €</b> |
|  |  | <b>5474</b> _ _ / _ <b>Z</b><br>Casambi | <b>640,00 €</b> |

| Finishes  | LED temperature colour                             | Control                                 |                 |
|---|--|---|-----------------|
| ● <b>71/</b> _ _ Grey Felt L1<br>& Grey Felt D1 | <b>/1</b> _ 2700 K<br>CRI >90 952,5 lm 113 lm/W    | <b>5474</b> _ _ / _ <b>1</b><br>DALI-2  | <b>605,00 €</b> |
| ● <b>76/</b> _ _ Grey Felt L1                   | <b>/3</b> _ 3500 K<br>CRI >90 1017,4 lm 121,1 lm/W | <b>5474</b> _ _ / _ <b>3</b><br>1-10V   | <b>575,00 €</b> |
|   |  | <b>5474</b> _ _ / _ <b>4</b><br>Triac   | <b>605,00 €</b> |
|   |  | <b>5474</b> _ _ / _ <b>5</b><br>Push    | <b>605,00 €</b> |
|   |  | <b>5474</b> _ _ / _ <b>Z</b><br>Casambi | <b>695,00 €</b> |

**Materials**

Diffuser: Polycarbonate. Shade: ABS.  
Wall support: Aluminum. Ring: Steel.

**Light Source and electronics**

1 x LED STRIP 8,4 W 700 mA  
Constant Current 700 mA  
/ \_ **1** 110~240V 50/60Hz Bi-volt  
/ \_ **3** 110~240V 50/60Hz Bi-volt  
/ \_ **5** 110~240V 50/60Hz Bi-volt  
/ \_ **4** 220~240V 50/60Hz  
/ \_ **Z** 220~240V 50/60Hz

**Packaging**

1 Box 0,51 x 0,51 x 0,26 m  
Vol 0,0676 m<sup>3</sup>  
Gross weight 4,75 Kg Net weight 2,25 Kg

**Notes**

A maximum of 8 modules can be connected to a single connection point. For bigger compositions, check connection system

5476

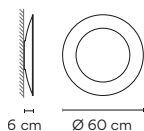

| Finishes                               | LED temperature colour                     | Control                  |          |
|--|--|--------------------------|----------|
| ● 15/ __ Grey L2<br>(NCS S 2500-N)     | /1_ 2700 K<br>CRI >90 1435,9 lm 114 lm/W   | 5476 __ / _ 1<br>DALI-2  | 680,00 € |
| ● 21/ __ Black Grey<br>(NCS S 7000-N)  | /3_ 3500 K<br>CRI >90 1533,8 lm 121,7 lm/W | 5476 __ / _ 3<br>1-10V   | 645,00 € |
| ● 28/ __ Brown M1<br>(NCS S 4020-Y60R) |  | 5476 __ / _ 4<br>Triac   | 680,00 € |
|  |  | 5476 __ / _ 5<br>Push    | 680,00 € |
|  |  | 5476 __ / _ Z<br>Casambi | 765,00 € |

| Finishes                                | LED temperature colour                     | Control                  |          |
|---|--|--------------------------|----------|
| ● 71/ __ Grey Felt L1<br>& Grey Felt D1 | /1_ 2700 K<br>CRI >90 1435,9 lm 114 lm/W   | 5476 __ / _ 1<br>DALI-2  | 735,00 € |
| ● 76/ __ Grey Felt L1                   | /3_ 3500 K<br>CRI >90 1533,8 lm 121,7 lm/W | 5476 __ / _ 3<br>1-10V   | 700,00 € |
|   |  | 5476 __ / _ 4<br>Triac   | 735,00 € |
|   |  | 5476 __ / _ 5<br>Push    | 735,00 € |
|   |  | 5476 __ / _ Z<br>Casambi | 820,00 € |

Materials

Diffuser: Polycarbonate. Shade: ABS.  
 Wall support: Aluminum. Ring: Steel.

Light Source and electronics

1 x LED STRIP 12,6 W 700 mA  
 Constant Current 700 mA  
 / \_ 1 110-240V 50/60Hz Bi-volt  
 / \_ 3 110-240V 50/60Hz Bi-volt  
 / \_ 5 110-240V 50/60Hz Bi-volt  
 / \_ 4 220-240V 50/60Hz  
 / \_ Z 220-240V 50/60Hz

Packaging

1 Box 0,66 x 0,66 x 0,235 m  
 Vol 0,1024 m<sup>3</sup>  
 Gross weight 6,3 Kg Net weight 2,9 Kg

Notes

A maximum of 8 modules can be connected to a single connection point. For bigger compositions, check connection system

LED IP20 CE EAC Bi-volt

5480

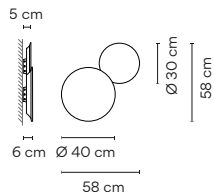

| Finishes                                       | LED temperature colour                     | Control                          |                 |
|--|--|----------------------------------|-----------------|
| ● <b>15/</b> _ _ Grey L2<br>(NCS S 2500-N)     | /1_ 2700 K<br>CRI >90 2388,4 lm 114 lm/W   | <b>5480</b> _ _ / _ 1<br>DALI-2  | <b>870,00 €</b> |
| ● <b>28/</b> _ _ Brown M1<br>(NCS S 4020-Y60R) | /3_ 3500 K<br>CRI >90 2551,3 lm 121,5 lm/W | <b>5480</b> _ _ / _ 3<br>1-10V   | <b>825,00 €</b> |
| ● <b>72/</b> _ _ Grey D1<br>& Grey L2          |  | <b>5480</b> _ _ / _ 4<br>Triac   | <b>870,00 €</b> |
|  |  | <b>5480</b> _ _ / _ 5<br>Push    | <b>870,00 €</b> |
|  |  | <b>5480</b> _ _ / _ Z<br>Casambi | <b>945,00 €</b> |

| Finishes  | LED temperature colour                     | Control                          |                   |
|---|--|----------------------------------|-------------------|
| ● <b>71/</b> _ _ Grey Felt L1<br>& Grey Felt D1 | /1_ 2700 K<br>CRI >90 2388,4 lm 114 lm/W   | <b>5480</b> _ _ / _ 1<br>DALI-2  | <b>980,00 €</b>   |
| ● <b>76/</b> _ _ Grey Felt L1                   | /3_ 3500 K<br>CRI >90 2551,3 lm 121,5 lm/W | <b>5480</b> _ _ / _ 3<br>1-10V   | <b>935,00 €</b>   |
|   |  | <b>5480</b> _ _ / _ 4<br>Triac   | <b>980,00 €</b>   |
|   |  | <b>5480</b> _ _ / _ 5<br>Push    | <b>980,00 €</b>   |
|   |  | <b>5480</b> _ _ / _ Z<br>Casambi | <b>1.055,00 €</b> |

Materials

Diffuser: Polycarbonate. Shade: ABS.  
Wall support: Aluminum.

Light Source and electronics

1 x LED STRIP 8,4 W 700 mA  
1 x LED STRIP 12,6 W 700 mA  
Constant Current 700 mA  
/ \_ 1 110~240V 50/60Hz Bi-volt  
/ \_ 3 110~240V 50/60Hz Bi-volt  
/ \_ 5 110~240V 50/60Hz Bi-volt  
/ \_ 4 220~240V 50/60Hz  
/ \_ Z 220~240V 50/60Hz

Packaging

1 Box 0,46 x 0,46 x 0,4 m  
Vol 0,0846 m<sup>3</sup>  
Gross weight 6,1 Kg Net weight 3,4 Kg

Notes

A maximum of 8 modules can be connected to a single connection point. For bigger compositions, check connection system



5481

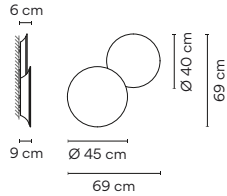

| Finishes                               | LED temperature colour                     | Control                  |            |
|--|--|--------------------------|------------|
| ● 15/ __ Grey L2<br>(NCS S 2500-N)     | /1_ 2700 K<br>CRI >90 2871,9 lm 114 lm/W   | 5481 __ / _ 1<br>DALI-2  | 995,00 €   |
| ● 28/ __ Brown M1<br>(NCS S 4020-Y60R) | /3_ 3500 K<br>CRI >90 3067,7 lm 121,7 lm/W | 5481 __ / _ 3<br>1-10V   | 945,00 €   |
| ● 72/ __ Grey D1<br>& Grey L2          |  | 5481 __ / _ 4<br>Triac   | 995,00 €   |
|  |  | 5481 __ / _ 5<br>Push    | 995,00 €   |
|  |  | 5481 __ / _ Z<br>Casambi | 1.065,00 € |

| Finishes                                | LED temperature colour                     | Control                  |            |
|---|--|--------------------------|------------|
| ● 71/ __ Grey Felt L1<br>& Grey Felt D1 | /1_ 2700 K<br>CRI >90 2871,9 lm 114 lm/W   | 5481 __ / _ 1<br>DALI-2  | 1.105,00 € |
| ● 76/ __ Grey Felt L1                   | /3_ 3500 K<br>CRI >90 3067,7 lm 121,7 lm/W | 5481 __ / _ 3<br>1-10V   | 1.055,00 € |
|   |  | 5481 __ / _ 4<br>Triac   | 1.105,00 € |
|   |  | 5481 __ / _ 5<br>Push    | 1.105,00 € |
|   |  | 5481 __ / _ Z<br>Casambi | 1.175,00 € |

Materials

Diffuser: Polycarbonate. Shade: ABS.  
 Wall support: Aluminum.

Light Source and electronics

1 x LED STRIP 8,4 W 700 mA  
 1 x LED STRIP 12,6 W 700 mA  
 Constant Current 700 mA  
 / \_ 1 110~240V 50/60Hz Bi-volt  
 / \_ 3 110~240V 50/60Hz Bi-volt  
 / \_ 5 110~240V 50/60Hz Bi-volt  
 / \_ 4 220~240V 50/60Hz  
 / \_ Z 220~240V 50/60Hz

Packaging

1 Box 0,46 x 0,46 x 0,4 m  
 Vol 0,0846 m<sup>3</sup>  
 Gross weight 6,1 Kg Net weight 3,4 Kg



5485

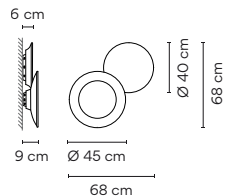

| Finishes                             | LED temperature colour                           | Control                                 |                   |
|--------------------------------------|--|---|-------------------|
| ● <b>72/</b> _ _ Grey D1 & Grey L2   | <b>/1</b> _ 2700 K  CRI >90 2388,4 lm 114 lm/W   | <b>5485</b> _ _ / _ <b>1</b><br>DALI-2  | <b>1.195,00 €</b> |
| ● <b>73/</b> _ _ Brown M1 & Grey D1) | <b>/3</b> _ 3500 K  CRI >90 2551,3 lm 121,5 lm/W | <b>5485</b> _ _ / _ <b>3</b><br>1-10V   | <b>1.135,00 €</b> |
|                                      |  | <b>5485</b> _ _ / _ <b>4</b><br>Triac   | <b>1.195,00 €</b> |
|                                      |  | <b>5485</b> _ _ / _ <b>5</b><br>Push    | <b>1.195,00 €</b> |
|                                      |  | <b>5485</b> _ _ / _ <b>Z</b><br>Casambi | <b>1.255,00 €</b> |

| Finishes                                     | LED temperature colour                           | Control                                 |                   |
|--|--|---|-------------------|
| ● <b>71/</b> _ _ Grey Felt L1 & Grey Felt D1 | <b>/1</b> _ 2700 K  CRI >90 2388,4 lm 114 lm/W   | <b>5485</b> _ _ / _ <b>1</b><br>DALI-2  | <b>1.305,00 €</b> |
|  | <b>/3</b> _ 3500 K  CRI >90 2551,3 lm 121,5 lm/W | <b>5485</b> _ _ / _ <b>3</b><br>1-10V   | <b>1.245,00 €</b> |
|  |  | <b>5485</b> _ _ / _ <b>4</b><br>Triac   | <b>1.305,00 €</b> |
|  |  | <b>5485</b> _ _ / _ <b>5</b><br>Push    | <b>1.305,00 €</b> |
|  |  | <b>5485</b> _ _ / _ <b>Z</b><br>Casambi | <b>1.365,00 €</b> |

Materials

Diffuser: Polycarbonate. Shade: ABS.  
Wall support: Aluminum. Ring: Steel.

Light Source and electronics

1 x LED STRIP 8,4 W 700 mA  
1 x LED STRIP 12,6 W 700 mA  
Constant Current 700 mA  
**/ \_ 1** 110~240V 50/60Hz Bi-volt  
**/ \_ 3** 110~240V 50/60Hz Bi-volt  
**/ \_ 5** 110~240V 50/60Hz Bi-volt  
**/ \_ 4** 220~240V 50/60Hz  
**/ \_ Z** 220~240V 50/60Hz

Packaging

1 Box 0,51 x 0,51 x 0,43 m  
Vol 0,1118 m<sup>3</sup>  
Gross weight 8,42 Kg Net weight 4,22 Kg



5486

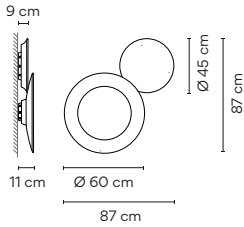

| Finishes                     | LED temperature colour                   | Control               |            |
|------------------------------|--|-----------------------|------------|
| ● 72/ __ Grey D1 & Grey L2   | /1_ 2700 K  CRI >90 2871,9 lm 114 lm/W   | 5486 __ / _ 1 DALI-2  | 1.375,00 € |
| ● 73/ __ Brown M1 & Grey D1) | /3_ 3500 K  CRI >90 3067,7 lm 121,7 lm/W | 5486 __ / _ 3 1-10V   | 1.305,00 € |
|                              |  | 5486 __ / _ 4 Triac   | 1.375,00 € |
|                              |  | 5486 __ / _ 5 Push    | 1.375,00 € |
|                              |  | 5486 __ / _ Z Casambi | 1.425,00 € |

| Finishes                             | LED temperature colour                   | Control               |            |
|--------------------------------------|--|-----------------------|------------|
| ● 71/ __ Grey Felt L1 & Grey Felt D1 | /1_ 2700 K  CRI >90 2871,9 lm 114 lm/W   | 5486 __ / _ 1 DALI-2  | 1.485,00 € |
|                                      | /3_ 3500 K  CRI >90 3067,7 lm 121,7 lm/W | 5486 __ / _ 3 1-10V   | 1.415,00 € |
|                                      |  | 5486 __ / _ 4 Triac   | 1.485,00 € |
|                                      |  | 5486 __ / _ 5 Push    | 1.485,00 € |
|                                      |  | 5486 __ / _ Z Casambi | 1.535,00 € |

Materials

Diffuser: Polycarbonate. Shade: ABS.  
 Wall support: Aluminum. Ring: Steel.

Light Source and electronics

2 x LED STRIP 12,6 W 700 mA  
 Constant Current 700 mA

- / \_ 1 110-240V 50/60Hz Bi-volt
- / \_ 3 110-240V 50/60Hz Bi-volt
- / \_ 5 110-240V 50/60Hz Bi-volt
- / \_ 4 220-240V 50/60Hz
- / \_ Z 220-240V 50/60Hz

Packaging

1 Box 0,66 x 0,66 x 0,5 m  
 Vol 0,2178 m<sup>3</sup>  
 Gross weight 11,35 Kg Net weight 5,45 Kg



5487

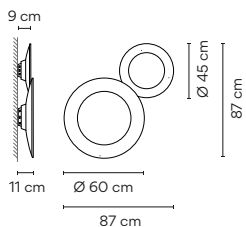

| Finishes                                   | LED temperature colour                   | Control                       |            |
|--|--|-------------------------------|------------|
| ● <b>21/</b> _ _ Black Grey (NCS S 7000-N) | /1_ 2700 K  CRI >90 2388,4 lm 114 lm/W   | <b>5487</b> _ _ / _ 1 DALI-2  | 1.245,00 € |
| ● <b>73/</b> _ _ Brown M1 & Grey D1        | /3_ 3500 K  CRI >90 2551,3 lm 121,5 lm/W | <b>5487</b> _ _ / _ 3 1-10V   | 1.185,00 € |
|  |  | <b>5487</b> _ _ / _ 4 Triac   | 1.245,00 € |
|  |  | <b>5487</b> _ _ / _ 5 Push    | 1.245,00 € |
|  |  | <b>5487</b> _ _ / _ Z Casambi | 1.305,00 € |

| Finishes                                    | LED temperature colour                   | Control                       |            |
|---|--|-------------------------------|------------|
| ● <b>71/</b> _ _ Grey Felt L1 & Grey Felt D | /1_ 2700 K  CRI >90 2388,4 lm 114 lm/W   | <b>5487</b> _ _ / _ 1 DALI-2  | 1.355,00 € |
|   | /3_ 3500 K  CRI >90 2551,3 lm 121,5 lm/W | <b>5487</b> _ _ / _ 3 1-10V   | 1.295,00 € |
|   |  | <b>5487</b> _ _ / _ 4 Triac   | 1.355,00 € |
|   |  | <b>5487</b> _ _ / _ 5 Push    | 1.355,00 € |
|   |  | <b>5487</b> _ _ / _ Z Casambi | 1.415,00 € |

Materials

Diffuser: Polycarbonate. Shade: ABS.  
Wall support: Aluminum. Ring: Steel.

Light Source and electronics

1 x LED STRIP 8,4 W 700 mA  
1 x LED STRIP 12,6 W 700 mA  
Constant Current 700 mA  
/ \_ 1 110-240V 50/60Hz Bi-volt  
/ \_ 3 110-240V 50/60Hz Bi-volt  
/ \_ 5 110-240V 50/60Hz Bi-volt  
/ \_ 4 220-240V 50/60Hz  
/ \_ Z 220-240V 50/60Hz

Packaging

1 Box 0,66 x 0,66 x 0,5 m  
Vol 0,2178 m<sup>3</sup>  
Gross weight 11,52 Kg Net weight 5,62 Kg



**5491**

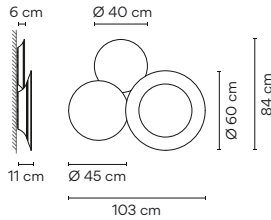

| Finishes                           | LED temperature colour                   | Control                      |                   |
|------------------------------------|--|------------------------------|-------------------|
| ● <b>72/</b> __ Grey D1 & Grey L2  | /1_ 2700 K  CRI >90 4307,8 lm 114 lm/W   | <b>5491</b> __ / _ 1 DALI-2  | <b>1.920,00 €</b> |
| ● <b>73/</b> __ Brown M1 & Grey D1 | /3_ 3500 K  CRI >90 4601,5 lm 121,7 lm/W | <b>5491</b> __ / _ 3 1-10V   | <b>1.825,00 €</b> |
|                                    |  | <b>5491</b> __ / _ 4 Triac   | <b>1.920,00 €</b> |
|                                    |  | <b>5491</b> __ / _ 5 Push    | <b>1.920,00 €</b> |
|                                    |  | <b>5491</b> __ / _ Z Casambi | <b>1.945,00 €</b> |

| Finishes                                    | LED temperature colour                   | Control                      |                   |
|---|--|------------------------------|-------------------|
| ● <b>71/</b> __ Grey Felt L1 & Grey Felt D1 | /1_ 2700 K  CRI >90 4307,8 lm 114 lm/W   | <b>5491</b> __ / _ 1 DALI-2  | <b>2.085,00 €</b> |
|   | /3_ 3500 K  CRI >90 4601,5 lm 121,7 lm/W | <b>5491</b> __ / _ 3 1-10V   | <b>1.990,00 €</b> |
|   |  | <b>5491</b> __ / _ 4 Triac   | <b>2.085,00 €</b> |
|   |  | <b>5491</b> __ / _ 5 Push    | <b>2.085,00 €</b> |
|   |  | <b>5491</b> __ / _ Z Casambi | <b>2.110,00 €</b> |

**Materials**

Diffuser: Polycarbonate. Shade: ABS.  
 Wall support: Aluminum. Ring: Steel.

**Light Source and electronics**

3 x LED STRIP 12,6 W 700 mA  
 Constant Current 700 mA

- / \_ 1 110~240V 50/60Hz Bi-volt
- / \_ 3 110~240V 50/60Hz Bi-volt
- / \_ 5 110~240V 50/60Hz Bi-volt
- / \_ 4 220~240V 50/60Hz
- / \_ Z 220~240V 50/60Hz

**Packaging**

1 Box 0,66 x 0,66 x 0,67 m  
 Vol 0,2919 m<sup>3</sup>  
 Gross weight 14,85 Kg Net weight 7,35 Kg



# Mayfair Mini

Design by Diego Fortunato

Mayfair is a modern reimagining of the traditional 19th-century lights, distinguished by its timeless design and sleek silhouette.

## Table



Portable

5495



5496



5497

5495

### Finishes

- 23 Warm White (NCS S 0502-Y50R)
- 25 Beige D1 (NCS S 4005-Y50R)
- 37 Terra Red (NCS S 4040-Y70R)
- 47 Green L1 (NCS S 6005-G80Y)

### LED temperature colour

/1\_ 2700 K  CRI >90 223 lm 86 lm/W

### Control

5495 \_\_ / \_\_ 6  
Touch sensor

245,00 €

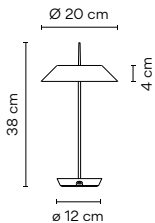

### Materials

Base and shade: Polycarbonate. Diffuser: Translucent polycarbonate. Stem: Stainless steel.

### Light Source and electronics

1 x LED PLATE 5V 2,5 W  
Constant Voltage 5V  
100~240V 50/60Hz

### Packaging

1 Box 0,25 x 0,26 x 0,50 m  
Vol 0,033 m<sup>3</sup>  
Gross weight 1,62 Kg Net weight 0,73 Kg

### Notes

Rechargeable battery autonomy:  
6h at 100% Intensity.  
12h at 50% Intensity.  
18h at 25% Intensity.

USB-C cable: length 1,20 m  
(from the base to the USB charger).

5496

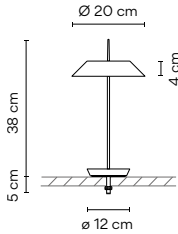

Finishes

- 23 Warm White (NCS S 0502-Y50R)
- 25 Beige D1 (NCS S 4005-Y50R)
- 37 Terra Red (NCS S 4040-Y70R)
- 47 Green L1 (NCS S 6005-G80Y)

LED temperature colour

/1\_ 2700 K CRI >90 223 lm 86 lm/W

Control

5496 \_ \_ / \_ 6  
 Touch sensor

235,00 €

Materials

Base and shade: Polycarbonate. Diffuser: Translucent polycarbonate. Stem: Stainless steel.

Light Source and electronics

1 x LED PLATE 5V 2,5 W  
 Constant Voltage 5V  
 100~240V 50/60Hz

Packaging

1 Box 0,25 x 0,26 x 0,50 m  
 Vol 0,033 m<sup>3</sup>  
 Gross weight 1,84 Kg Net weight 0,94 Kg

Notes

Cable length: 1 m  
 (from the base to the USB charger)



5497

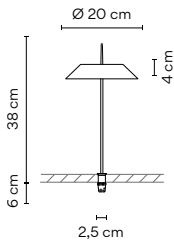

Finishes

- 23 Warm White (NCS S 0502-Y50R)
- 25 Beige D1 (NCS S 4005-Y50R)
- 37 Terra Red (NCS S 4040-Y70R)
- 47 Green L1 (NCS S 6005-G80Y)

LED temperature colour

/1\_ 2700 K CRI >90 223 lm 86 lm/W

Control

5497 \_ \_ / \_ 0  
 On/ Off

195,00 €

5497 \_ \_ / \_ 1  
 DALI

205,00 €

5497 \_ \_ / \_ 3  
 1-10V

205,00 €

Materials

Base and shade: Polycarbonate. Diffuser: Translucent polycarbonate. Stem: Stainless steel.

Light Source and electronics

1 x LED PLATE 5V 2,5 W  
 Constant Voltage 5V  
 100~240V 50/60Hz

Packaging

1 Box 0,25 x 0,26 x 0,50 m  
 Vol 0,033 m<sup>3</sup>  
 Gross weight 1,45 Kg Net weight 0,54 Kg

Notes

Cable length: 1 m. (the cable connects directly to the remote driver)



# Mayfair

Design by Diego Fortunato

Mayfair is a modern reimagining of the traditional 19<sup>th</sup>-century lights, distinguished by its timeless design and sleek silhouette.

## Table Floor



|             |  |  |  |   |
|-------------|--|--|--|---|
| <b>5500</b> | <b>Finishes</b><br><ul style="list-style-type: none"> <li>● <b>07/</b> __ Graphite and green (RAL 7016. RAL 6026)</li> <li>● <b>08/</b> __ Graphite and orange (RAL 7016. RAL 2009)</li> </ul> | <b>LED temperature colour</b><br><b>/1</b> 2700 K<br>CRI >90 2027,0 lm 135 lm/W  | <b>Control</b><br><b>5500</b> _ / _ <b>6</b><br>Optical sensor   | <b>595,00 €</b>   |
|             | <b>Materials</b><br>Diffuser: Polycarbonate. Shade: Methacrylate.<br>Tube: Steel. Base: Zamak.   | <b>Light Source and electronics</b><br>1 x LED STRIP 24V 2,4 W<br>1 x LED STRIP 24V 12,6 W<br>Constant Voltage 24V<br>100~240V 50/60Hz | <b>Packaging</b><br>1 Box 0,22 x 0,35 x 0,61 m<br>Vol 0,0470 m <sup>3</sup><br>Gross weight 3,6 Kg Net weight 3,4 Kg | <b>Notes</b><br>Touch dimmer on base. Electric cable 2 m.<br>Ask if you require Push without memory (hotel room type) |

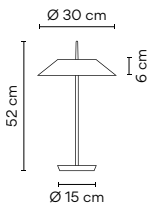



5505

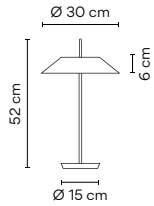

| Finishes                     | LED temperature colour                 | Control                      |          |
|------------------------------|--|------------------------------|----------|
| ● 18/ __ Graphite (RAL 7016) | /1_ 2700 K  CRI >90 2027,0 lm 135 lm/W | 5505 __ / _ 6 Optical sensor | 595,00 € |
| ● 93/ __ White (RAL 9016)    |  |                              |          |

Finish customization  
 (Available options:  
 Vibia colour palette)

| Finishes        | LED temperature colour                 | Control                      |          |
|-----------------|--|------------------------------|----------|
| ● 20/ __ Gold   | /1_ 2700 K  CRI >90 2027,0 lm 135 lm/W | 5505 __ / _ 6 Optical sensor | 795,00 € |
| ● 67/ __ Copper |  |                              |          |

Materials

Diffuser: Polycarbonate. Shade and tube: Steel.  
 Base: Zamak.

Light Source and electronics

1 x LED STRIP 24V 2,4 W  
 1 x LED STRIP 24V 12,6 W  
 Constant Voltage 24V  
 100~240V 50/60Hz

Packaging

1 Box 0,22 x 0,35 x 0,61 m  
 Vol 0,0470 m<sup>3</sup>  
 Gross weight 3,6 Kg Net weight 3,4 Kg

Notes

Touch dimmer on base. Electric cable 2 m







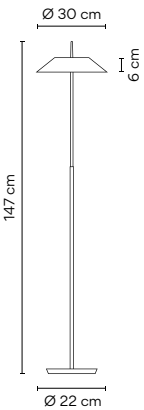

LED  IP20

Dimmer  Bi-volt











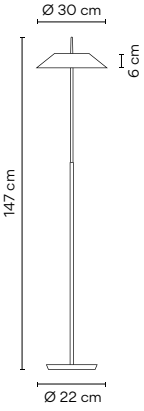

**5510**



|   |  |   |                        |
|---|--|---|------------------------|
| <p><b>Finishes</b></p> <ul style="list-style-type: none"> <li>● <b>07/</b> __ Graphite and green (RAL 7016, RAL 6026)</li> <li>● <b>08/</b> __ Graphite and orange (RAL 7016, RAL 2009)</li> </ul>  | <p><b>LED temperature colour</b></p> <p>/1_ 2700 K  CRI &gt;90 2027,0 lm 135 lm/W</p> | <p><b>Control</b></p> <p><b>5510</b> __ / __ <b>6</b><br/>Optical sensor</p>  | <p><b>935,00 €</b></p> |
| <p><b>Materials</b></p> <p>Diffuser: Polycarbonate. Shade: Methacrylate. Tube: Steel. Base: Zamak.</p>  |  | <p><b>Packaging</b></p> <p>1 Box 1,50 x 0,32 x 0,34 m<br/>Vol 0,1630 m<sup>3</sup><br/>Gross weight 12,8 Kg Net weight 6,2 Kg</p> |                        |
| <p><b>Light Source and electronics</b></p> <p>1 x LED STRIP 24V 2,4 W<br/>1 x LED STRIP 24V 12,6 W<br/>Constant Voltage 24V<br/>100~240V 50/60Hz</p>  |  | <p><b>Notes</b></p> <p>Touch dimmer on shade. Electric cable 2 m</p>  |                        |
| <p>      </p> <p>   </p> |  |   |                        |

**5515**



|   |  |  |                          |
|---|--|--|--------------------------|
| <p><b>Finishes</b></p> <ul style="list-style-type: none"> <li>● <b>18/</b> __ Graphite (RAL 7016)</li> <li>● <b>93/</b> __ White (RAL 9016)</li> </ul> <p><b>Finish customization</b><br/>(Available options: Vibia colour palette)</p>   | <p><b>LED temperature colour</b></p> <p>/1_ 2700 K  CRI &gt;90 2027,0 lm 135 lm/W</p> | <p><b>Control</b></p> <p><b>5515</b> __ / __ <b>6</b><br/>Optical sensor</p>   | <p><b>935,00 €</b></p>   |
| <p><b>Finishes</b></p> <ul style="list-style-type: none"> <li>● <b>20/</b> __ Gold</li> <li>● <b>67/</b> __ Copper</li> </ul>   |  | <p><b>LED temperature colour</b></p> <p>/1_ 2700 K  CRI &gt;90 2027,0 lm 135 lm/W</p> | <p><b>1.135,00 €</b></p> |
| <p><b>Materials</b></p> <p>Diffuser: Polycarbonate. Shade and tube: Steel. Base: Zamak.</p>   |  | <p><b>Packaging</b></p> <p>1 Box 1,50 x 0,32 x 0,34 m<br/>Vol 0,1630 m<sup>3</sup><br/>Gross weight 12,8 Kg Net weight 6,2 Kg</p>  |                          |
| <p><b>Light Source and electronics</b></p> <p>1 x LED STRIP 24V 2,4 W<br/>1 x LED STRIP 24V 12,6 W<br/>Constant Voltage 24V<br/>100~240V 50/60Hz</p>  |  | <p><b>Notes</b></p> <p>Touch dimmer on shade. Electric cable 2 m</p>   |                          |
| <p>      </p> <p>   </p> |  |  |                          |



## Pendants



Ø 30 cm

5520

Ø 30 cm

5525

### 5520

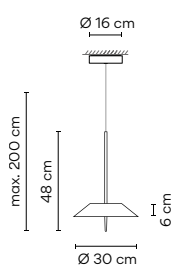

- Finishes**
- **07/** \_ \_ Graphite and green (RAL 7016. RAL 6026)
  - **08/** \_ \_ Graphite and orange (RAL 7016. RAL 2009)

**LED temperature colour**  
/1\_ 2700 K   
CRI >90 2027,0 lm 135 lm/W

| Control                       | Price    |
|-------------------------------|----------|
| 5520 _ _ / _ 1<br>DALI        | 725,00 € |
| 5520 _ _ / _ B<br>1-10V, Push | 690,00 € |
| 5520 _ _ / _ Z<br>Casambi     | 810,00 € |

**Materials**  
Diffuser: Polycarbonate. Shade: Methacrylate.  
Tube and canopy: Steel.

**Light Source and electronics**  
1 x LED STRIP 24V 2,4 W  
1 x LED STRIP 24V 12,6 W  
Constant Voltage 24V  
220~240V 50/60Hz

**Packaging**  
1 Box 0,50 x 0,31 x 0,31 m  
Vol 0,0500 m<sup>3</sup>  
Gross weight 2,8 Kg Net weight 1,8 Kg

**Notes**  
Extra cable length. 16,00 €/m

LED IP20 EAC

**Electrical connection**  
Surface  
\_18 Free Wire  
\_23 Built-in  
\_31 Remote  
Micro  
for plaster ceilings  
\_32 Remote  
XXS  
for all types of drop ceilings



5525

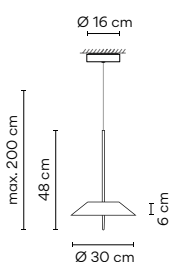

| Finishes   | LED temperature colour                  | Control                   |            |
|--|---|---------------------------|------------|
| ● 18/ __ Graphite (RAL 7016)                                   | /1 _ 2700 K  CRI >90 2027,0 lm 135 lm/W | 5525 __ / _ 1 DALI        | 725,00 €   |
| ● 93/ __ White (RAL 9016)                                      |   | 5525 __ / _ B 1-10V, Push | 690,00 €   |
| Finish customization (Available options: Vibia colour palette) |   | 5525 __ / _ Z Casambi     | 810,00 €   |
| Finishes   | LED temperature colour                  | Control                   |            |
| ● 20/ __ Gold  | /1 _ 2700 K  CRI >90 2027,0 lm 135 lm/W | 5525 __ / _ 1 DALI        | 925,00 €   |
| ● 67/ __ Copper  |   | 5525 __ / _ B 1-10V, Push | 890,00 €   |
|  |   | 5525 __ / _ Z Casambi     | 1.010,00 € |

Electrical connection

- Surface
- \_18 Free Wire
- \_23 Built-in
- \_31 Remote Micro for plaster ceilings
- \_32 Remote XXS for all types of drop ceilings

**Materials**  
Diffuser: Polycarbonate.  
Shade, tube and canopy: Steel.

**Light Source and electronics**  
1 x LED STRIP 24V 2,4 W  
1 x LED STRIP 24V 12,6 W  
Constant Voltage 24V  
220-240V 50/60Hz

**Packaging**  
1 Box 0,50 x 0,31 x 0,31 m  
Vol 0,0500 m<sup>3</sup>  
Gross weight 2,9 Kg Net weight 1,9 Kg

**Notes**  
Extra cable length. 16,00 €/m

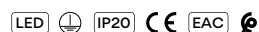

# Composing pendants

Next sketches are composed by one or more compositions

---

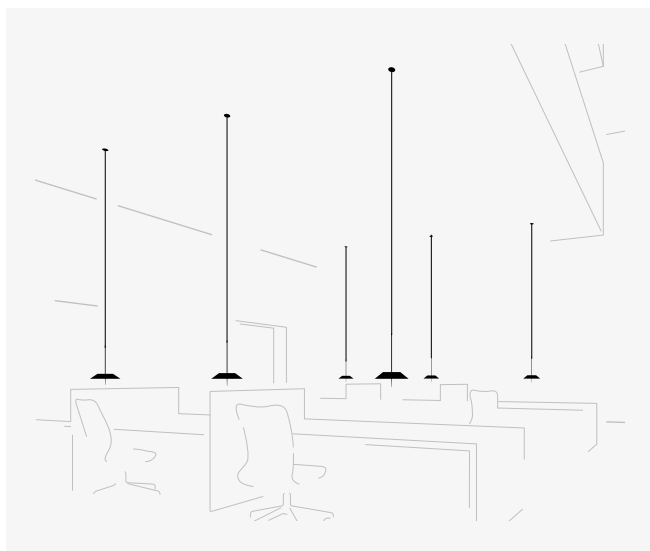

6 x 5520.

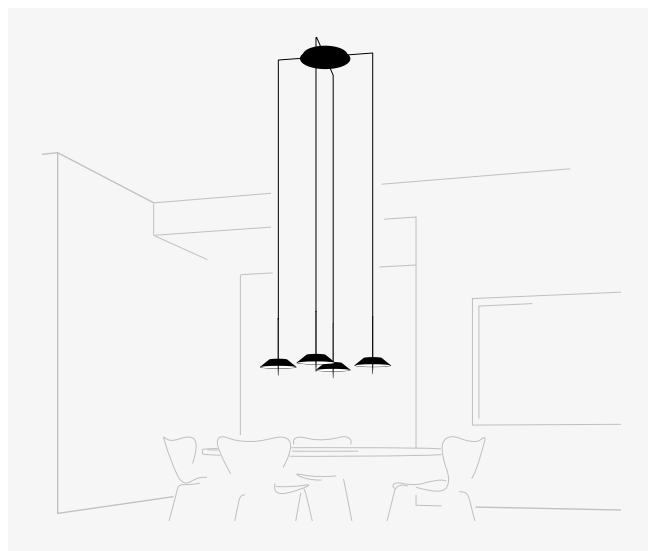

4 x 5525.



4 x 5525.

Each project is unique.  
Visit [vibia.com](http://vibia.com) and  
choose among multiple  
compositions designed  
and adapted to your  
project needs.

Personalise your own  
Mayfair composition quick  
and easy at [vibia.com](http://vibia.com)

# Electrical connection options for models 5520 / 5525

Choose your preferred installation option according to your needs. For each composition, the optimal minimum number of drivers will be delivered.

## Drop ceiling

The innovative remote and built-in fittings accentuate the silkiness and lightness of compositions on suspended ceilings, its great visual grandeur taking center stage.

For Ref. 5520 / 5525

### Remote

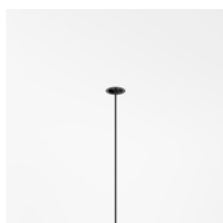

**Micro** ø 3 cm  
height 7 cm  
for plaster ceilings.  
Black finish.

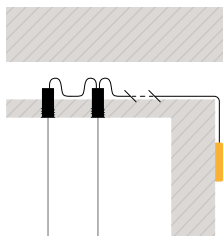

### Built-in



ø 8 cm  
height 6 cm  
match with  
fixture finish.

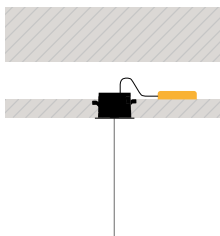

---

## Regular ceiling

When architecture does not allow for performance, surface and free wire showcase possibilities for any need or desire with no limits, ideal for both individual or cluster arrangements.

For Ref. 5520 / 5525

### Surface



ø 16 cm

match with  
fixture finish.

### Free Wire



1 wire



2 - 6 wires



7 - 9 wires

ø 20 cm

ø 36 cm

ø 40 cm

you can choose the finish of the canopy  
among black, white or any colour  
matching one of the pendants.

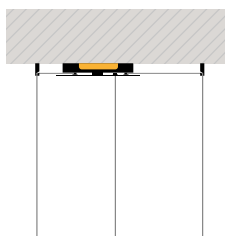
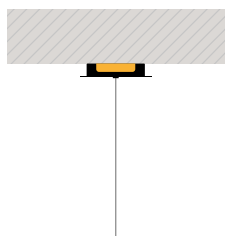

# Africa

Design by Francisco Gomez Paz

An object of desire, Africa is a unique gift that combines richness of form and materiality with high performance lighting capabilities. A holistic exploration of beauty, functionality and the essence of humanity.

## Table

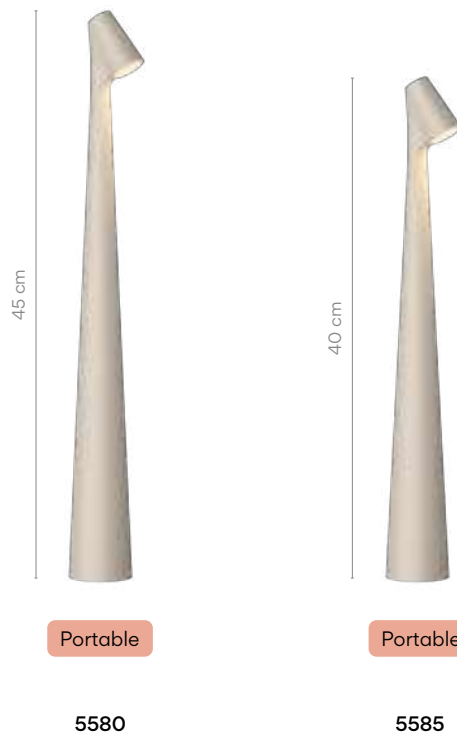

|  |   |   |  |                        |
|--|---|---|--|------------------------|
| <p><b>5580</b></p> <p>Ø 5 cm</p>   | <p><b>Finishes</b></p> <ul style="list-style-type: none"> <li>● <b>24/</b> __ Beige M1<br/>(NCS S 2005-Y50R)</li> <li>● <b>25/</b> __ Beige D1<br/>(NCS S 4005-Y50R)</li> <li>● <b>29/</b> __ Brown D1<br/>(NCS S 8005-Y50R)</li> <li>● <b>38/</b> __ Terra Dark<br/>(NCS S 5040-Y70R)</li> </ul> | <p><b>LED temperature colour</b></p> <p>/1 _ 2700 K  <br/>CRI &gt;90 520 lm 117 lm/W</p>  | <p><b>Control</b></p> <p><b>5580</b> __ / _ 5<br/>Push</p> | <p><b>295,00 €</b></p> |
| <p><b>Materials</b></p> <p>Body: Aluminium.<br/>Diffuser: Polycarbonate</p>  |   | <p><b>Packaging</b></p> <p>1 Box 0,08 m x 0,53 m<br/>Vol 0,0026 m<sup>3</sup><br/>Gross weight 1,23 Kg Net weight 0,9 Kg</p>  |  |                        |
| <p><b>Light Source and electronics</b></p> <p>1 x LED 4,5W 500 mA<br/>Output: DC 5.0 V 2.0 A 10.0W<br/>Input: 100~240V 50/60Hz</p> |   | <p><b>Notes</b></p> <p>Battery capacity 10.000mAh.<br/>Battery voltage 3,7V.<br/>Rechargeable battery autonomy:<br/>6,5h at 100% Intensity.<br/>10h at 66% Intensity.<br/>20h at 33% Intensity.</p> |  |                        |
| <p> </p>   |   |   |  |                        |





5585

Finishes

- 24/ \_ \_ Beige M1  
(NCS S 2005-Y50R)
- 25/ \_ \_ Beige D1  
(NCS S 4005-Y50R)
- 29/ \_ \_ Brown D1  
(NCS S 8005-Y50R)
- 38/ \_ \_ Terra Dark  
(NCS S 5040-Y70R)

LED temperature colour

/1\_ 2700 K   
 CRI >90 520 lm 117 lm/W

Control

5585 \_ \_ / \_ 5  
 Push

295,00 €

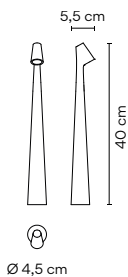

Materials

Body: Aluminium.  
 Diffuser: Polycarbonate

Light Source and electronics

1 x LED 4,5W 500 mA  
 Output: DC 5.0 V 2.0 A 10.0W  
 Input: 100~240V 50/60Hz

Packaging

1 Box 0,08 m x 0,53 m  
 Vol 0,0026 m<sup>3</sup>  
 Gross weight 1,23 Kg Net weight 0,9 Kg

Notes

Battery capacity 10.000mAh.  
 Battery voltage 3,7V.  
 Rechargeable battery autonomy:  
 6,5h at 100% Intensity.  
 10h at 66% Intensity.  
 20h at 33% Intensity.

# North

Design by Arik Levy

North, south, east and west are our points of references in space; we set-out, build and travel according to these coordinates.

---

## Floor



max. 250 cm x max. 210 cm x max. 355 cm

**5600**



max. 270 cm x max. 270 cm x max. 355 cm

**5605**

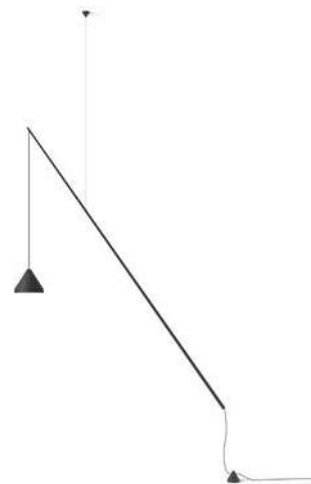

max. 210 cm x max. 310 cm x max. 130 cm

**5666**



max. 447 cm x max. 325 cm x max. 425 cm

**5620**



max. 270 cm x max. 270 cm x max. 355 cm

**5625**

5600

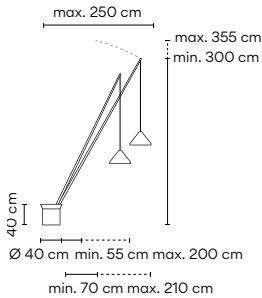

- Finishes**
- 10/ \_\_ White (NCS S 0300-N)
  - 11/ \_\_ Black (NCS S 8500 N)
  - 24/ \_\_ Beige M1 (NCS S 2005-Y50R)
  - 42 / \_\_ Blue M1 (NCS S 5010-B10G)

**LED temperature colour**  
 /1\_ 2700 K   
 CRI >90 2538,0 lm 141 lm/W

**Control**  
 5600 \_\_ / \_ 5  
 Push 3.355,00 €

**Materials**  
 Rods: Carbon fiber. Shade: Aluminum  
 Diffuser: Methacrylate. Base: Steel.

**Light Source and electronics**  
 2 x LED 9 W 350 mA  
 Constant Current 350 mA  
 220~240V 50/60Hz

**Packaging**  
 10 Boxes  
 Total Vol 0,37 m³  
 Gross weight 92,05 Kg Net weight 79,95 Kg

**Notes**  
 Can be connected with or without plug.  
 Electric cable 2,5 m.

**UNTIL STOCK RUNS OUT**

5605

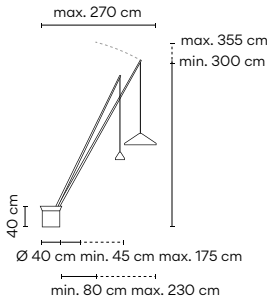

- Finishes**
- 10/ \_\_ White (NCS S 0300-N)
  - 11/ \_\_ Black (NCS S 8500 N)
  - 24/ \_\_ Beige M1 (NCS S 2005-Y50R)
  - 42 / \_\_ Blue M1 (NCS S 5010-B10G)

**LED temperature colour**  
 /1\_ 2700 K   
 CRI >90 2538,0 lm 141 lm/W

**Control**  
 5605 \_\_ / \_ 5  
 Push 3.650,00 €

**Materials**  
 Rods: Carbon fiber. Shade: Aluminum  
 Diffuser: Methacrylate. Base: Steel.

**Light Source and electronics**  
 2 x LED 9 W 350 mA  
 Constant Current 350 mA  
 220~240V 50/60Hz

**Packaging**  
 10 Boxes  
 Total Vol 0,35 m³  
 Gross weight 91 Kg Net weight 79,8 Kg

**Notes**  
 Can be connected with or without plug.  
 Electric cable 2,5 m

5620

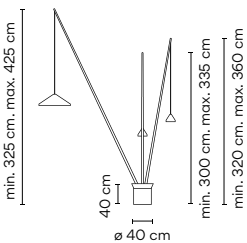

- Finishes**
- 10/ \_\_ White (NCS S 0300-N)
  - 11/ \_\_ Black (NCS S 8500 N)
  - 24/ \_\_ Beige M1 (NCS S 2005-Y50R)
  - 42 / \_\_ Blue M1 (NCS S 5010-B10G)

**LED temperature colour**  
 /1\_ 2700 K   
 CRI >90 3807 lm 141 lm/W

**Control**  
 5620 \_\_ / \_ 5  
 Push 4.330,00 €

**Materials**  
 Rods: Carbon fiber. Shade: Aluminum  
 Diffuser: Methacrylate. Base: Steel.

**Light Source and electronics**  
 3 x LED 9W 350mA  
 Constant Current 350 mA  
 220~240V 50/60Hz

**Packaging**  
 12 Boxes  
 Total Vol 0,36 m³  
 Gross weight 94,85 Kg Net weight 81,25 Kg

**Notes**  
 Can be connected with or without plug.  
 Electric cable 2,5 m

5625

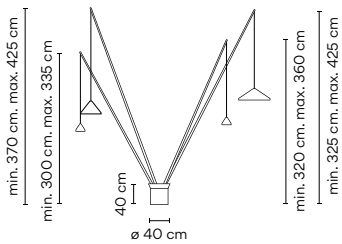

Finishes

- 10/ \_\_ White (NCS S 0300-N)
- 11/ \_\_ Black (NCS S 8500 N)
- 24/ \_\_ Beige M1 (NCS S 2005-Y50R)
- 42 / \_\_ Blue M1 (NCS S 5010-B10G)

LED temperature colour

- /1 \_ 2700 K
- CRI >90 5076 lm 141 lm/W

Control

- 5625 \_\_ / \_ 5
- Push

5.125,00 €

Materials

Rods: Carbon fiber. Shade: Aluminum  
Diffuser: Methacrylate. Base: Steel.

Light Source and electronics

4 x LED 9W 350mA  
Constant Current 350 mA  
220-240V 50/60Hz

Packaging

14 Boxes  
Total Vol 0,47 m<sup>3</sup>  
Gross weight 101,20 Kg Net weight 83,55 Kg

Notes

Can be connected with or without plug.  
Electric cable 2,5 m.

**UNTIL STOCK RUNS OUT**



5666

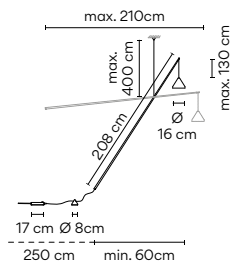

Finishes

- 10/ \_\_ White (NCS S 0300-N)
- 11/ \_\_ Black (NCS S 8500 N)
- 24/ \_\_ Beige M1 (NCS S 2005-Y50R)
- 42 / \_\_ Blue M1 (NCS S 5010-B10G)

LED temperature colour

- /1 \_ 2700 K
- CRI >90 1269,0 lm 141 lm/W
- /2 \_ 3000 K
- CRI >80 1123 lm 125 lm/W
- /3 \_ 3500 K
- CRI >90 1374,9 lm 152,8 lm/W

Control

- 5666 \_\_ / \_ 5
- Push

765,00 €

Materials

Rods: Carbon fiber. Shade: Aluminum  
Diffuser: Methacrylate. Counterweight: Aluminum

Light Source and electronics

1 x LED 9 W 350 mA  
Constant Current 350 mA  
110-240V 50/60Hz

Packaging

2 Boxes 0,24 x 0,217 x 0,21 m  
Total Vol 0,0464 m<sup>3</sup>  
Gross weight 6,2 Kg Net weight 4,05 Kg

Notes

Electric cable with plug.  
Electric cable 2,5 m  
Extra cable length. 16,00 €/m

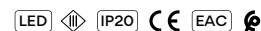

Height-adjustable shade.



Adjustable-angle rods.  
Can be connected with or without plug.



North

Wall



5630



5635



5640



5642



5644

5630

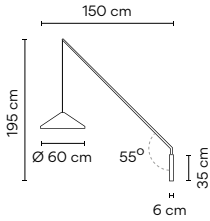

| Finishes                               | LED temperature colour                    |
|--|---|
| ● 10/ __ White<br>(NCS S 0300-N)       | /1 _ 2700 K  CRI >90 1269,0 lm 141 lm/W   |
| ● 11/ __ Black<br>(NCS S 8500 N)       | /2 _ 3000 K  CRI >80 1123 lm 125 lm/W     |
| ● 24/ __ Beige M1<br>(NCS S 2005-Y50R) | /3 _ 3500 K  CRI >90 1374,9 lm 152,8 lm/W |
| ● 42 / __ Blue M1<br>(NCS S 5010-B10G) |   |

**Materials**  
 Rods: Carbon fiber. Shade: Aluminum  
 Diffuser: Methacrylate. Wall Plate: Steel.

**Light Source and electronics**  
 1 x LED 9 W 350 mA  
 Constant Current 350 mA  
 110-240V 50/60Hz

**Control**  
 5630 \_\_ / \_ 5 1.525,00 €  
 Push

**Packaging**  
 3 Boxes  
 Total Vol 0,24 m<sup>3</sup>  
 Gross weight 11,05 Kg Net weight 5,85 Kg

**Notes**  
 Push-button on the wall plate.  
 Can be connected with or without plug.  
 Electric cable 2,5 m



5635

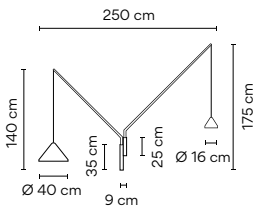

| Finishes                               | LED temperature colour                    |
|--|---|
| ● 10/ __ White<br>(NCS S 0300-N)       | /1 _ 2700 K  CRI >90 2538,0 lm 141 lm/W   |
| ● 11/ __ Black<br>(NCS S 8500 N)       | /2 _ 3000 K  CRI >80 2246 lm 125 lm/W     |
| ● 24/ __ Beige M1<br>(NCS S 2005-Y50R) | /3 _ 3500 K  CRI >90 2749,8 lm 152,8 lm/W |
| ● 42 / __ Blue M1<br>(NCS S 5010-B10G) |   |

**Materials**  
 Rods: Carbon fiber. Shade: Aluminum  
 Diffuser: Methacrylate. Wall Plate: Steel.

**Light Source and electronics**  
 2 x LED 9 W 350 mA  
 Constant Current 350 mA  
 220-240V 50/60Hz

**Control**  
 5635 \_\_ / \_ 5 2.115,00 €  
 Push

**Packaging**  
 4 Boxes  
 Total Vol 0,18 m<sup>3</sup>  
 Gross weight 14,6 Kg Net weight 7,3 Kg

**Notes**  
 Push-button on the wall plate.  
 Can be connected with or without plug.  
 Electric cable 2,5 m.

UNTIL STOCK RUNS OUT



5640

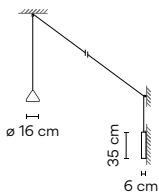

| Finishes                               | LED temperature colour                |
|--|---------------------------------------|
| ● 10/ __ White<br>(NCS S 0300-N)       | /1 _ 2700 K  CRI >90 1269 lm 141 lm/W |
| ● 11/ __ Black<br>(NCS S 8500 N)       |                                       |
| ● 24/ __ Beige M1<br>(NCS S 2005-Y50R) |                                       |
| ● 42 / __ Blue M1<br>(NCS S 5010-B10G) |                                       |

**Materials**  
 Diffuser: Methacrylate. Shade: Aluminum.  
 Wall Plate: Steel.

**Light Source and electronics**  
 1 x LED 9W 350 mA  
 Constant Current 350 mA  
 110-240V 50/60Hz

**Control**  
 5640 \_\_ / \_ 5 790,00 €  
 Push

**Packaging**  
 2 Boxes  
 Total Vol 0,04 m<sup>3</sup>  
 Gross weight 5,2 Kg Net weight 2,75 Kg

**Notes**  
 Push-button on the wall plate.  
 Can be connected with or without plug.  
 Electric cable 2,5 m.

UNTIL STOCK RUNS OUT



5642

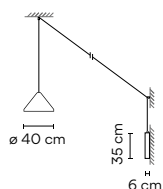

|  |  |                              |
|--|--|------------------------------|
| <b>Finishes</b>  | <b>LED temperature colour</b>  | <b>Control</b>               |
| <ul style="list-style-type: none"> <li>● 10/ __ White (NCS S 0300-N)</li> <li>● 11/ __ Black (NCS S 8500 N)</li> <li>● 24/ __ Beige M1 (NCS S 2005-Y50R)</li> <li>● 42 / __ Blue M1 (NCS S 5010-B10G)</li> </ul> | /1_ 2700 K <br>CRI >90 1269 lm 141 lm/W | <b>5642 __ / _ 5</b><br>Push |

885,00 €

**Materials**  
 Diffuser: Methacrylate. Shade: Aluminum.  
 Wall Plate: Steel.

**Light Source and electronics**  
 1 x LED 9W 350 mA  
 Constant Current 350 mA  
 110-240V 50/60Hz

**Packaging**  
 2 Boxes  
 Total Vol 0,12 m<sup>3</sup>  
 Gross weight 7,7 Kg Net weight 3,75 Kg

**Notes**  
 Push-button on the wall plate.  
 Length of light electric cable 10 m.  
 Can be connected with or without plug.  
 Electric cable 2,5 m.

UNTIL STOCK RUNS OUT



Dimmer Bi-volt

5644

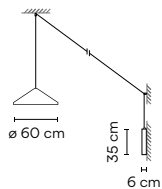

|  |  |                              |
|--|--|------------------------------|
| <b>Finishes</b>  | <b>LED temperature colour</b>  | <b>Control</b>               |
| <ul style="list-style-type: none"> <li>● 10/ __ White (NCS S 0300-N)</li> <li>● 11/ __ Black (NCS S 8500 N)</li> <li>● 24/ __ Beige M1 (NCS S 2005-Y50R)</li> <li>● 42 / __ Blue M1 (NCS S 5010-B10G)</li> </ul> | /1_ 2700 K <br>CRI >90 1269 lm 141 lm/W | <b>5644 __ / _ 5</b><br>Push |

1.035,00 €

**Materials**  
 Diffuser: Methacrylate. Shade: Aluminum.  
 Wall Plate: Steel.

**Light Source and electronics**  
 1 x LED 9W 350 mA  
 Constant Current 350 mA  
 110-240V 50/60Hz

**Packaging**  
 2 Boxes  
 Total Vol 0,20 m<sup>3</sup>  
 Gross weight 9,15 Kg Net weight 4,45 Kg

**Notes**  
 Push-button on the wall plate.  
 Length of light electric cable 10 m.  
 Can be connected with or without plug.  
 Electric cable 2,5 m.

UNTIL STOCK RUNS OUT

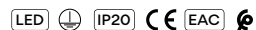

Dimmer Bi-volt



Height-adjustable shade.

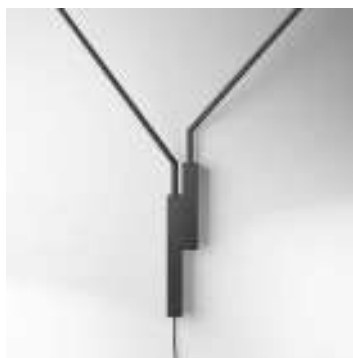

Can be connected with or without plug.





---

Pendants

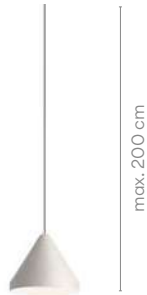

ø 16 cm

**5660**



ø 40 cm

**5662**



ø 60 cm

**5664**



ø 16 cm

**5670**



ø 40 cm

**5672**



ø 60 cm

**5674**



Height-adjustable shade.

### 5660

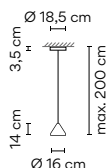

|                                     |                               |
|-------------------------------------|-------------------------------|
| <b>Finishes</b>                     | <b>LED temperature colour</b> |
| ● 10/ __ White (NCS S 0300-N)       | /1 _ 2700 K                   |
| ● 11/ __ Black (NCS S 8500 N)       | /2 _ 3000 K                   |
| ● 24/ __ Beige M1 (NCS S 2005-Y50R) | /3 _ 3500 K                   |
| ● 42 / __ Blue M1 (NCS S 5010-B10G) | CRI >90 1269,0 lm 141 lm/W    |
|                                     | CRI >80 1123 lm 125 lm/W      |
|                                     | CRI >90 1374,9 lm 152,8 lm/W  |

**Finish customization**  
(Available options:  
Vibia colour palette)

#### Materials

Shade: Aluminum  
Diffuser: Methacrylate. Canopy: Steel.

#### Light Source and electronics

1 x LED 9 W 350 mA  
Constant Current 350 mA  
110-240V 50/60Hz

#### Control

|                           |          |
|---------------------------|----------|
| 5660 __ / _ 1 DALI-2      | 575,00 € |
| 5660 __ / _ B 1-10V, Push | 545,00 € |
| 5660 __ / _ Z Casambi     | 665,00 € |

#### Packaging

1 Box 0,24 x 0,217 x 0,217 m  
Vol 0,01 m<sup>3</sup>  
Gross weight 2,3 Kg Net weight 1,25 Kg

#### Notes

Extra cable length. 16,00 €/m



#### Electrical connection

Surface  
\_18 Free Wire  
\_23 Built-in  
\_31 Remote Micro for plaster ceilings  
\_32 Remote XXS for all types of drop ceilings

### 5662

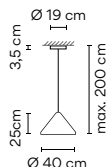

|                                     |                               |
|-------------------------------------|-------------------------------|
| <b>Finishes</b>                     | <b>LED temperature colour</b> |
| ● 10/ __ White (NCS S 0300-N)       | /1 _ 2700 K                   |
| ● 11/ __ Black (NCS S 8500 N)       | /2 _ 3000 K                   |
| ● 24/ __ Beige M1 (NCS S 2005-Y50R) | /3 _ 3500 K                   |
| ● 42 / __ Blue M1 (NCS S 5010-B10G) | CRI >90 1269,0 lm 141 lm/W    |
|                                     | CRI >80 1123 lm 125 lm/W      |
|                                     | CRI >90 1374,9 lm 152,8 lm/W  |

**Finish customization**  
(Available options:  
Vibia colour palette)

#### Materials

Shade: Aluminum  
Diffuser: Methacrylate. Canopy: Steel.

#### Light Source and electronics

1 x LED 9 W 350 mA  
Constant Current 350 mA  
220-240V 50/60Hz

#### Control

|                           |          |
|---------------------------|----------|
| 5662 __ / _ 1 DALI-2      | 695,00 € |
| 5662 __ / _ B 1-10V, Push | 660,00 € |
| 5662 __ / _ Z Casambi     | 780,00 € |

#### Packaging

1 Box 0,36 x 0,537 x 0,537 m  
Vol 0,10 m<sup>3</sup>  
Gross weight 4,8 Kg Net weight 2,25 Kg

#### Notes

Extra cable length. 16,00 €/m



#### Electrical connection

Surface  
\_18 Free Wire  
\_23 Built-in  
\_31 Remote Micro for plaster ceilings  
\_32 Remote XXS for all types of drop ceilings

### 5664

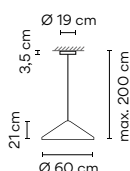

|                                     |                               |
|-------------------------------------|-------------------------------|
| <b>Finishes</b>                     | <b>LED temperature colour</b> |
| ● 10/ __ White (NCS S 0300-N)       | /1 _ 2700 K                   |
| ● 11/ __ Black (NCS S 8500 N)       | /2 _ 3000 K                   |
| ● 24/ __ Beige M1 (NCS S 2005-Y50R) | /3 _ 3500 K                   |
| ● 42 / __ Blue M1 (NCS S 5010-B10G) | CRI >90 1269,0 lm 141 lm/W    |
|                                     | CRI >80 1123 lm 125 lm/W      |
|                                     | CRI >90 1374,9 lm 152,8 lm/W  |

**Finish customization**  
(Available options:  
Vibia colour palette)

#### Materials

Shade: Aluminum  
Diffuser: Methacrylate. Canopy: Steel.

#### Light Source and electronics

1 x LED 9 W 350 mA  
Constant Current 350 mA  
110-240V 50/60Hz

#### Control

|                           |          |
|---------------------------|----------|
| 5664 __ / _ 1 DALI-2      | 835,00 € |
| 5664 __ / _ B 1-10V, Push | 795,00 € |
| 5664 __ / _ Z Casambi     | 915,00 € |

#### Packaging

1 Box 0,32 x 0,727 x 0,727 m  
Vol 0,17 m<sup>3</sup>  
Gross weight 6,25 Kg Net weight 2,95 Kg

#### Notes

Extra cable length. 16,00 €/m



#### Electrical connection

Surface  
\_18 Free Wire  
\_23 Built-in  
\_31 Remote Micro for plaster ceilings  
\_32 Remote XXS for all types of drop ceilings

## 5670

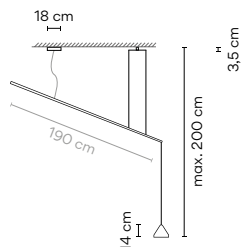

## Finishes

- 10/ \_\_ White (NCS S 0300-N)
- 11/ \_\_ Black (NCS S 8500 N)
- 24/ \_\_ Beige M1 (NCS S 2005-Y50R)
- 42 / \_\_ Blue M1 (NCS S 5010-B10G)

## LED temperature colour

- /1\_ 2700 K
  - /2\_ 3000 K
  - /3\_ 3500 K
- CRI >90 1269,0 lm 141 lm/W  
CRI >80 1123 lm 125 lm/W  
CRI >90 1374,9 lm 152,8 lm/W

## Control

- |               |            |
|---------------|------------|
| 5670 __ / _ 1 | 1.035,00 € |
| DALI-2        |            |
| 5670 __ / _ B | 985,00 €   |
| 1-10V, Push   |            |
| 5670 __ / _ Z | 1.105,00 € |
| Casambi       |            |

## Materials

Rods: Carbon fiber. Shade: Aluminum  
Diffuser: Methacrylate. Canopy: Steel.

## Light Source and electronics

1 x LED 9 W 350 mA  
Constant Current 350 mA  
110-240V 50/60Hz

## Packaging

2 Boxes  
Total Vol 0,06 m<sup>3</sup>  
Gross weight 5,75 Kg Net weight 2 Kg

## Notes

Extra cable length. 16,00 €/m

## 5672

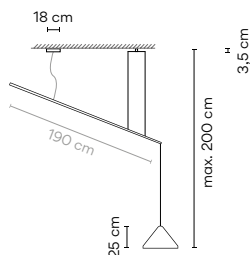

## Finishes

- 10/ \_\_ White (NCS S 0300-N)
- 11/ \_\_ Black (NCS S 8500 N)
- 24/ \_\_ Beige M1 (NCS S 2005-Y50R)
- 42 / \_\_ Blue M1 (NCS S 5010-B10G)

## LED temperature colour

- /1\_ 2700 K
  - /2\_ 3000 K
  - /3\_ 3500 K
- CRI >90 1269,0 lm 141 lm/W  
CRI >80 1123 lm 125 lm/W  
CRI >90 1374,9 lm 152,8 lm/W

## Control

- |               |            |
|---------------|------------|
| 5672 __ / _ 1 | 1.115,00 € |
| DALI-2        |            |
| 5672 __ / _ B | 1.060,00 € |
| 1-10V, Push   |            |
| 5672 __ / _ Z | 1.180,00 € |
| Casambi       |            |

## Materials

Rods: Carbon fiber. Shade: Aluminum  
Diffuser: Methacrylate. Canopy: Steel.

## Light Source and electronics

1 x LED 9W 350 mA  
Constant Current 350 mA  
110-240V 50/60Hz

## Packaging

2 Boxes  
Total Vol 0,14 m<sup>3</sup>  
Gross weight 8,25 Kg Net weight 3 Kg

## Notes

Extra cable length. 16,00 €/m

## 5674

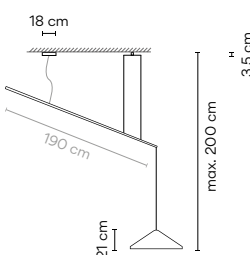

## Finishes

- 10/ \_\_ White (NCS S 0300-N)
- 11/ \_\_ Black (NCS S 8500 N)
- 24/ \_\_ Beige M1 (NCS S 2005-Y50R)
- 42 / \_\_ Blue M1 (NCS S 5010-B10G)

## LED temperature colour

- /1\_ 2700 K
  - /2\_ 3000 K
  - /3\_ 3500 K
- CRI >90 1269,0 lm 141 lm/W  
CRI >80 1123 lm 125 lm/W  
CRI >90 1374,9 lm 152,8 lm/W

## Control

- |               |            |
|---------------|------------|
| 5674 __ / _ 1 | 1.255,00 € |
| DALI-2        |            |
| 5674 __ / _ B | 1.195,00 € |
| 1-10V, Push   |            |
| 5674 __ / _ Z | 1.315,00 € |
| Casambi       |            |

## Materials

Rods: Carbon fiber. Shade: Aluminum  
Diffuser: Methacrylate. Canopy: Steel.

## Light Source and electronics

1 x LED 9 W 350 mA  
Constant Current 350 mA  
110-240V 50/60Hz

## Packaging

2 Boxes  
Total Vol 0,21 m<sup>3</sup>  
Gross weight 9,7 Kg Net weight 3,7 Kg

## Notes

Extra cable length. 16,00 €/m

# Composing pendants

Next sketches are composed by one or more compositions

---

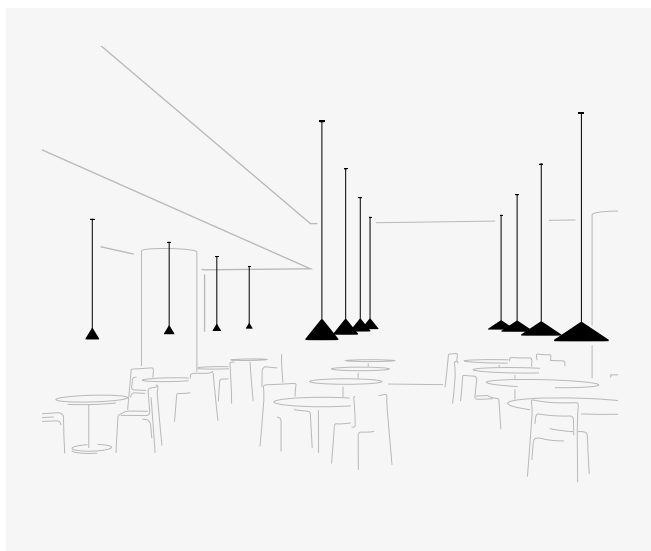

4 x 5660.  
4 x 5662.  
4 x 5664.

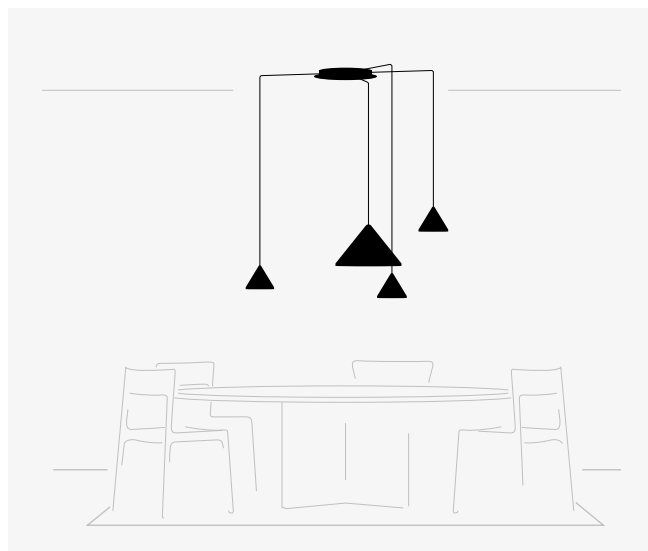

1 x 5664.  
3 x 5660.

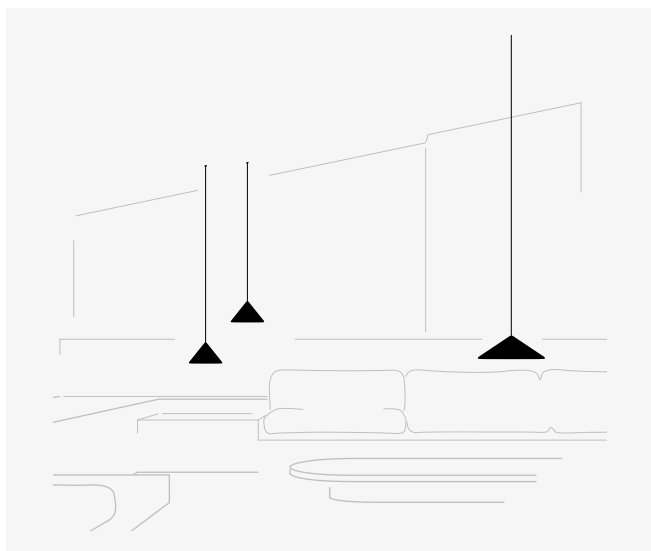

2 x 5662.  
1 x 5664.

Each project is unique.  
Visit [vibia.com](http://vibia.com) and  
chose among multiple  
compositions designed  
and adapted to your  
project needs.

Personalise your own  
North composition quick  
and easy at [vibia.com](http://vibia.com)

# Electrical connection options for models 5660 / 5662 / 5664

Choose your preferred installation option  
according to your needs.  
For each composition, the optimal minimum  
number of drivers will be delivered.

## Drop ceiling

The innovative remote and built-in fittings accentuate  
the silkiness and lightness of compositions on  
suspended ceilings, its great visual grandeur taking  
center stage.

For Ref. 5660 / 5662 / 5664

### Remote

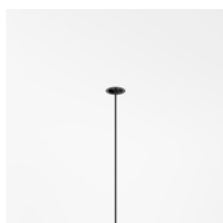

**Micro** ø 3 cm  
height 7 cm  
for plaster ceilings.  
Black finish.

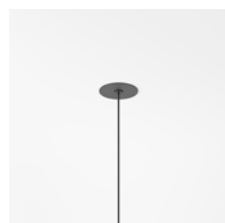
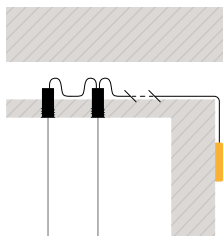

**XXS** ø 6 cm  
height 6 cm  
for all types of drop  
ceilings. Match with  
fixture finish.

### Built-in



ø 8 cm  
height 6 cm  
match with  
fixture finish.

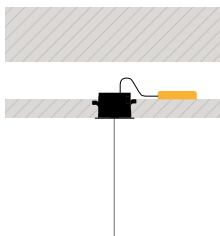

## Regular ceiling

When architecture does not allow for performance, surface and free wire showcase possibilities for any need or desire with no limits, ideal for both individual or cluster arrangements.

For Ref. 5660 / 5662 / 5664

### Surface



ø 18 cm

match with  
fixture finish.

### Free Wire



1 wire

ø 20 cm



2 wires

ø 22 cm



3 - 6 wires

ø 36 cm



7 - 8 wires

ø 40 cm

you can choose the finish of the canopy  
among black, white or any colour  
matching one of the pendants.

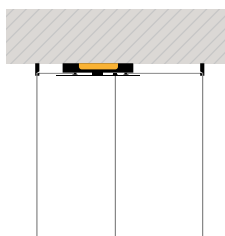
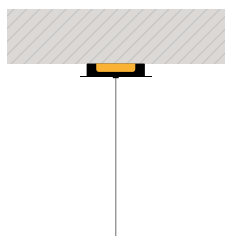

# Tempo

Design by Lievore, Altherr

Timeless character. The Tempo collection by Lievore Altherr reclaims our collective memory of light, making it contemporary through its most essential expression. Shades with an architectonic profile recreate different ambiances bringing them right up-to-date with new additions and uses.

---

## Wall



5756 5757



5758 5759

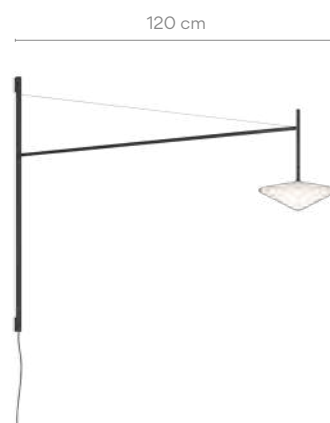

5760 5761



5762 5763



5764 5765



5766 5767





Ref.  
5757, 5759, 5761, 5763, 5765, 5767.  
Recessed dimmable driver.



Ref.  
5756, 5758, 5760, 5762, 5764, 5766.  
Push dimmer on the cable.  
With plug.

5756

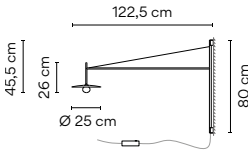

|                                     |                                     |                    |          |
|-------------------------------------|-------------------------------------|--------------------|----------|
| <b>Finishes</b>                     | <b>LED temperature colour</b>       | <b>Control</b>     |          |
| ● 18/ __ Graphite (ADAPTA RF9913WX) | /1_ 2700 K  CRI >90 415 lm 104 lm/W | 5756 __ / _ 5 Push | 980,00 € |

- 37/ \_\_ Terra Red (NCS S 4040-Y70R)
- 58/ \_\_ Cream (RAL 7044)
- 62/ \_\_ Green (NCS S 3010-G20Y)

**Materials**

Diffuser: Blown-glass. LED support: Aluminum.  
Structures: Steel. Shade: Aluminum.

**Light Source and electronics**

1 x LED 4 W 350 mA  
Constant Current 350 mA  
220~240V 50/60Hz

**Packaging**

2 Boxes  
Total Vol 0,082 m<sup>3</sup>  
Gross weight 4,3 Kg Net weight 2,5 Kg

**Notes**

Push dimmer on the cable. With plug (4 m)

LED IP20 Dimmer

5757

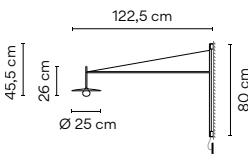

|                                     |                                     |                      |          |
|-------------------------------------|-------------------------------------|----------------------|----------|
| <b>Finishes</b>                     | <b>LED temperature colour</b>       | <b>Control</b>       |          |
| ● 18/ __ Graphite (ADAPTA RF9913WX) | /1_ 2700 K  CRI >90 415 lm 104 lm/W | 5757 __ / _ 1 DALI-2 | 980,00 € |

- 37/ \_\_ Terra Red (NCS S 4040-Y70R)
- 58/ \_\_ Cream (RAL 7044)
- 62/ \_\_ Green (NCS S 3010-G20Y)

**Materials**

Diffuser: Blown-glass. LED support: Aluminum.  
Structures: Steel. Shade: Aluminum.

**Light Source and electronics**

1 x LED 4 W 350 mA  
Constant Current 350 mA  
220~240V 50/60Hz

**Packaging**

2 Boxes  
Total Vol 0,082 m<sup>3</sup>  
Gross weight 4,3 Kg Net weight 2,5 Kg

**Notes**

Recessed dimmable driver (2,5 m)

LED IP20 ø 7,5 cm

**5758**

**Finishes**

- **18/** \_\_ Graphite (ADAPTA RF9913WX)
- **37/** \_\_ Terra Red (NCS S 4040-Y70R)
- **58/** \_\_ Cream (RAL 7044)
- **62/** \_\_ Green (NCS S 3010-G20Y)

**LED temperature colour**

/1\_ 2700 K CRI >90 415 lm 104 lm/W

**Control**

**5758** \_\_ / \_ 5 995,00 €  
Push

---

**Materials**

Diffuser: Blown-glass. LED support: Aluminum.  
Structures: Steel.

**Light Source and electronics**

1 x LED 4 W 350 mA  
Constant Current 350 mA  
220-240V 50/60Hz

**Packaging**

2 Boxes  
Total Vol 0,088 m<sup>3</sup>  
Gross weight 3,5 Kg Net weight 1,7 Kg

**Notes**

Push dimmer on the cable. With plug (4 m).

**5759**

**Finishes**

- **18/** \_\_ Graphite (ADAPTA RF9913WX)
- **37/** \_\_ Terra Red (NCS S 4040-Y70R)
- **58/** \_\_ Cream (RAL 7044)
- **62/** \_\_ Green (NCS S 3010-G20Y)

**LED temperature colour**

/1\_ 2700 K CRI >90 415 lm 104 lm/W

**Control**

**5759** \_\_ / \_ 1 1000,00 €  
DALI-2

**5759** \_\_ / \_ B 950,00 €  
1-10V, Push

**5759** \_\_ / \_ Z 1.070,00 €  
Casambi

---

**Materials**

Diffuser: Blown-glass. LED support: Aluminum.  
Structures: Steel.

**Light Source and electronics**

1 x LED 4 W 350 mA  
Constant Current 350 mA  
220-240V 50/60Hz

**Packaging**

2 Boxes  
Total Vol 0,088 m<sup>3</sup>  
Gross weight 3,5 Kg Net weight 1,7 Kg

**Notes**

Recessed dimmable driver (2,5 m)

ø 7,5 cm

**5760**

**Finishes**

- **18/** \_\_ Graphite (ADAPTA RF9913WX)
- **37/** \_\_ Terra Red (NCS S 4040-Y70R)
- **58/** \_\_ Cream (RAL 7044)
- **62/** \_\_ Green (NCS S 3010-G20Y)

**LED temperature colour**

/1\_ 2700 K CRI >90 415 lm 104 lm/W

**Control**

**5760** \_\_ / \_ 5 980,00 €  
Push

---

**Materials**

Diffuser: Blown-glass. LED support: Aluminum.  
Structures: Steel.

**Light Source and electronics**

1 x LED 4 W 350 mA  
Constant Current 350 mA  
220-240V 50/60Hz

**Packaging**

2 Boxes  
Total Vol 0,088 m<sup>3</sup>  
Gross weight 3,7 Kg Net weight 1,9 Kg

**Notes**

Push dimmer on the cable. With plug (4 m)

**5761**

**Finishes**

- **18/** \_\_ Graphite (ADAPTA RF9913WX)
- **37/** \_\_ Terra Red (NCS S 4040-Y70R)
- **58/** \_\_ Cream (RAL 7044)
- **62/** \_\_ Green (NCS S 3010-G20Y)

**LED temperature colour**

/1\_ 2700 K CRI >90 415 lm 104 lm/W

**Control**

**5761** \_\_ / \_ 1 980,00 €  
DALI-2

**5761** \_\_ / \_ B 930,00 €  
1-10V, Push

**5761** \_\_ / \_ Z 1.050,00 €  
Casambi

---

**Materials**

Diffuser: Blown-glass. LED support: Aluminum.  
Structures: Steel.

**Light Source and electronics**

1 x LED 4 W 350 mA  
Constant Current 350 mA  
220-240V 50/60Hz

**Packaging**

2 Boxes  
Total Vol 0,088 m<sup>3</sup>  
Gross weight 3,7 Kg Net weight 1,9 Kg

**Notes**

Recessed dimmable driver (2,5 m)

ø 7,5 cm

5762

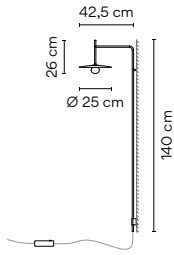

|   |                                       |                       |          |
|---|---------------------------------------|-----------------------|----------|
| <b>Finishes</b>                         | <b>LED temperature colour</b>         | <b>Control</b>        |          |
| ● 18/ __ Graphite<br>(ADAPTA RF9913WX)  | /1_ 2700 K<br>CRI >90 415 lm 104 lm/W | 5762 __ / _ 5<br>Push | 795,00 € |
| ● 37/ __ Terra Red<br>(NCS S 4040-Y70R) |                                       |                       |          |
| ● 58/ __ Cream<br>(RAL 7044)            |                                       |                       |          |
| ● 62/ __ Green<br>(NCS S 3010-G20Y)     |                                       |                       |          |

**Materials**  
 Diffuser: Blown-glass. LED support: Aluminum.  
 Structures: Steel. Shade: Aluminum

**Light Source and electronics**  
 1 x LED 4 W 350 mA  
 Constant Current 350 mA  
 220~240V 50/60Hz

**Packaging**  
 2 Boxes  
 Total Vol 0,088 m<sup>3</sup>  
 Gross weight 3,2 Kg Net weight 2 Kg

**Notes**  
 Push dimmer on the cable. With plug (4 m)



5763

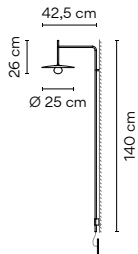

|   |                                       |                              |          |
|---|---------------------------------------|------------------------------|----------|
| <b>Finishes</b>                         | <b>LED temperature colour</b>         | <b>Control</b>               |          |
| ● 18/ __ Graphite<br>(ADAPTA RF9913WX)  | /1_ 2700 K<br>CRI >90 415 lm 104 lm/W | 5763 __ / _ 1<br>DALI-2      | 805,00 € |
| ● 37/ __ Terra Red<br>(NCS S 4040-Y70R) |                                       | 5763 __ / _ B<br>1-10V, Push | 765,00 € |
| ● 58/ __ Cream<br>(RAL 7044)            |                                       | 5763 __ / _ Z<br>Casambi     | 885,00 € |
| ● 62/ __ Green<br>(NCS S 3010-G20Y)     |                                       |                              |          |

**Materials**  
 Diffuser: Blown-glass. LED support: Aluminum.  
 Structures: Steel. Shade: Aluminum

**Light Source and electronics**  
 1 x LED 4 W 350 mA  
 Constant Current 350 mA  
 220~240V 50/60Hz

**Packaging**  
 2 Boxes  
 Total Vol 0,088 m<sup>3</sup>  
 Gross weight 3,2 Kg Net weight 2 Kg

**Notes**  
 Recessed dimmable driver (2,5 m)



5764

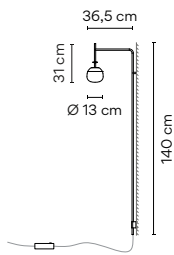

|   |                                       |                       |          |
|---|---------------------------------------|-----------------------|----------|
| <b>Finishes</b>                         | <b>LED temperature colour</b>         | <b>Control</b>        |          |
| ● 18/ __ Graphite<br>(ADAPTA RF9913WX)  | /1_ 2700 K<br>CRI >90 415 lm 104 lm/W | 5764 __ / _ 5<br>Push | 810,00 € |
| ● 37/ __ Terra Red<br>(NCS S 4040-Y70R) |                                       |                       |          |
| ● 58/ __ Cream<br>(RAL 7044)            |                                       |                       |          |
| ● 62/ __ Green<br>(NCS S 3010-G20Y)     |                                       |                       |          |

**Materials**  
 Diffuser: Blown-glass. LED support: Aluminum.  
 Structures: Steel.

**Light Source and electronics**  
 1 x LED 4 W 350 mA  
 Constant Current 350 mA  
 220~240V 50/60Hz

**Packaging**  
 2 Boxes  
 Total Vol 0,088 m<sup>3</sup>  
 Gross weight 2,45 Kg Net weight 1,25 Kg

**Notes**  
 Push dimmer on the cable. With plug (4 m)



5765

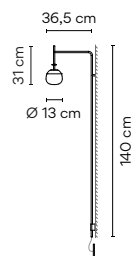

|   |                                       |                              |          |
|---|---------------------------------------|------------------------------|----------|
| <b>Finishes</b>                         | <b>LED temperature colour</b>         | <b>Control</b>               |          |
| ● 18/ __ Graphite<br>(ADAPTA RF9913WX)  | /1_ 2700 K<br>CRI >90 415 lm 104 lm/W | 5765 __ / _ 1<br>DALI-2      | 820,00 € |
| ● 37/ __ Terra Red<br>(NCS S 4040-Y70R) |                                       | 5765 __ / _ B<br>1-10V, Push | 780,00 € |
| ● 58/ __ Cream<br>(RAL 7044)            |                                       | 5765 __ / _ Z<br>Casambi     | 900,00 € |
| ● 62/ __ Green<br>(NCS S 3010-G20Y)     |                                       |                              |          |

**Materials**  
 Diffuser: Blown-glass. LED support: Aluminum.  
 Structures: Steel.

**Light Source and electronics**  
 1 x LED 4 W 350 mA  
 Constant Current 350 mA  
 220~240V 50/60Hz

**Packaging**  
 2 Boxes  
 Total Vol 0,088 m<sup>3</sup>  
 Gross weight 2,45 Kg Net weight 1,25 Kg

**Notes**  
 Recessed dimmable driver (2,5 m)



5766

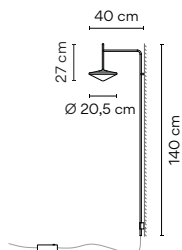

|  |   |   |                 |
|--|---|---|-----------------|
| <b>Finishes</b>  | <b>LED temperature colour</b>   | <b>Control</b>  |                 |
| <ul style="list-style-type: none"> <li>● <b>18/</b> _ _ Graphite (ADAPTA RF9913WX)</li> <li>● <b>37/</b> _ _ Terra Red (NCS S 4040-Y70R)</li> <li>● <b>58/</b> _ _ Cream (RAL 7044)</li> <li>● <b>62/</b> _ _ Green (NCS S 3010-G20Y)</li> </ul> | <ul style="list-style-type: none"> <li><b>/1</b> _ 2700 K </li> <li>CRI &gt;90 415 lm 104 lm/W</li> </ul> | <ul style="list-style-type: none"> <li><b>5766</b> _ _ / _ 5</li> <li>Push</li> </ul> | <b>795,00 €</b> |
| <b>Materials</b>   |   | <b>Packaging</b>  |                 |
| Diffuser: Blown-glass. LED support: Aluminum. Structures: Steel.   |   | 2 Boxes<br>Total Vol 0,088 m <sup>3</sup><br>Gross weight 2,65 Kg Net weight 1,45 Kg  |                 |
| <b>Light Source and electronics</b>  |   | <b>Notes</b>  |                 |
| 1 x LED 4 W 350 mA<br>Constant Current 350 mA<br>220~240V 50/60Hz  |   | Push dimmer on the cable. With plug (4 m)   |                 |



5767

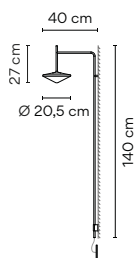

|  |   |   |   |
|--|---|---|---|
| <b>Finishes</b>  | <b>LED temperature colour</b>   | <b>Control</b>  |   |
| <ul style="list-style-type: none"> <li>● <b>18/</b> _ _ Graphite (ADAPTA RF9913WX)</li> <li>● <b>37/</b> _ _ Terra Red (NCS S 4040-Y70R)</li> <li>● <b>58/</b> _ _ Cream (RAL 7044)</li> <li>● <b>62/</b> _ _ Green (NCS S 3010-G20Y)</li> </ul> | <ul style="list-style-type: none"> <li><b>/1</b> _ 2700 K </li> <li>CRI &gt;90 415 lm 104 lm/W</li> </ul> | <ul style="list-style-type: none"> <li><b>5767</b> _ _ / _ 1</li> <li>DALI-2</li> <li><b>5767</b> _ _ / _ B</li> <li>1-10V, Push</li> <li><b>5767</b> _ _ / _ Z</li> <li>Casambi</li> </ul> | <ul style="list-style-type: none"> <li><b>805,00 €</b></li> <li><b>765,00 €</b></li> <li><b>885,00 €</b></li> </ul> |
| <b>Materials</b>   |   | <b>Packaging</b>  |   |
| Diffuser: Blown-glass. LED support: Aluminum. Structures: Steel.   |   | 2 Boxes<br>Total Vol 0,088 m <sup>3</sup><br>Gross weight 2,65 Kg Net weight 1,45 Kg  |   |
| <b>Light Source and electronics</b>  |   | <b>Notes</b>  |   |
| 1 x LED 4 W 350 mA<br>Constant Current 350 mA<br>220~240V 50/60Hz  |   | Recessed dimmable driver (2,5 cm)   |   |



Pendants



ø 25 cm

**5770**



ø 13 cm

**5772**



ø 20,5 cm

**5774**

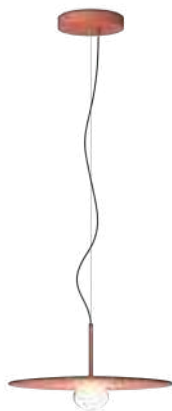

ø 40 cm

**5776**



ø 24 cm

**5778**



ø 34,5 cm

**5780**

5770

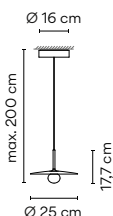

- |   |                               |
|---|-------------------------------|
| <b>Finishes</b>                             | <b>LED temperature colour</b> |
| ● <b>18/</b> __ Graphite (ADAPTA RF9913WX)  | <b>/1_</b> 2700 K             |
| ● <b>37/</b> __ Terra Red (NCS S 4040-Y70R) | CRI >90 415 lm 104 lm/W       |
| ● <b>58/</b> __ Cream (RAL 7044)            |                               |
| ● <b>62/</b> __ Green (NCS S 3010-G20Y)     |                               |

**Materials**  
 Diffuser: Blown-glass. LED support: Aluminum.  
 Structures: Steel. Shade: Aluminum. Canopy: Steel.

**Light Source and electronics**  
 1 x LED 4 W 350 mA  
 Constant Current 350 mA  
 110-240V 50/60Hz

|                                  |                 |
|----------------------------------|-----------------|
| <b>Control</b>                   |                 |
| <b>5770</b> __ / _ 1 DALI-2      | <b>640,00 €</b> |
| <b>5770</b> __ / _ B 1-10V, Push | <b>605,00 €</b> |
| <b>5770</b> __ / _ Z Casambi     | <b>725,00 €</b> |

**Packaging**  
 1 Box 0,28 x 0,26 x 0,13 m  
 Vol 0,01 m<sup>3</sup>  
 Gross weight 2,5 Kg Net weight 2 Kg

**Notes**  
 Extra cable length. **16,00 €/m**



**Electrical connection**  
 Surface  
 \_18 Free Wire  
 \_23 Built-in  
 \_31 Remote Micro for plaster ceilings  
 \_32 Remote XXS for all types of drop ceilings

5772

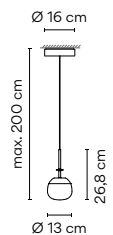

- |   |                               |
|---|-------------------------------|
| <b>Finishes</b>                             | <b>LED temperature colour</b> |
| ● <b>18/</b> __ Graphite (ADAPTA RF9913WX)  | <b>/1_</b> 2700 K             |
| ● <b>37/</b> __ Terra Red (NCS S 4040-Y70R) | CRI >90 415 lm 104 lm/W       |
| ● <b>58/</b> __ Cream (RAL 7044)            |                               |
| ● <b>62/</b> __ Green (NCS S 3010-G20Y)     |                               |

**Materials**  
 Diffuser: Blown-glass. LED support: Aluminum.  
 Structures: Steel. Shade: Aluminum. Canopy: Steel.

**Light Source and electronics**  
 1 x LED 4 W 350 mA  
 Constant Current 350 mA  
 110-240V 50/60Hz

|                                  |                 |
|----------------------------------|-----------------|
| <b>Control</b>                   |                 |
| <b>5772</b> __ / _ 1 DALI-2      | <b>650,00 €</b> |
| <b>5772</b> __ / _ B 1-10V, Push | <b>615,00 €</b> |
| <b>5772</b> __ / _ Z Casambi     | <b>735,00 €</b> |

**Packaging**  
 1 Box 0,28 x 0,2 x 0,27 m  
 Vol 0,015 m<sup>3</sup>  
 Gross weight 1,8 Kg Net weight 1,2 Kg

**Notes**  
 Extra cable length. **16,00 €/m**



**Electrical connection**  
 Surface  
 \_18 Free Wire  
 \_23 Built-in  
 \_31 Remote Micro for plaster ceilings  
 \_32 Remote XXS for all types of drop ceilings

5774

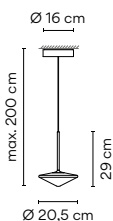

- |   |                               |
|---|-------------------------------|
| <b>Finishes</b>                             | <b>LED temperature colour</b> |
| ● <b>18/</b> __ Graphite (ADAPTA RF9913WX)  | <b>/1_</b> 2700 K             |
| ● <b>37/</b> __ Terra Red (NCS S 4040-Y70R) | CRI >90 415 lm 104 lm/W       |
| ● <b>58/</b> __ Cream (RAL 7044)            |                               |
| ● <b>62/</b> __ Green (NCS S 3010-G20Y)     |                               |

**Materials**  
 Diffuser: Blown-glass. LED support: Aluminum.  
 Structures: Steel. Shade: Aluminum. Canopy: Steel.

**Light Source and electronics**  
 1 x LED 4 W 350 mA  
 Constant Current 350 mA  
 110-240V 50/60Hz

|                                  |                 |
|----------------------------------|-----------------|
| <b>Control</b>                   |                 |
| <b>5774</b> __ / _ 1 DALI-2      | <b>640,00 €</b> |
| <b>5774</b> __ / _ B 1-10V, Push | <b>605,00 €</b> |
| <b>5774</b> __ / _ Z Casambi     | <b>725,00 €</b> |

**Packaging**  
 1 Box 0,28 x 0,2 x 0,27 m  
 Vol 0,015 m<sup>3</sup>  
 Gross weight 2 Kg Net weight 1,4 Kg

**Notes**  
 Extra cable length. **16,00 €/m**



**Electrical connection**  
 Surface  
 \_18 Free Wire  
 \_23 Built-in  
 \_31 Remote Micro for plaster ceilings  
 \_32 Remote XXS for all types of drop ceilings

5776

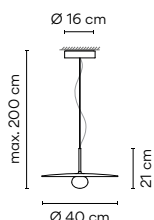

|  |  |
|--|--|
| <b>Finishes</b>                                | <b>LED temperature colour</b>                |
| ● <b>18/</b> __ Graphite<br>(ADAPTA RF9913WX)  | <b>/1_</b> 2700 K<br>CRI >90 415 lm 104 lm/W |
| ● <b>37/</b> __ Terra Red<br>(NCS S 4040-Y70R) |  |
| ● <b>58/</b> __ Cream<br>(RAL 7044)            |  |
| ● <b>62/</b> __ Green<br>(NCS S 3010-G20Y)     |  |

|                                     |                 |
|-------------------------------------|-----------------|
| <b>Control</b>                      |                 |
| <b>5776</b> __ / _ 1<br>DALI-2      | <b>785,00 €</b> |
| <b>5776</b> __ / _ B<br>1-10V, Push | <b>745,00 €</b> |
| <b>5776</b> __ / _ Z<br>Casambi     | <b>865,00 €</b> |

**Materials**  
Diffuser: Blown-glass. LED support: Aluminum.  
Structures: Steel. Shade: Aluminum. Canopy: Steel.

**Packaging**  
1 Box 0,45 x 0,45 x 0,12 m  
Vol 0,023 m<sup>3</sup>  
Gross weight 5,5 Kg Net weight 4 Kg

**Light Source and electronics**  
1 x LED 4 W 350 mA  
Constant Current 350 mA  
110-240V 50/60Hz

**Notes**  
Extra cable length. **16,00 €/m**



5778

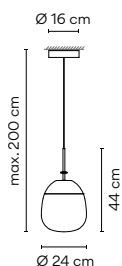

|  |  |
|--|--|
| <b>Finishes</b>                                | <b>LED temperature colour</b>                |
| ● <b>18/</b> __ Graphite<br>(ADAPTA RF9913WX)  | <b>/1_</b> 2700 K<br>CRI >90 415 lm 104 lm/W |
| ● <b>37/</b> __ Terra Red<br>(NCS S 4040-Y70R) |  |
| ● <b>58/</b> __ Cream<br>(RAL 7044)            |  |
| ● <b>62/</b> __ Green<br>(NCS S 3010-G20Y)     |  |

|                                     |                 |
|-------------------------------------|-----------------|
| <b>Control</b>                      |                 |
| <b>5778</b> __ / _ 1<br>DALI-2      | <b>795,00 €</b> |
| <b>5778</b> __ / _ B<br>1-10V, Push | <b>755,00 €</b> |
| <b>5778</b> __ / _ Z<br>Casambi     | <b>875,00 €</b> |

**Materials**  
Diffuser: Blown-glass. LED support: Aluminum.  
Structure: Steel. Canopy: Steel.

**Packaging**  
1 Box 0,33 x 0,33 x 0,42 m  
Vol 0,045 m<sup>3</sup>  
Gross weight 4 Kg Net weight 2,5 Kg

**Light Source and electronics**  
1 x LED 4 W 350 mA  
Constant Current 350 mA  
110-240V 50/60Hz

**Notes**  
Extra cable length. **16,00 €/m**

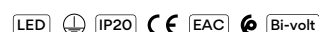

5780

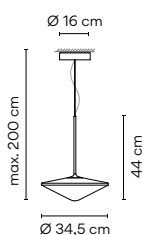

|  |  |
|--|--|
| <b>Finishes</b>                                | <b>LED temperature colour</b>                |
| ● <b>18/</b> __ Graphite<br>(ADAPTA RF9913WX)  | <b>/1_</b> 2700 K<br>CRI >90 415 lm 104 lm/W |
| ● <b>37/</b> __ Terra Red<br>(NCS S 4040-Y70R) |  |
| ● <b>58/</b> __ Cream<br>(RAL 7044)            |  |
| ● <b>62/</b> __ Green<br>(NCS S 3010-G20Y)     |  |

|                                     |                 |
|-------------------------------------|-----------------|
| <b>Control</b>                      |                 |
| <b>5780</b> __ / _ 1<br>DALI-2      | <b>785,00 €</b> |
| <b>5780</b> __ / _ B<br>1-10V, Push | <b>745,00 €</b> |
| <b>5780</b> __ / _ Z<br>Casambi     | <b>865,00 €</b> |

**Materials**  
Diffuser: Blown-glass. LED support: Aluminum.  
Structures: Steel. Shade: Aluminum. Canopy: Steel.

**Packaging**  
1 Box 0,41 x 0,41 x 0,23 m  
Vol 0,038 m<sup>3</sup>  
Gross weight 4 Kg Net weight 2,5 Kg

**Light Source and electronics**  
1 x LED 4 W 350 mA  
Constant Current 350 mA  
110-240V 50/60Hz

**Notes**  
Extra cable length. **16,00 €/m**



# Composing pendants

Next sketches are composed by one or more compositions

---

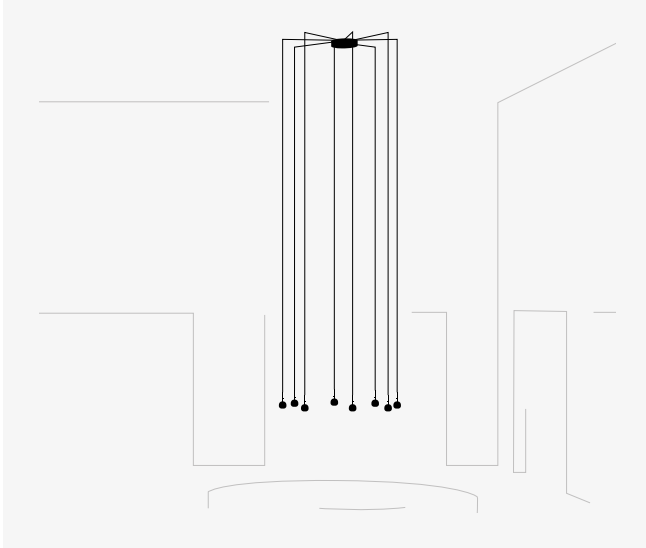

8 x 5772.

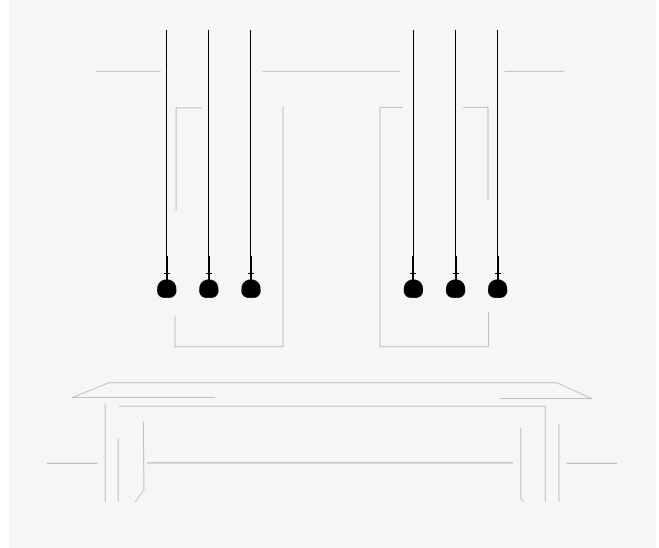

6 x 5772.

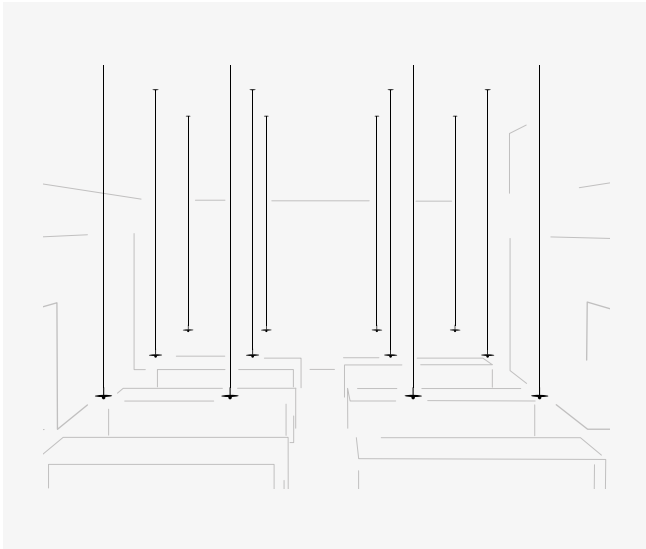

12 x 5770.

Each project is unique.  
Visit [vibia.com](http://vibia.com) and  
choose among multiple  
compositions designed  
and adapted to your  
project needs.

Personalise your own  
Tempo composition quick  
and easy at [vibia.com](http://vibia.com)





# Electrical connection options for models 5770 / 5772 / 5774

Choose your preferred installation option  
according to your needs.  
For each composition, the optimal minimum  
number of drivers will be delivered.

## Drop ceiling

The innovative remote and built-in fittings accentuate  
the silkiness and lightness of compositions on  
suspended ceilings, its great visual grandeur taking  
center stage.

For Ref. 5770 / 5772 / 5774

### Remote

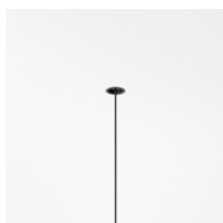

**Micro**  $\varnothing$  3 cm  
height 7 cm  
for plaster ceilings.  
Black finish.

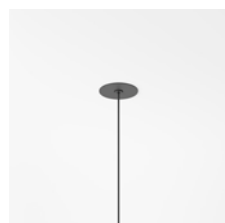
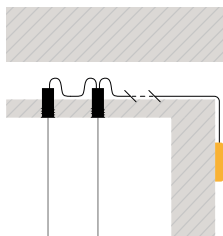

**XXS**  $\varnothing$  6 cm  
height 6 cm  
for all types of drop  
ceilings. Match with  
fixture finish.

### Built-in



$\varnothing$  8 cm  
height 6 cm  
match with  
fixture finish.

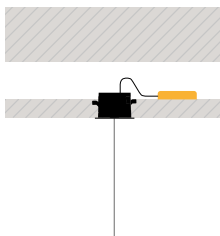

---

## Regular ceiling

When architecture does not allow for performance, surface and free wire showcase possibilities for any need or desire with no limits, ideal for both individual or cluster arrangements.

For Ref. 5770 / 5772 / 5774

### Surface



ø 16 cm  
match with  
fixture finish.

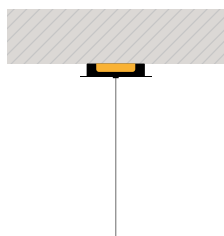

### Free Wire

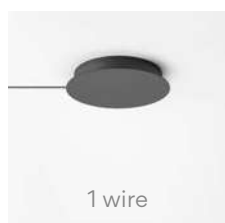

1 wire

ø 20 cm



2 - 6 wires

ø 36 cm



7 - 9 wires

ø 40 cm

you can choose the finish of the canopy  
among black, white or any colour  
matching one of the pendants.

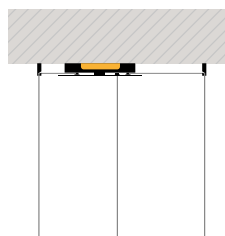

# Flat

Design by Ichiro Iwasaki

Flat's distinctive, disc-shaped diffusers form horizontal planes of light that integrate with the surrounding architecture. A study in geometry, the collection creates layers of light that infuse a space with a soothing, Zen sensitivity.

---

## Ceiling



ø 40 cm

**5920**



ø 55 cm

**5915**



ø 90 cm

**5926**



101 x 88 cm

**5905**

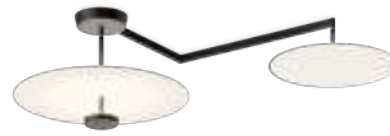

106 x 90 cm

**5910**



178 x 149 cm

**5922**



186 x 149 cm

**5924**

5905

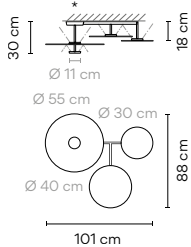

Finishes

- 10/ \_\_ White (NCS S 0300-N)
- 71/ \_\_ White, Green L1, Off-white (NCS S 0300-N, NCS S 4005-G80Y, NCS S 1000-N)

LED temperature colour

- /1 \_ 2700 K E CRI >90 5906,88 lm 109 lm/W
- /3 \_ 3500 K F CRI >90 6344,4 lm 117,5 lm/W

Control

5905 \_\_ / \_\_ A  
 DALI-2, 1-10V, Push

1.610,00 €

Materials

Shade: Aluminum. Diffuser: Polycarbonate.  
 Structures: Steel. Canopy: Aluminum.

Light Source and electronics

4 x LED PLATE 13,5 W 700 mA  
 Constant Current 700 mA  
 110-240V 50/60Hz

Packaging

1 Box 0,75 x 0,45 x 0,25 m  
 Vol 0,0844 m<sup>3</sup>  
 Gross weight 17,15 Kg Net weight 15,38 Kg

Notes

\* Electrical connection point



5910

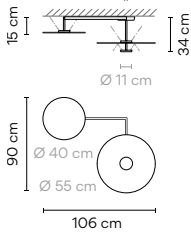

Finishes

- 10/ \_\_ White (NCS S 0300-N)
- 72/ \_\_ White, Green L1 (NCS S 0300-N, NCS S 4005-G80Y)
- 73/ \_\_ White, Grey L1 (S 0300-N, NCS S 1000-N)

LED temperature colour

- /1 \_ 2700 K E CRI >90 4430,16 lm 109 lm/W
- /3 \_ 3500 K F CRI >90 4758,3 lm 117,5 lm/W

Control

5910 \_\_ / \_\_ A  
 DALI-2, 1-10V, Push

1.220,00 €

Materials

Shade: Aluminum. Diffuser: Polycarbonate.  
 Structures: Steel. Canopy: Aluminum.

Light Source and electronics

3 x LED PLATE 13,5 W 700 mA  
 Constant Current 700 mA  
 110-240V 50/60Hz

Packaging

1 Box 0,80 x 0,70 x 0,30 m  
 Vol 0,1680 m<sup>3</sup>  
 Gross weight 11,90 Kg Net weight 9,10 Kg

Notes

\* Electrical connection point



5915

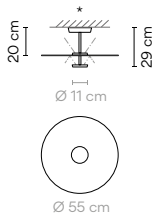

Finishes

- 10/ \_\_ White (NCS S 0300-N)

LED temperature colour

- /1 \_ 2700 K E CRI >90 2953,44 lm 109 lm/W
- /3 \_ 3500 K F CRI >90 3172,2 lm 117,5 lm/W

Control

5915 \_\_ / \_\_ A  
 DALI-2, 1-10V, Push

850,00 €

Materials

Shade: Aluminum. Diffuser: Polycarbonate.  
 Structures: Steel. Canopy: Aluminum.

Light Source and electronics

2 x LED PLATE 13,5 W 700 mA  
 Constant Current 700 mA  
 110-240V 50/60Hz

Packaging

1 Box 0,65 x 0,65 x 0,25 m  
 Vol 0,0106 m<sup>3</sup>  
 Gross weight 6,80 Kg Net weight 4,73 Kg



Notes

\* Electrical connection point



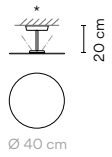



**5920**



|  |  |   |
|--|--|---|
| <b>Finishes</b>  | <b>LED temperature colour</b>  | <b>Control</b>  |
| <ul style="list-style-type: none"> <li>● <b>10/</b> __ White (NCS S 0300-N)</li> <li>● <b>13/</b> __ Off-White (NCS S 1000-N)</li> <li>● <b>47/</b> __ Green L1 (NCS S 4005-G80Y)</li> </ul> | <ul style="list-style-type: none"> <li><b>/1</b> _ 2700 K  CRI &gt;90 1740 lm 129 lm/W</li> <li><b>/3</b> _ 3500 K  CRI &gt;90 1868,9 lm 138,4 lm/W</li> </ul> | <ul style="list-style-type: none"> <li><b>5920</b> __ / _ <b>1</b> DALI-2 <b>605,00 €</b></li> <li><b>5920</b> __ / _ <b>B</b> 1-10V, Push <b>575,00 €</b></li> </ul> |



---

|   |  |
|---|--|
| <b>Materials</b>  | <b>Packaging</b>   |
| Shade: Aluminum. Diffuser: Polycarbonate.<br>Structures: Steel. Canopy: Aluminum. | 1 Box 0,45 x 0,45 x 0,25 m<br>Vol 0,0051 m <sup>3</sup><br>Gross weight 3,10 Kg Net weight 1,91 Kg |
| <b>Light Source and electronics</b>   | <b>Notes</b>   |
| 1 x LED PLATE 13,5 W 700 mA<br>Constant Current 700 mA<br>110-240V 50/60Hz        | * Electrical connection point  |



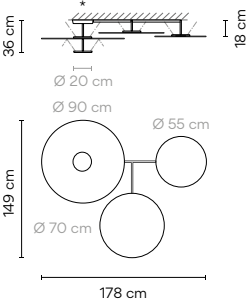

**5922**



|  |  |  |
|--|--|--|
| <b>Finishes</b>  | <b>LED temperature colour</b>  | <b>Control</b>   |
| <ul style="list-style-type: none"> <li>● <b>10/</b> __ White (NCS S 0300-N)</li> <li>● <b>71/</b> __ White, Green L1, Off-white (NCS S 0300-N, NCS S 4005-G80Y, NCS S 1000-N)</li> </ul> | <ul style="list-style-type: none"> <li><b>/1</b> _ 2700 K  CRI &gt;90 13920 lm 139 lm/W</li> <li><b>/3</b> _ 3500 K  CRI &gt;90 14951,1 lm 149,5 lm/W</li> </ul> | <ul style="list-style-type: none"> <li><b>5922</b> __ / _ <b>A</b> DALI-2, 1-10V, Push <b>2.465,00 €</b></li> <li><b>5922</b> __ / _ <b>Z</b> Casambi <b>2.585,00 €</b></li> </ul> |



---

|   |  |
|---|--|
| <b>Materials</b>  | <b>Packaging</b>   |
| Shade: Aluminum. Diffuser: Polycarbonate.<br>Structures: Steel. Canopy: Aluminum. | 1 Box 1,35 x 1,20 x 0,30 m<br>Vol 0,0486 m <sup>3</sup><br>Gross weight 26,60 Kg Net weight 19,98 Kg |
| <b>Light Source and electronics</b>   | <b>Notes</b>   |
| 4 x LED PLATE 25 W 700mA<br>Constant Current 700 mA<br>220-240V 50/60Hz           | * Electrical connection point  |



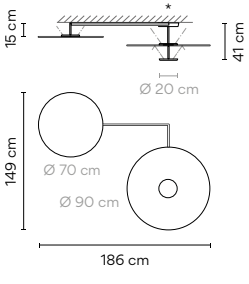

**5924**



|  |  |  |
|--|--|--|
| <b>Finishes</b>  | <b>LED temperature colour</b>  | <b>Control</b>   |
| <ul style="list-style-type: none"> <li>● <b>10/</b> __ White (NCS S 0300-N)</li> <li>● <b>72/</b> __ White, Green L1 (NCS S 0300-N, NCS S 4005-G80Y)</li> <li>● <b>73/</b> __ White, Grey L1 (S 0300-N, NCS S 1000-N)</li> </ul> | <ul style="list-style-type: none"> <li><b>/1</b> _ 2700 K  CRI &gt;90 9897,27 lm 132 lm/W</li> <li><b>/3</b> _ 3500 K  CRI &gt;90 10630,4 lm 141,7 lm/W</li> </ul> | <ul style="list-style-type: none"> <li><b>5924</b> __ / _ <b>A</b> DALI-2, 1-10V, Push <b>2.125,00 €</b></li> <li><b>5924</b> __ / _ <b>Z</b> Casambi <b>2.245,00 €</b></li> </ul> |

---

|   |   |
|---|---|
| <b>Materials</b>  | <b>Packaging</b>  |
| Shade: Aluminum. Diffuser: Polycarbonate.<br>Structures: Steel. Canopy: Aluminum. | 1 Box 1,45 x 1,10 x 0,25 m<br>Vol 0,0399 m <sup>3</sup><br>Gross weight 27 Kg Net weight 20,80 Kg |
| <b>Light Source and electronics</b>   | <b>Notes</b>  |
| 3 x LED PLATE 25 W 700mA<br>Constant Current 700 mA<br>110-240V 50/60Hz           | * Electrical connection point   |

5926

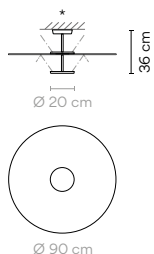

Finishes  
 ● 10/ \_ \_ White  
 (NCS S 0300-N)

LED temperature colour  
 /1 \_ 2700 K **D**  
 CRI >90 6598,18 lm 132 lm/W  
 /3 \_ 3500 K **E**  
 CRI >90 7086,9 lm 141,7 lm/W

Control  
 5926 \_ \_ / \_ A 1.205,00 €  
 DALI-2, 1-10V, Push

Materials  
 Shade: Aluminum. Diffuser: Polycarbonate.  
 Structures: Steel. Canopy: Aluminum.

Light Source and electronics  
 2 x LED PLATE 25 W 700 mA  
 Constant Current 700 mA  
 110~240V 50/60Hz

Packaging  
 1 Box 1,05 x 1,05 x 0,25 m  
 Vol 0,0276 m<sup>3</sup>  
 Gross weight 14,60 Kg Net weight 10,08 Kg

Notes  
 \* Electrical connection point



Pendants

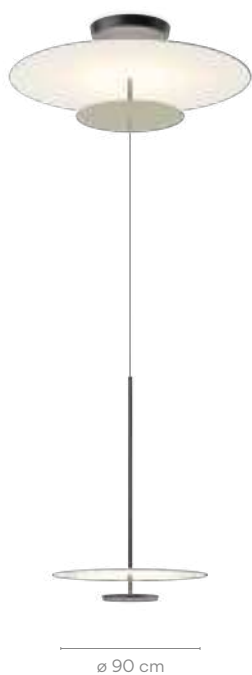

5930



5935



5940

5930

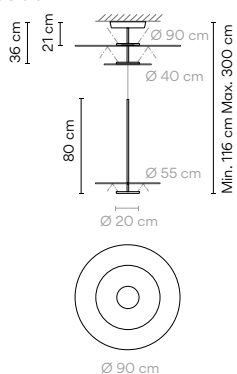

|   |   |   |                              |                   |       |  |                              |                   |       |  |         |  |
|---|---|---|------------------------------|-------------------|-------|--|------------------------------|-------------------|-------|--|---------|--|
| <p><b>Finishes</b></p> <ul style="list-style-type: none"> <li>● <b>13/</b> _ _ Off-White (NCS S 1000-N)</li> <li>● <b>37/</b> _ _ Terra Red (NCS S 4040-Y70R)</li> <li>● <b>47/</b> _ _ Green L1 (NCS S 4005-G80Y)</li> </ul> | <p><b>LED temperature colour</b></p> <ul style="list-style-type: none"> <li><b>/1</b> _ 2700 K  CRI &gt;90 9897,27 lm 132 lm/W</li> <li><b>/3</b> _ 3500 K  CRI &gt;90 10630,4 lm 141,7 lm/W</li> </ul> | <p><b>Control</b></p> <table border="0"> <tr> <td><b>5930</b> _ _ / _ <b>A</b></td> <td style="text-align: right;"><b>2.185,00 €</b></td> </tr> <tr> <td colspan="2"><hr/></td> </tr> <tr> <td><b>5930</b> _ _ / _ <b>Z</b></td> <td style="text-align: right;"><b>2.305,00 €</b></td> </tr> <tr> <td colspan="2"><hr/></td> </tr> <tr> <td colspan="2">Casambi</td> </tr> </table> | <b>5930</b> _ _ / _ <b>A</b> | <b>2.185,00 €</b> | <hr/> |  | <b>5930</b> _ _ / _ <b>Z</b> | <b>2.305,00 €</b> | <hr/> |  | Casambi |  |
| <b>5930</b> _ _ / _ <b>A</b>  | <b>2.185,00 €</b>   |   |                              |                   |       |  |                              |                   |       |  |         |  |
| <hr/>   |   |   |                              |                   |       |  |                              |                   |       |  |         |  |
| <b>5930</b> _ _ / _ <b>Z</b>  | <b>2.305,00 €</b>   |   |                              |                   |       |  |                              |                   |       |  |         |  |
| <hr/>   |   |   |                              |                   |       |  |                              |                   |       |  |         |  |
| Casambi   |   |   |                              |                   |       |  |                              |                   |       |  |         |  |
| <p><b>Materials</b><br/>Shade: Aluminum Diffuser: Polycarbonate.<br/>Structures: Steel. Canopy: Aluminum</p>  |   |   |                              |                   |       |  |                              |                   |       |  |         |  |
| <p><b>Light Source and electronics</b><br/>3 x LED PLATE 25 W 700mA<br/>Constant Current 700 mA<br/>220-240V 50/60Hz</p>  |   |   |                              |                   |       |  |                              |                   |       |  |         |  |
| <p><b>Packaging</b><br/>1 Box 0,96x0,96x0,50 m<br/>Vol 0,4608 m<sup>3</sup><br/>Gross weight 19 Kg Net weight 10,5 Kg</p>   |   |   |                              |                   |       |  |                              |                   |       |  |         |  |
| <p><b>Notes</b><br/>Adjust the height on installation</p>   |   |   |                              |                   |       |  |                              |                   |       |  |         |  |
| <p>LED  IP20   </p>   |   |   |                              |                   |       |  |                              |                   |       |  |         |  |



1160 10 /1A \_18

Model  
Finish  
LED temperature colour  
Control  
Electrical connection  
Only for pendants



5935

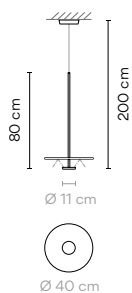

Finishes

- 13/ \_ \_ Off-White (NCS S 1000-N)
- 37/ \_ \_ Terra Red (NCS S 4040-Y70R)
- 47/ \_ \_ Green L1 (NCS S 4005-G80Y)

LED temperature colour

- /1 \_ 2700 K CRI >90 1740 lm 129 lm/W
- /3 \_ 3500 K CRI >90 1868,9 lm 138,4 lm/W

Control

- |                |          |
|----------------|----------|
| 5935 _ _ / _ 1 | 595,00 € |
| DALI           |          |
| 5935 _ _ / _ B | 565,00 € |
| 1-10V, Push    |          |

Materials

Shade: Aluminum Diffuser: Polycarbonate.  
Structures: Steel. Canopy: Aluminum

Light Source and electronics

1 x LED PLATE 13,5 W 700 mA  
Constant Current 700 mA  
110-240V 50/60Hz

Packaging

1 Box 0,45 x 0,80 x 0,20 m  
Vol 0,0072 m<sup>3</sup>  
Gross weight 6,10 Kg Net weight 5 Kg

Notes

Extra cable length. 16,00 €/m

Electrical connection  
Surface  
\_18 Free Wire  
\_23 Built-in  
\_31 Remote Micro for plaster ceilings  
\_32 Remote XXS for all types of drop ceilings

5940

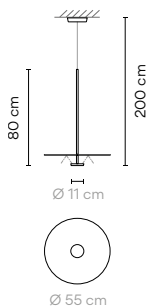

Finishes

- 13/ \_ \_ Off-White (NCS S 1000-N)
- 37/ \_ \_ Terra Red (NCS S 4040-Y70R)
- 47/ \_ \_ Green L1 (NCS S 4005-G80Y)

LED temperature colour

- /1 \_ 2700 K CRI >90 1740 lm 129 lm/W
- /3 \_ 3500 K CRI >90 1868,9 lm 138,4 lm/W

Control

- |                |          |
|----------------|----------|
| 5940 _ _ / _ 1 | 720,00 € |
| DALI           |          |
| 5940 _ _ / _ B | 685,00 € |
| 1-10V, Push    |          |

Materials

Shade: Aluminum Diffuser: Polycarbonate.  
Structures: Steel. Canopy: Aluminum

Light Source and electronics

1 x LED PLATE 13,5 W 700 mA  
Constant Current 700 mA  
110-240V 50/60Hz

Packaging

1 Box 0,65 x 0,85 x 0,20 m  
Vol 0,0111 m<sup>3</sup>  
Gross weight 7 Kg Net weight 6 Kg

Notes

Extra cable length. 16,00 €/m

# Composing pendants

Next sketches are composed by one or more compositions

---

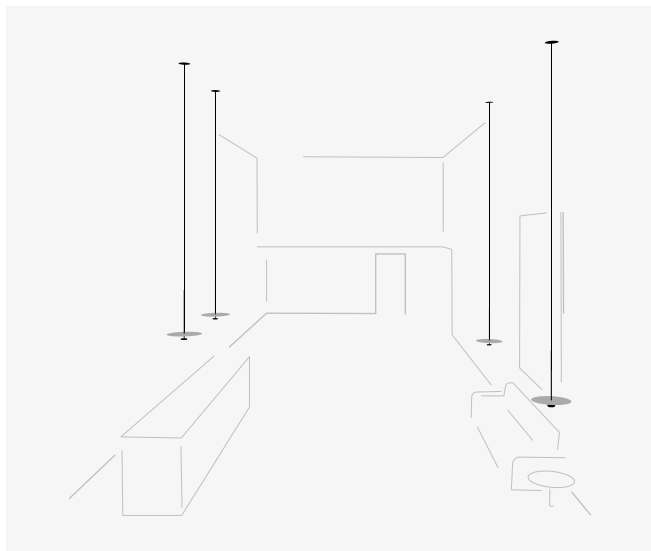

4 x 5935.

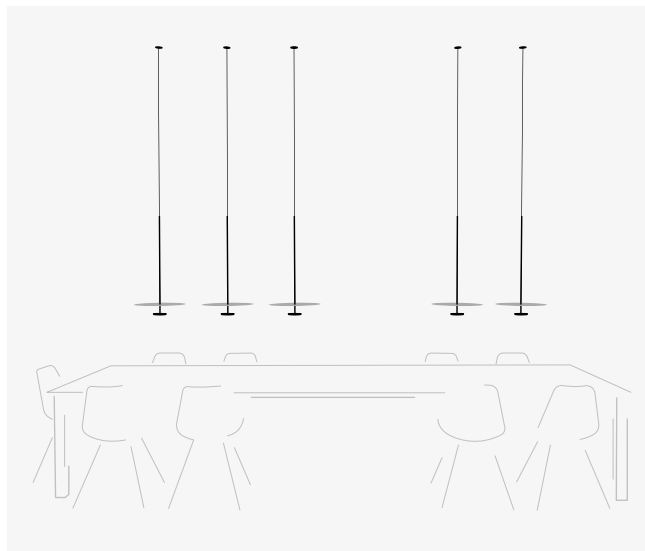

5 x 5935.

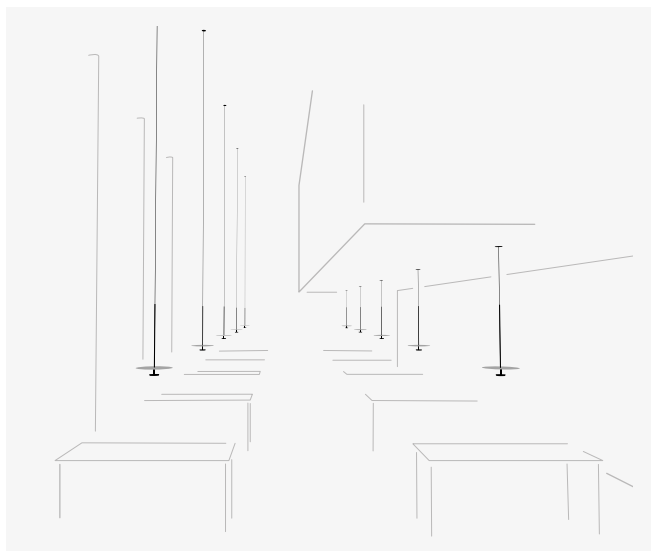

10 x 5935..

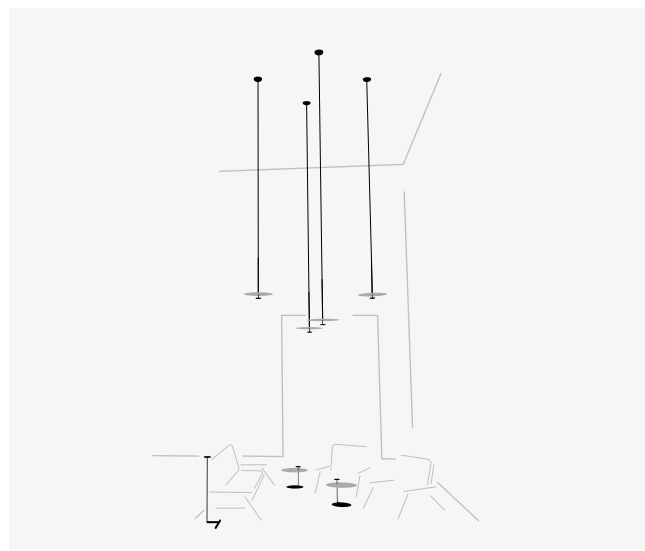

4 x 5935.

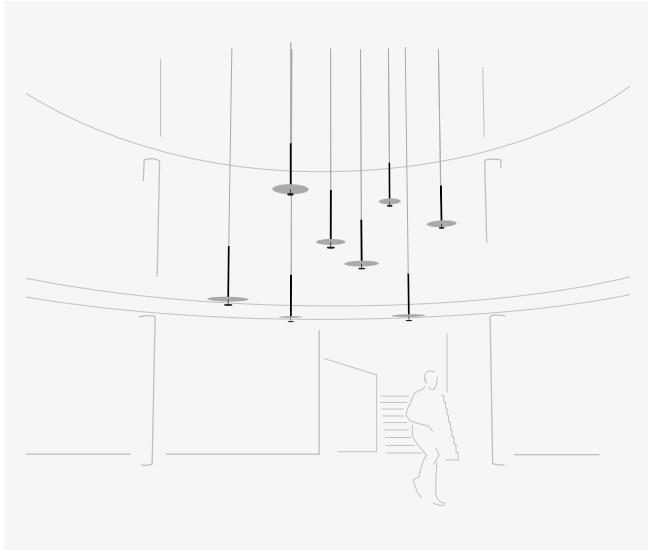

8 x 5935.

Each project is unique.  
Visit [vibia.com](http://vibia.com) and  
choose among multiple  
compositions designed  
and adapted to your  
project needs.

Personalise your own  
Flat composition quick  
and easy at [vibia.com](http://vibia.com)

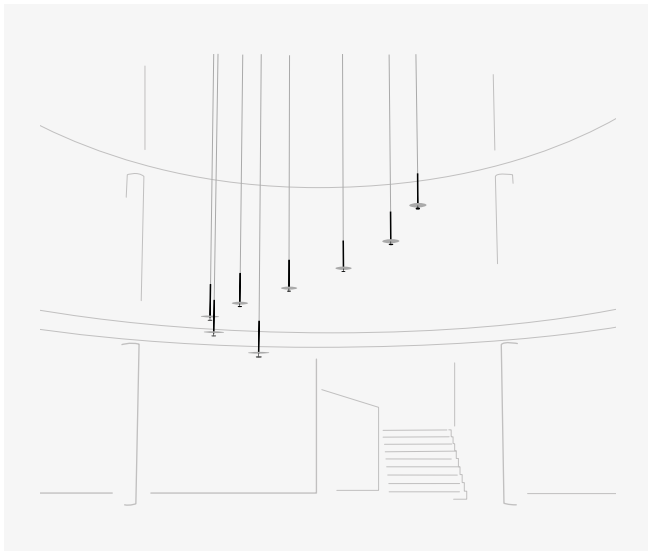

8 x 5935.

# Electrical connection options for model 5935

Choose your preferred installation option according to your needs. For each composition, the optimal minimum number of drivers will be delivered.

## Drop ceiling

The innovative remote and built-in fittings accentuate the silkiness and lightness of compositions on suspended ceilings, its great visual grandeur taking center stage.

For Ref. 5935

### Remote

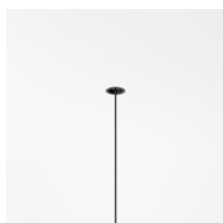

**Micro**  $\varnothing$  3 cm  
height 7 cm  
for plaster ceilings.  
Black finish.

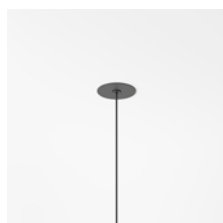
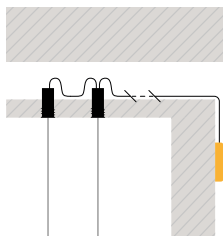

**XXS**  $\varnothing$  6 cm  
height 6 cm  
for all types of drop ceilings. Match with fixture finish.

### Built-in



$\varnothing$  8 cm  
height 6 cm  
match with fixture finish.

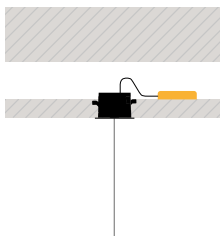

---

## Regular ceiling

When architecture does not allow for performance, surface and free wire showcase possibilities for any need or desire with no limits, ideal for both individual or cluster arrangements.

For Ref. 5935

### Surface



ø 16,7 cm  
match with  
fixture finish.

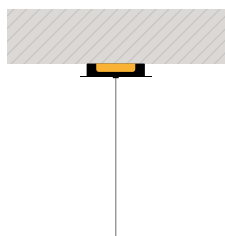

### Free Wire



1 wire

ø 20 cm

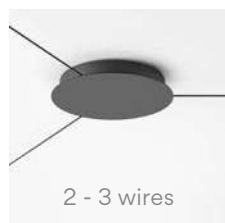

2 - 3 wires

ø 22 cm



4 - 6 wires

ø 36 cm



7 - 9 wires

ø 40 cm

you can choose the finish of the canopy  
among black, white or any colour  
matching one of the pendants.

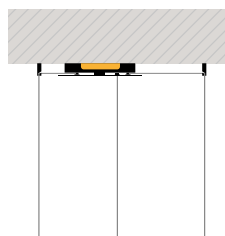

Floor



5945



5950

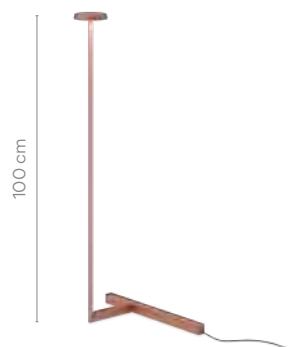

5955



5957

5945

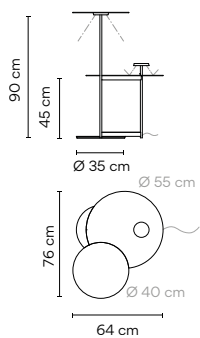

|   |  |  |                   |
|---|--|--|-------------------|
| <p><b>Finishes</b></p> <ul style="list-style-type: none"> <li>● 13/ _ _ Off-White (NCS S 1000-N)</li> <li>● 47/ _ _ Green L1 (NCS S 4005-G80Y)</li> </ul> | <p><b>LED temperature colour</b></p> <ul style="list-style-type: none"> <li>/1_ 2700 K  CRI &gt;90 1365,8 lm 98 lm/W</li> <li>/3_ 3500 K  CRI &gt;90 1467,0 lm 104,8 lm/W</li> </ul> | <p><b>Control</b></p> <p>5945 _ _ / _ 5<br/>Push</p> | <p>1.695,00 €</p> |
|---|--|--|-------------------|

|   |  |
|---|--|
| <p><b>Materials</b></p> <p>Shade: Aluminum.<br/>Diffuser: Polycarbonate. Structures: Steel.</p> <p><b>Light Source and electronics</b></p> <p>2 x LED PLATE 7 W 400 mA<br/>Driver Constant Voltage 24V<br/>110-240V 50/60Hz</p> | <p><b>Packaging</b></p> <p>1 Box 0,65 x 1,00 x 0,25 m<br/>Vol 0,0163 m<sup>3</sup><br/>Gross weight 15,85 Kg Net weight 15,25 Kg</p> <p><b>Notes</b></p> <p>Electric cable 2 m</p> |
|---|--|

LED  IP20 Dimmer  Bi-volt

5950

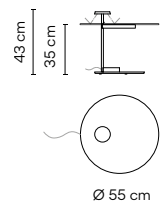

|   |  |  |                   |
|---|--|--|-------------------|
| <p><b>Finishes</b></p> <ul style="list-style-type: none"> <li>● 10/ _ _ White (NCS S 0300-N)</li> </ul> | <p><b>LED temperature colour</b></p> <ul style="list-style-type: none"> <li>/1_ 2700 K  CRI &gt;90 682,9 lm 98 lm/W</li> <li>/3_ 3500 K  CRI &gt;90 733,5 lm 104,8 lm/W</li> </ul> | <p><b>Control</b></p> <p>5950 _ _ / _ 5<br/>Push</p> | <p>1.100,00 €</p> |
|---|--|--|-------------------|

|   |  |
|---|--|
| <p><b>Materials</b></p> <p>Shade: Aluminum.<br/>Diffuser: Polycarbonate. Structures: Steel.</p> <p><b>Light Source and electronics</b></p> <p>1 x LED PLATE 7 W 400 mA<br/>Driver Constant Voltage 24V<br/>110-240V 50/60Hz</p> | <p><b>Packaging</b></p> <p>1 Box 0,65 x 0,65 x 0,20 m<br/>Vol 0,0085 m<sup>3</sup><br/>Gross weight 14,60 Kg Net weight 12,71 Kg</p> <p><b>Notes</b></p> <p>Electric cable 2 m</p> |
|---|--|

LED  IP20 Dimmer  Bi-volt



### 5955

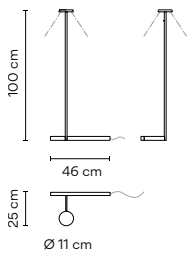

#### Finishes

- **11/** \_ \_ Black (NCS S 8500-N)
- **37/** \_ \_ Terra Red (NCS S 4040-Y70R)
- **47/** \_ \_ Green L1 (NCS S 4005-G80Y)

#### LED temperature colour

- /1 \_ 2700 K CRI >90 682,9 lm 98 lm/W
- /3 \_ 3500 K CRI >90 733,5 lm 104,8 lm/W

#### Control

**5955** \_ \_ / \_ 5  
 Push

**725,00 €**

#### Materials

Shade: Aluminum.  
 Diffuser: Polycarbonate. Structures: Steel.

#### Light Source and electronics

1 x LED PLATE 7 W 400 mA  
 Driver Constant Voltage 24V  
 110-240V 50/60Hz

#### Packaging

1 Box 0,30 x 1,10 x 0,10 m  
 Vol 0,0033 m<sup>3</sup>  
 Gross weight 4,80 Kg Net weight 3,50 Kg

#### Notes

Electric cable 2 m

### 5957

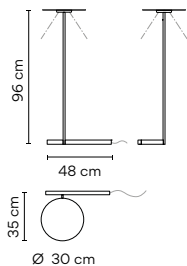

#### Finishes

- **37/** \_ \_ Terra Red (NCS S 4040-Y70R)
- **47/** \_ \_ Green L1 (NCS S 4005-G80Y)

#### LED temperature colour

- /1 \_ 2700 K CRI >90 682,9 lm 98 lm/W
- /3 \_ 3500 K CRI >90 733,5 lm 104,8 lm/W

#### Control

**5957** \_ \_ / \_ 5  
 Push

**770,00 €**

#### Materials

Shade: Aluminum.  
 Diffuser: Polycarbonate. Structures: Steel.

#### Light Source and electronics

1 x LED PLATE 7 W 400 mA  
 Constant Voltage 24V  
 110-240V 50/60Hz

#### Packaging

1 Box 0,40 x 1,10 x 0,10 m  
 Vol 0,0044 m<sup>3</sup>  
 Gross weight 6,10 Kg Net weight 4,46 Kg

#### Notes

Electric cable 2 m

Table



**5965**

|  |   |   |  |                                    |
|--|---|---|--|------------------------------------|
|  | <b>Finishes</b><br><ul style="list-style-type: none"> <li>● 13/ _ _ Off-White (NCS S 1000-N)</li> <li>● 47/ _ _ Green L1 (NCS S 4005-G80Y)</li> </ul> | <b>LED temperature colour</b><br>/1_ 2700 K<br>CRI >90 682,9 lm 98 lm/W                                   | <b>Control</b><br>5965 _ _ / _ 5<br>Push   | <b>620,00 €</b>                    |
|  | <b>Materials</b><br>Shade: Aluminum.<br>Diffuser: Polycarbonate. Structures: Steel.   | <b>Light Source and electronics</b><br>1 x LED PLATE 7W 400mA<br>Constant Voltage 24V<br>110-240V 50/60Hz | <b>Packaging</b><br>1 Box 0,50 x 0,50 x 0,7 m<br>Vol 0,0018 m <sup>3</sup><br>Gross weight 4 Kg Net weight 3,11 Kg | <b>Notes</b><br>Electric cable 2 m |

**5970**

|  |  |   |   |                                    |
|--|--|---|---|------------------------------------|
|  | <b>Finishes</b><br><ul style="list-style-type: none"> <li>● 11/ _ _ Black (NCS S 8500-N)</li> <li>● 37/ _ _ Terra Red (NCS S 4040-Y70R)</li> <li>● 47/ _ _ Green L1 (NCS S 4005-G80Y)</li> </ul> | <b>LED temperature colour</b><br>/1_ 2700 K<br>CRI >90 682,9 lm 98 lm/W                                   | <b>Control</b><br>5970 _ _ / _ 5<br>Push  | <b>510,00 €</b>                    |
|  | <b>Materials</b><br>Shade: Aluminum.<br>Diffuser: Polycarbonate. Structures: Steel.  | <b>Light Source and electronics</b><br>1 x LED PLATE 7W 400mA<br>Constant Voltage 24V<br>110-240V 50/60Hz | <b>Packaging</b><br>1 Box 0,20 x 0,40 x 0,07 m<br>Vol 0,0072 m <sup>3</sup><br>Gross weight 4 Kg Net weight 3,11 Kg | <b>Notes</b><br>Electric cable 2 m |





# Spa

Design by Ramos & Bassols

Spa is the perfect lighting solution for any wellness space. From public dressing rooms, restaurants and spas, to private kitchens, corridors and bathrooms, its graceful simplicity allows for easy cleaning and seamless integration within the surrounding architecture of a variety of interiors.

## Ceiling Wall



5975



121 cm

5977



201 cm

5979



301 cm

5981



253 cm

5983

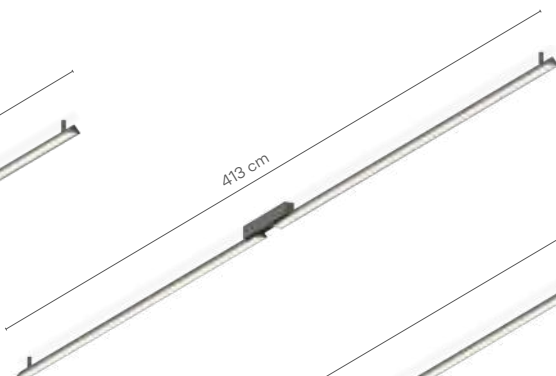

413 cm

5985

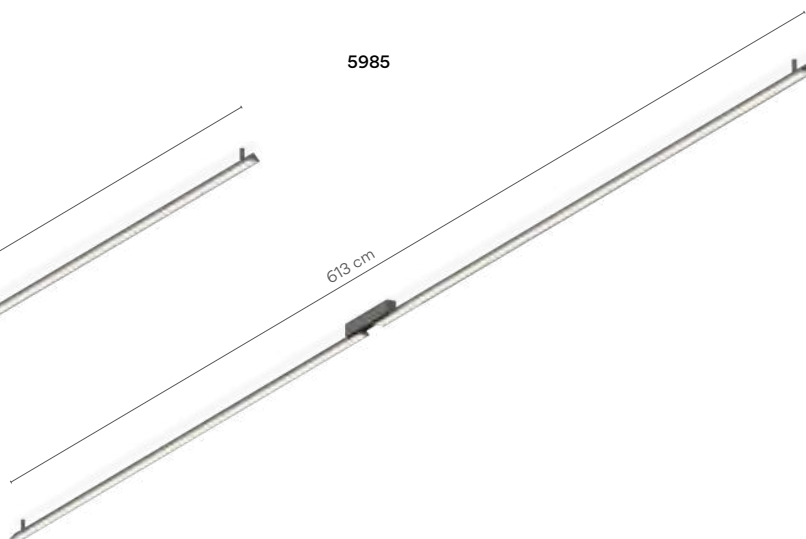

613 cm



## 5975

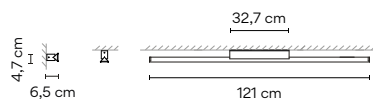

| Finishes                                 | LED temperature colour               |
|--|--------------------------------------|
| ● 11/ __ Black<br>(NCS S 8500-N)         | /1_ 2700 K  CRI >90 1560 lm 144 lm/W |
| ● 23/ __ Warm White<br>(NCS S 0502-Y50R) | /3_ 3500 K  CRI >90 1290 lm 178 lm/W |
| ● 25/ __ Beige D1<br>(NCS S 4005-Y50R)   |                                      |

| Control                               |          |
|---------------------------------------|----------|
| 5975 __ / _ 1<br>DALI                 | 720,00 € |
| 5975 __ / _ 3<br>1-10V                | 685,00 € |
| 5975 __ / _ Z_ 30<br>Casambi (Remote) | 805,00 € |

### Materials

Profile: Aluminum. Difuser: PMMA & Silicone.  
Canopy: Aluminum.

### Light Source and electronics

1 x LED STRIP 10,8 W 600 mA  
Constant Current 600 mA  
220~240V 50/60Hz

### Packaging

1 Box 1,5 x 0,1 x 0,1 m  
Vol 0,015 m<sup>3</sup>  
Gross weight 3,1 Kg Net weight 1,6 Kg

## 5977

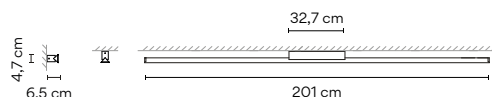

| Finishes                                 | LED temperature colour               |
|--|--------------------------------------|
| ● 11/ __ Black<br>(NCS S 8500-N)         | /1_ 2700 K  CRI >90 2560 lm 119 lm/W |
| ● 23/ __ Warm White<br>(NCS S 0502-Y50R) | /3_ 3500 K  CRI >90 3360 lm 156 lm/W |
| ● 25/ __ Beige D1<br>(NCS S 4005-Y50R)   |                                      |

| Control                               |          |
|---------------------------------------|----------|
| 5977 __ / _ 1<br>DALI                 | 880,00 € |
| 5977 __ / _ 3<br>1-10V                | 835,00 € |
| 5977 __ / _ Z_ 30<br>Casambi (Remote) | 955,00 € |

### Materials

Profile: Aluminum. Difuser: PMMA & Silicone.  
Canopy: Aluminum.

### Light Source and electronics

1 x LED STRIP 21,6 W 600 mA  
Constant Current 600 mA  
220~240V 50/60Hz

### Packaging

1 Box 2,3 x 0,1 x 0,1 m  
Vol 0,023 m<sup>3</sup>  
Gross weight 4,9 Kg Net weight 2,6

## 5979

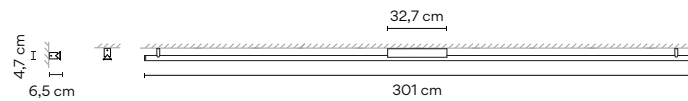

| Finishes  | LED temperature colour                 | Control                                      |                   |
|---|--|--|-------------------|
| ● <b>11/</b> __ Black<br>(NCS S 8500-N)         | /1_ 2700 K<br>CRI >90 3840 lm 119 lm/W | <b>5979</b> __ / _ 1<br>DALI                 | <b>1.115,00 €</b> |
| ● <b>23/</b> __ Warm White<br>(NCS S 0502-Y50R) | /3_ 3500 K<br>CRI >90 5040 lm 156 lm/W | <b>5979</b> __ / _ 3<br>1-10V                | <b>1.060,00 €</b> |
| ● <b>25/</b> __ Beige D1<br>(NCS S 4005-Y50R)   |  | <b>5979</b> __ / _ Z_ 30<br>Casambi (Remote) | <b>1.180,00 €</b> |

## Materials

Profile: Aluminum. Difuser: PMMA & Silicone.  
Canopy: Aluminum.

## Light Source and electronics

1 x LED STRIP 32,4 W 600 mA  
Constant Current 600 mA  
220~240V 50/60Hz

## Packaging

1 Box 3,3 x 0,1 x 0,1 m  
Vol 0,033 m<sup>3</sup>  
Gross weight 6,9 Kg Net weight 3,6 Kg

## 5981

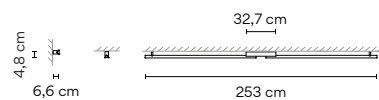

| Finishes  | LED temperature colour                 | Control                                      |                   |
|---|--|--|-------------------|
| ● <b>11/</b> __ Black<br>(NCS S 8500-N)         | /1_ 2700 K<br>CRI >90 3120 lm 144 lm/W | <b>5981</b> __ / _ 1<br>DALI                 | <b>1.080,00 €</b> |
| ● <b>23/</b> __ Warm White<br>(NCS S 0502-Y50R) | /3_ 3500 K<br>CRI >90 3840 lm 178 lm/W | <b>5981</b> __ / _ 3<br>1-10V                | <b>1.025,00 €</b> |
| ● <b>25/</b> __ Beige D1<br>(NCS S 4005-Y50R)   |  | <b>5981</b> __ / _ Z_ 30<br>Casambi (Remote) | <b>1.145,00 €</b> |

## Materials

Profile: Aluminum. Difuser: PMMA & Silicone.  
Canopy: Aluminum.

## Light Source and electronics

2 x LED STRIP 10,8 W 600 mA  
Constant Current 600 mA  
220~240V 50/60Hz

## Packaging

2 Boxes  
Total Vol 0,030 m<sup>3</sup>  
Gross weight 5,8 Kg Net weight 2,8 Kg

## 5983

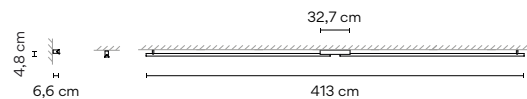

| Finishes  | LED temperature colour                 | Control                                      |                   |
|---|--|--|-------------------|
| ● <b>11/</b> __ Black<br>(NCS S 8500-N)         | /1_ 2700 K<br>CRI >90 5120 lm 119 lm/W | <b>5983</b> __ / _ 1<br>DALI                 | <b>1.425,00 €</b> |
| ● <b>23/</b> __ Warm White<br>(NCS S 0502-Y50R) | /3_ 3500 K<br>CRI >90 6720 lm 156 lm/W | <b>5983</b> __ / _ 3<br>1-10V                | <b>1.355,00 €</b> |
| ● <b>25/</b> __ Beige D1<br>(NCS S 4005-Y50R)   |  | <b>5983</b> __ / _ Z_ 30<br>Casambi (Remote) | <b>1.475,00 €</b> |

## Materials

Profile: Aluminum. Difuser: PMMA & Silicone.  
Canopy: Aluminum.

## Light Source and electronics

2 x LED STRIP 21,6 W 600 mA  
Constant Current 1200 mA  
220~240V 50/60Hz

## Packaging

2 Boxes  
Total Vol 0,046 m<sup>3</sup>  
Gross weight 9,4 Kg Net weight 4,8 Kg

5985

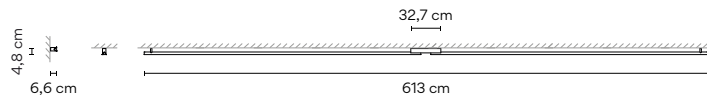

| Finishes                                 | LED temperature colour                   | Control                           |            |
|--|--|-----------------------------------|------------|
| ● 11/ __ Black<br>(NCS S 8500-N)         | /1 _ 2700 K<br>CRI >90 7680 lm 119 lm/W  | 5985 __ / _ 1<br>DALI (Remote)    | 1.840,00 € |
| ● 23/ __ Warm White<br>(NCS S 0502-Y50R) | /3 _ 3500 K<br>CRI >90 10080 lm 156 lm/W | 5985 __ / _ 3<br>1-10V (Remote)   | 1.750,00 € |
| ● 25/ __ Beige D1<br>(NCS S 4005-Y50R)   |  | 5985 __ / _ Z<br>Casambi (Remote) | 1.870,00 € |

Materials

Profile: Aluminum. Difuser: PMMA & Silicone.  
 Canopy: Aluminum.

Light Source and electronics

2 x LED STRIP 32,4 W 600 mA  
 Constant Current 600 mA Remote  
 220-240V 50/60Hz

Packaging

2 Boxes  
 Total Vol 0,066 m<sup>3</sup>  
 Gross weight 13,5 Kg Net weight 6,9 Kg



Wall Vanity light

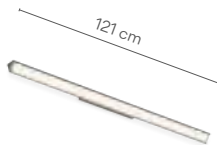

5987

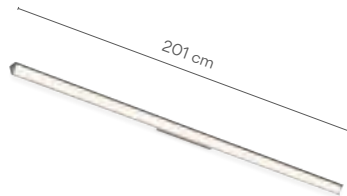

5989

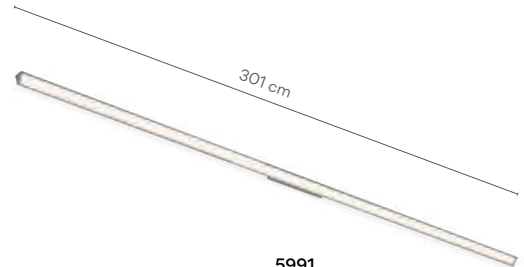

5991



## 5987

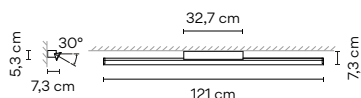

| Finishes  | LED temperature colour | Control                                  |                 |
|---|------------------------|--|-----------------|
| ● <b>11/</b> __ Black<br>(NCS S 8500-N)         | /1 _ 2700 K            | <b>5987</b> __ / _ 1<br>DALI             | <b>745,00 €</b> |
| ● <b>23/</b> __ Warm White<br>(NCS S 0502-Y50R) | /3 _ 3500 K            | <b>5985</b> __ / _ 3<br>1-10V            | <b>705,00 €</b> |
| ● <b>25/</b> __ Beige D1<br>(NCS S 4005-Y50R)   | /3 _ 3500 K            | <b>5985</b> __ / _ Z<br>Casambi (Remote) | <b>825,00 €</b> |

## Materials

Profile: Aluminum. Difuser: PMMA & Silicone.  
Canopy: Aluminum.

## Light Source and electronics

1 x LED STRIP 10,8 W 600 mA  
Constant Current 600 mA  
220-240V 50/60Hz

## Packaging

1 Box 1,5 x 0,1 x 0,1 m  
Vol 0,015 m<sup>3</sup>  
Gross weight 3,1 Kg Net weight 1,6 Kg

## Notes

Central canopy with module  
LED inclined 30°

## 5989

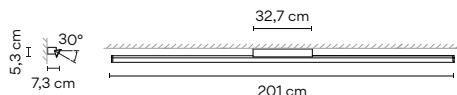

| Finishes  | LED temperature colour | Control                                  |                 |
|---|------------------------|--|-----------------|
| ● <b>11/</b> __ Black<br>(NCS S 8500-N)         | /1 _ 2700 K            | <b>5989</b> __ / _ 1<br>DALI             | <b>895,00 €</b> |
| ● <b>23/</b> __ Warm White<br>(NCS S 0502-Y50R) | /3 _ 3500 K            | <b>5989</b> __ / _ 3<br>1-10V            | <b>850,00 €</b> |
| ● <b>25/</b> __ Beige D1<br>(NCS S 4005-Y50R)   | /3 _ 3500 K            | <b>5989</b> __ / _ Z<br>Casambi (Remote) | <b>970,00 €</b> |

## Materials

Profile: Aluminum. Difuser: PMMA & Silicone.  
Canopy: Aluminum.

## Light Source and electronics

1 x LED STRIP 21,6 W 600 mA  
Constant Current 600 mA  
220-240V 50/60Hz

## Packaging

1 Box 2,3 x 0,1 x 0,1 m  
Vol 0,023 m<sup>3</sup>  
Gross weight 4,9 Kg Net weight 2,6 Kg

## Notes

Central canopy with module  
LED inclined 30°

## 5991

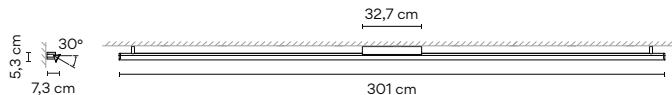

| Finishes  | LED temperature colour | Control                                  |                   |
|---|------------------------|--|-------------------|
| ● <b>11/</b> __ Black<br>(NCS S 8500-N)         | /1 _ 2700 K            | <b>5991</b> __ / _ 1<br>DALI             | <b>1.130,00 €</b> |
| ● <b>23/</b> __ Warm White<br>(NCS S 0502-Y50R) | /3 _ 3500 K            | <b>5991</b> __ / _ 3<br>1-10V            | <b>1.075,00 €</b> |
| ● <b>25/</b> __ Beige D1<br>(NCS S 4005-Y50R)   | /3 _ 3500 K            | <b>5991</b> __ / _ Z<br>Casambi (Remote) | <b>1.195,00 €</b> |

## Materials

Profile: Aluminum. Difuser: PMMA & Silicone.  
Canopy: Aluminum.

## Light Source and electronics

1 x LED STRIP 32,4 W 600 mA  
Constant Current 600 mA  
220-240V 50/60Hz

## Packaging

1 Box 3,3 x 0,1 x 0,1 m  
Vol 0,033 m<sup>3</sup>  
Gross weight 6,9 Kg Net weight 3,6 Kg

## Notes

Central canopy with module  
LED inclined 30°

## Vertical Wall

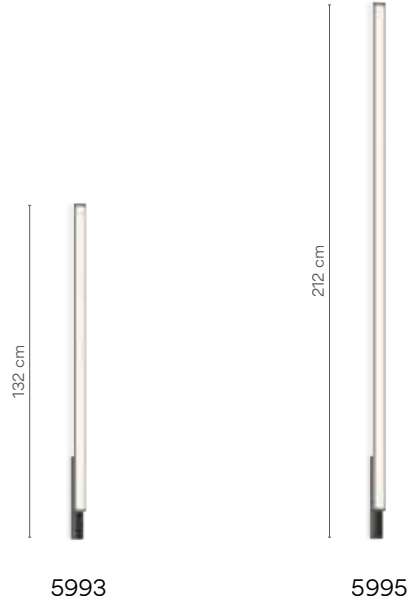

### 5993

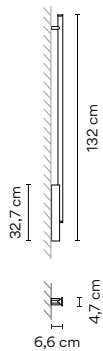

#### Finishes

- 11/ \_\_ Black (NCS S 8500-N)
- 23/ \_\_ Warm White (NCS S 0502-Y50R)
- 25/ \_\_ Beige D1 (NCS S 4005-Y50R)

#### LED temperature colour

- /1 \_ 2700 K CRI >90 1560 lm 144 lm/W
- /3 \_ 3500 K CRI >90 1920 lm 178 lm/W

#### Control

|                                |          |
|--------------------------------|----------|
| 5993 __ / _ 1 DALI             | 705,00 € |
| 5993 __ / _ 3 1-10V            | 670,00 € |
| 5993 __ / _ Z Casambi (Remote) | 790,00 € |

#### Materials

Profile: Aluminum. Difuser: PMMA & Silicone.  
 Canopy: Aluminum.

#### Light Source and electronics

1 x LED STRIP 10,8W 600 mA  
 Constant Current 600 mA  
 220~240V 50/60Hz

#### Packaging

1 Box 1,5 x 0,1 x 0,1 m  
 Vol 0,015 m<sup>3</sup>  
 Gross weight 3,1 Kg Net weight 1,6 Kg



### 5995

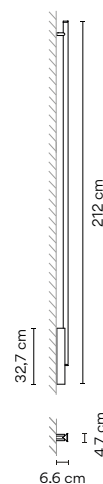

#### Finishes

- 11/ \_\_ Black (NCS S 8500-N)
- 23/ \_\_ Warm White (NCS S 0502-Y50R)
- 25/ \_\_ Beige D1 (NCS S 4005-Y50R)

#### LED temperature colour

- /1 \_ 2700 K CRI >90 2560 lm 119 lm/W
- /3 \_ 3500 K CRI >90 3360 lm 156 lm/W

#### Control

|                                |          |
|--------------------------------|----------|
| 5995 __ / _ 1 DALI             | 850,00 € |
| 5995 __ / _ 3 1-10V            | 805,00 € |
| 5995 __ / _ Z Casambi (Remote) | 925,00 € |

#### Materials

Profile: Aluminum. Difuser: PMMA & Silicone.  
 Canopy: Aluminum.

#### Light Source and electronics

1 x LED STRIP 21,6 W 600 mA  
 Constant Current 600 mA  
 220~240V 50/60Hz

#### Packaging

1 Box 2,3 x 0,1 x 0,1 m  
 Vol 0,023 m<sup>3</sup>  
 Gross weight 4,9 Kg Net weight 2,6 Kg



# Suite

Design by Jordi Vilardell & Meritxell Vidal

Reinterprets and updates the traditional combination of side table or shelf with table lamp. Its warm and comfortable lighting effect appears when least expected, a pleasant luminous surprise.

## Floor Table

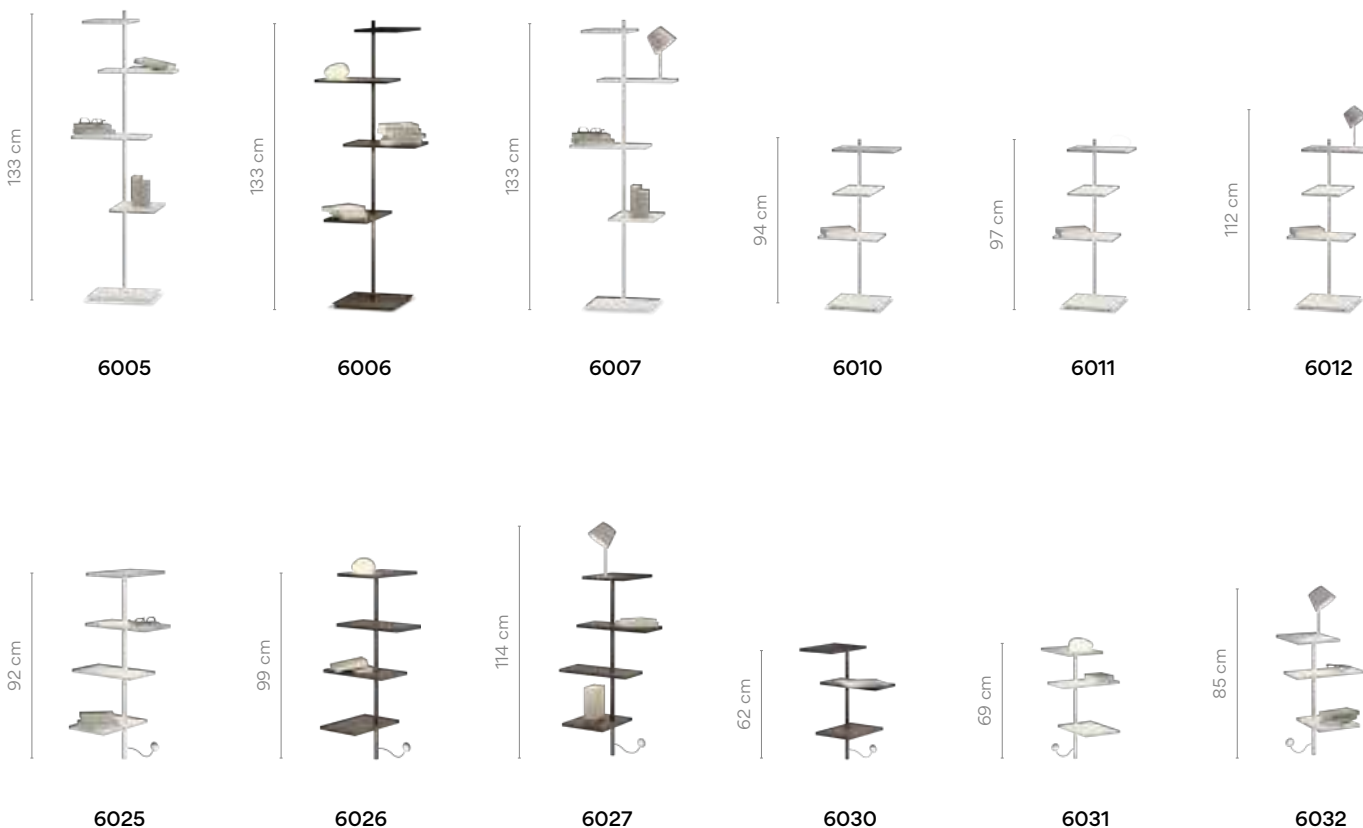

**6005**

**Finishes**

- **14/** \_\_ Chocolate (RAL 8019)
- **93/** \_\_ White (RAL 9016)

**Finish customization**  
(Available options: Vibia colour palette)

---

**Materials**  
Shelf: Aluminum. Diffuser: Polycarbonate.  
Vertical tube: Steel. Base: Steel. Lid: ABS with fiberglass.

**Light Source and electronics**  
8 x LED STRIP 24V 1,63 W  
Constant Voltage 24V  
220~240V 50Hz

**LED temperature colour**  
/1\_ 2700 K   
CRI >90 1054,6 lm 78 lm/W

**Control**  
**6005** \_\_ / \_\_ 0  
On/ Off

---

**Packaging**  
1 Box 0,730 x 0,535 x 1,385 m  
Vol 0,4513 m<sup>3</sup>  
Gross weight 34,1 Kg Net weight 16,5 Kg

**Notes**  
USB charging connection.  
LED on/off switch under the shelf.  
Electric cable 2,5 m.

**UNTIL STOCK RUNS OUT**

**1.725,00 €**



6006

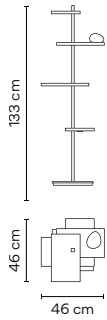

**Finishes**  
 ● 14/ \_\_ Chocolate (RAL 8019)  
 ● 93/ \_\_ White (RAL 9016)

**LED temperature colour**  
 /1\_ 2700 K  CRI >90 1539,64 lm 88 lm/W

**Control**  
 6006 \_\_ / \_ 5  
 Push

**1.845,00 €**

**Finish customization**  
 (Available options:  
 Vibia colour palette)

**Materials**  
 Shelf: Aluminum. Diffuser: Polycarbonate.  
 Vertical tube: Steel. Base: Steel. Lid: ABS with fiberglass.

**Light Source and electronics**  
 8 x LED STRIP 24V 1,63 W.  
 1 x LED 4,5 W 350 mA  
 Constant Current / Constant Voltage 350 24V  
 220-240V 50Hz

**Packaging**  
 1 Box 0,730 x 0,535 x 1,385 m  
 Vol 0,4513 m<sup>3</sup>  
 Gross weight 34,3 Kg Net weight 16,7 Kg

**Notes**  
 Glass diffuser mounted on shelf with dimmable light.  
 USB charging connection.  
 LED on/off switch under the shelf.  
 Electric cable 2,5 m.



6007

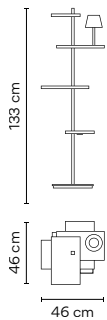

**Finishes**  
 ● 14/ \_\_ Chocolate (RAL 8019)  
 ● 93/ \_\_ White (RAL 9016)

**LED temperature colour**  
 /1\_ 2700 K  CRI >90 1539,64 lm 88 lm/W

**Control**  
 6007 \_\_ / \_ 5  
 Push

**1.965,00 €**

**Finish customization**  
 (Available options:  
 Vibia colour palette)

**Materials**  
 Shelf: Aluminum. Diffuser: Polycarbonate.  
 Vertical tube: Steel. Base: Steel. Lid: ABS with fiberglass.

**Light Source and electronics**  
 8 x LED STRIP 24V 1,63 W.  
 1 x LED 4,5 W 350 mA  
 Constant Current / Constant Voltage 350 24V  
 220-240V 50Hz

**Packaging**  
 1 Box 0,730 x 0,535 x 1,385 m  
 Vol 0,4513 m<sup>3</sup>  
 Gross weight 34,3 Kg Net weight 17 Kg

**Notes**  
 Reading light mink (Pantone 407C), mounted on shelf with dimmable light.  
 USB charging connection.  
 LED on/off switch under the shelf.  
 Electric cable 2,5 m.



6010

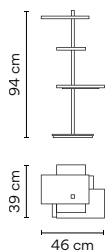

**Finishes**  
 ● 14/ \_\_ Chocolate (RAL 8019)  
 ● 93/ \_\_ White (RAL 9016)

**LED temperature colour**  
 /1\_ 2700 K  CRI >90 791 lm 77 lm/W

**Control**  
 6010 \_\_ / \_ 0  
 On/ Off

**1.445,00 €**

**Finish customization**  
 (Available options:  
 Vibia colour palette)

**Materials**  
 Shelf: Aluminum. Diffuser: Polycarbonate.  
 Vertical tube: Steel. Base: Steel. Lid: ABS with fiberglass.

**Light Source and electronics**  
 6 x LED STRIP 24V 1,63 W  
 Constant Voltage 24V  
 220-240V 50Hz

**Packaging**  
 1 Box 0,45 x 0,80 x 0,20 m  
 Vol 0,0072 m<sup>3</sup>  
 Gross weight 16,10 Kg Net weight 16,10 Kg

**Notes**  
 USB charging connection.  
 LED on/off switch under the shelf.  
 Electric cable 2,5 m.

**UNTIL STOCK RUNS OUT**

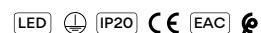

**6011**

|  |  |                       |                   |
|--|--|-----------------------|-------------------|
| <b>Finishes</b>                          | <b>LED temperature colour</b>  | <b>Control</b>        |                   |
| ● <b>14/</b> _ _ Chocolate<br>(RAL 8019) | <b>/1</b> _ 2700 K  | <b>6011</b> _ _ / _ 5 | <b>1.560,00 €</b> |
| ● <b>93/</b> _ _ White<br>(RAL 9016)     | CRI >90 790,98 lm 55 lm/W  | Push                  |                   |

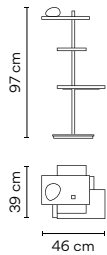

**Finish customization**  
(Available options:  
Vibia colour palette)

#### Materials

Shelf: Aluminum. Diffuser: Polycarbonate.  
Vertical tube: Steel. Base: Steel. Lid: ABS with fiberglass.

#### Light Source and electronics

6 x LED STRIP 24V 1,63 W.  
1 x LED 4,5 W 350 mA  
Constant Current / Constant Voltage 350 24V  
220-240V 50Hz

#### Packaging

1 Box 0,730 x 0,535 x 1,385 m  
Vol 0,3623 m<sup>3</sup>  
Gross weight 32,4 Kg Net weight 15,7 Kg

#### Notes

Glass diffuser mounted on shelf  
with dimmable light.  
USB charging connection.  
LED on/off switch under the shelf.  
Electric cable 2,5 m

**6012**

|  |   |                       |                   |
|--|---|-----------------------|-------------------|
| <b>Finishes</b>                          | <b>LED temperature colour</b>   | <b>Control</b>        |                   |
| ● <b>14/</b> _ _ Chocolate<br>(RAL 8019) | <b>/1</b> _ 2700 K  | <b>6012</b> _ _ / _ 5 | <b>1.695,00 €</b> |
| ● <b>93/</b> _ _ White<br>(RAL 9016)     | CRI >90 1275,98 lm 89 lm/W  | Push                  |                   |

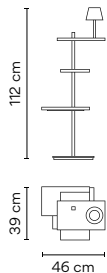

**Finish customization**  
(Available options:  
Vibia colour palette)

#### Materials

Shelf: Aluminum. Diffuser: Polycarbonate.  
Vertical tube: Steel. Base: Steel. Lid: ABS with fiberglass.

#### Light Source and electronics

6 x LED STRIP 24V 1,63 W.  
1 x LED 4,5 W 350 mA  
Constant Current / Constant Voltage 350 24V  
220-240V 50Hz

#### Packaging

1 Box 0,730 x 0,535 x 1,385 m  
Vol 0,3623 m<sup>3</sup>  
Gross weight 33,6 Kg Net weight 16 Kg

#### Notes

Reading light mink (Pantone 407C),  
mounted on shelf with dimmable light.  
USB charging connection.  
LED on/off switch under the shelf.  
Electric cable 2,5 m

**6025**

|  |  |                       |                   |
|--|--|-----------------------|-------------------|
| <b>Finishes</b>                          | <b>LED temperature colour</b>  | <b>Control</b>        |                   |
| ● <b>14/</b> _ _ Chocolate<br>(RAL 8019) | <b>/1</b> _ 2700 K  | <b>6025</b> _ _ / _ 0 | <b>1.500,00 €</b> |
| ● <b>93/</b> _ _ White<br>(RAL 9016)     | CRI >90 1054,6 lm 78 lm/W  | On/ Off               |                   |

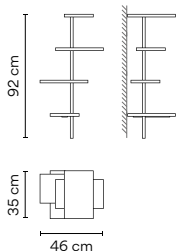

**Finish customization**  
(Available options:  
Vibia colour palette)

#### Materials

Shelf: Aluminum. Diffuser: Polycarbonate.  
Vertical tube: Steel. Lid: ABS with fiberglass.

#### Light Source and electronics

8 x LED STRIP 24V 1,63W  
Constant Voltage 24V  
220-240V 50Hz





#### Packaging

1 Box 0,61 x 0,54 x 1,1 m  
Vol 0,3623 m<sup>3</sup>  
Gross weight 11 Kg Net weight 5,6 Kg

#### Notes

USB charging connection.  
LED on/off switch under the shelf.  
Electric cable 2,5 m.

**UNTIL STOCK RUNS OUT**

6026

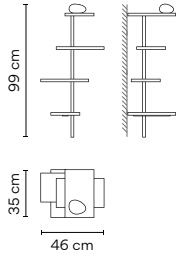

Finishes  
 ● 14/ \_\_ Chocolate (RAL 8019)  
 ● 93/ \_\_ White (RAL 9016)

LED temperature colour  
 /1\_ 2700 K CRI >90 1539,6 lm 88 lm/W

Control  
 6026 \_\_ / \_ 5  
 Push 1.610,00 €

Finish customization  
 (Available options:  
 Vibia colour palette)

Materials  
 Shelf: Aluminum. Diffuser: Polycarbonate.  
 Vertical tube: Steel. Lid: ABS with fiberglass.

Light Source and electronics  
 8 x LED STRIP 24V 1,63 W.  
 1 x LED 4,5 W 350 mA  
 Constant Current / Constant Voltage 350 24V  
 220-240V 50Hz

Packaging  
 1 Box 0,61 x 0,54 x 1,1 m  
 Vol 0,3623 m<sup>3</sup>  
 Gross weight 11,2 Kg Net weight 5,8 Kg

Notes  
 Glass diffuser mounted  
 on shelf with dimmable light.  
 USB charging connection.  
 LED on/off switch under the shelf.  
 Electric cable 2,5 m.

UNTIL STOCK RUNS OUT



6027

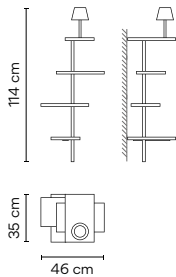

Finishes  
 ● 14/ \_\_ Chocolate (RAL 8019)  
 ● 93/ \_\_ White (RAL 9016)

LED temperature colour  
 /1\_ 2700 K CRI >90 1539,6 lm 88 lm/W

Control  
 6027 \_\_ / \_ 5  
 Push 1.745,00 €

Finish customization  
 (Available options:  
 Vibia colour palette)

Materials  
 Shelf: Aluminum. Diffuser: Polycarbonate.  
 Vertical tube: Steel. Lid: ABS with fiberglass.

Light Source and electronics  
 8 x LED STRIP 24V 1,63 W.  
 1 x LED 4,5 W 350 mA  
 Constant Current / Constant Voltage 350 24V  
 220-240V 50Hz

Packaging  
 1 Box 0,61 x 0,54 x 1,1 m  
 Vol 0,4513 m<sup>3</sup>  
 Gross weight 12,4 Kg Net weight 6,1 Kg

Notes  
 Reading light mink (Pantone 407C),  
 mounted on shelf with dimmable light.  
 USB charging connection.  
 LED on/off switch under the shelf.  
 Electric cable 2,5 m.

UNTIL STOCK RUNS OUT



6030

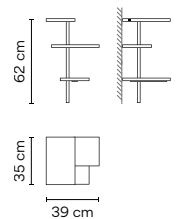

Finishes  
 ● 14/ \_\_ Chocolate (RAL 8019)  
 ● 93/ \_\_ White (RAL 9016)

LED temperature colour  
 /1\_ 2700 K CRI >90 791,0 lm 77 lm/W

Control  
 6030 \_\_ / \_ 0  
 On/ Off 1.230,00 €

Finish customization  
 (Available options:  
 Vibia colour palette)

Materials  
 Shelf: Aluminum. Diffuser: Polycarbonate.  
 Vertical tube: Steel. Lid: ABS with fiberglass.









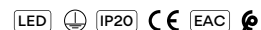

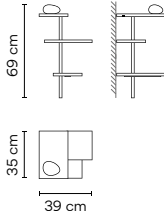

Light Source and electronics  
 6 x LED STRIP 24V 1,63 W  
 Constant Voltage 24V  
 220-240V 50Hz

Packaging  
 1 Box 0,61 x 0,54 x 1,1 m  
 Vol 0,3623 m<sup>3</sup>  
 Gross weight 9,8 Kg Net weight 4,4 Kg

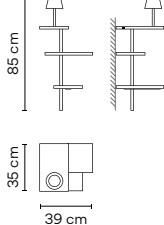
Notes  
 USB charging connection.  
 LED on/off switch under the shelf.  
 Electric cable 2,5 m.

UNTIL STOCK RUNS OUT



|  |   |  |  |            |
|--|---|--|--|------------|
| 6031   | <b>Finishes</b><br>● 14/ _ _ Chocolate<br>(RAL 8019)<br>● 93/ _ _ White<br>(RAL 9016) | <b>LED temperature colour</b><br>/1_ 2700 K <br>CRI >90 791,0 lm 55 lm/W                              | <b>Control</b><br>6031 _ _ / _ 5<br>Push | 1.340,00 € |
|   | <b>Finish customization</b><br>(Available options:<br>Vibia colour palette)           |  |  |            |
| <b>Materials</b><br>Shelf: Aluminum. Diffuser: Polycarbonate.<br>Vertical tube: Steel. Lid: ABS with fiberglass  |   | <b>Packaging</b><br>1 Box 0,61 x 0,54 x 1,1 m<br>Vol 0,3623 m <sup>3</sup><br>Gross weight 10 Kg Net weight 4,6 Kg   |  |            |
| <b>Light Source and electronics</b><br>6 x LED STRIP 24V 1,63 W.<br>1 x LED 4,5 W 350 mA<br>Constant Current / Constant Voltage 350 24V<br>220-240V 50Hz   |   | <b>Notes</b><br>Glass diffuser mounted on shelf<br>with dimmable light.<br>USB charging connection.<br>LED on/off switch under the shelf.<br>Electric cable 2,5 m.                     |  |            |
| <b>UNTIL STOCK RUNS OUT</b>  |   |  |  |            |
|                |   |  |  |            |
| 6032   | <b>Finishes</b><br>● 14/ _ _ Chocolate<br>(RAL 8019)<br>● 93/ _ _ White<br>(RAL 9016) | <b>LED temperature colour</b><br>/1_ 2700 K <br>CRI >90 791,0 lm 55 lm/W                            | <b>Control</b><br>6032 _ _ / _ 5<br>Push | 1.470,00 € |
|   | <b>Finish customization</b><br>(Available options:<br>Vibia colour palette)           |  |  |            |
| <b>Materials</b><br>Shelf: Aluminum. Diffuser: Polycarbonate.<br>Vertical tube: Steel. Lid: ABS with fiberglass.   |   | <b>Packaging</b><br>1 Box 0,61 x 0,54 x 1,1 m<br>Vol 0,3623 m <sup>3</sup><br>Gross weight 10,3 Kg Net weight 4,9 Kg   |  |            |
| <b>Light Source and electronics</b><br>6 x LED STRIP 24V 1,63 W.<br>1 x LED 4,5 W 350 mA<br>Constant Current / Constant Voltage 350 24V<br>220-240V 50Hz   |   | <b>Notes</b><br>Reading light mink (Pantone 407C),<br>mounted on shelf with dimmable light.<br>USB charging connection.<br>LED on/off switch under the shelf.<br>Electric cable 2,5 m. |  |            |
| <b>UNTIL STOCK RUNS OUT</b>  |   |  |  |            |
|      |   |  |  |            |

Wall



**6035**

|  |   |                       |
|--|---|-----------------------|
| <b>Finishes</b>                          | <b>LED temperature colour</b>   | <b>Control</b>        |
| ● <b>14/ _ _ Chocolate</b><br>(RAL 8019) | <b>/1_ 2700 K</b>  | <b>6035 _ _ / _ 0</b> |
| ● <b>93/ _ _ White</b><br>(RAL 9016)     | CRI >90 131,8 lm 81 lm/W  | <b>270,00 €</b>       |

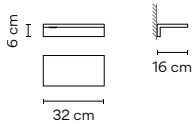

**Finish customization**  
(Available options:  
Vibia colour palette)

**Materials**  
Shelf: Aluminum. Diffuser: Polycarbonate.  
Lid: Steel.

**Light Source and electronics**  
1 x LED STRIP 24V 1,63 W  
Constant Voltage 24V  
220-240V 50Hz

**Packaging**  
1 Box 0,21 x 0,48 x 0,21 m  
Vol 0,0212 m<sup>3</sup>  
Gross weight 1,8 Kg Net weight 1,5 Kg

**Notes**  
**UNTIL STOCK RUNS OUT**

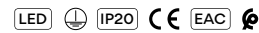

**6040**

|  |   |                       |
|--|---|-----------------------|
| <b>Finishes</b>                          | <b>LED temperature colour</b>   | <b>Control</b>        |
| ● <b>14/ _ _ Chocolate</b><br>(RAL 8019) | <b>/1_ 2700 K</b>  | <b>6040 _ _ / _ 0</b> |
| ● <b>93/ _ _ White</b><br>(RAL 9016)     | CRI >90 485 lm 121 lm/W   | <b>350,00 €</b>       |

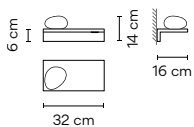

**Finish customization**  
(Available options:  
Vibia colour palette)

**Materials**  
Shelf: Aluminum. Diffuser: Blown-glass.  
Lid: Steel.

**Light Source and electronics**  
1 x LED 4,5 W 350 mA  
Constant Current 350 mA  
220-240V 50Hz

**Packaging**  
1 Box 0,21 x 0,48 x 0,21 m  
Vol 0,0212 m<sup>3</sup>  
Gross weight 2,6 Kg Net weight 1,6 Kg

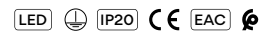

**6041**

|  |   |                       |
|--|---|-----------------------|
| <b>Finishes</b>                          | <b>LED temperature colour</b>   | <b>Control</b>        |
| ● <b>14/ _ _ Chocolate</b><br>(RAL 8019) | <b>/1_ 2700 K</b>  | <b>6041 _ _ / _ 0</b> |
| ● <b>93/ _ _ White</b><br>(RAL 9016)     | CRI >90 485 lm 121 lm/W   | <b>350,00 €</b>       |

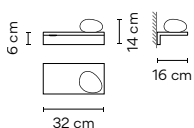

**Finish customization**  
(Available options:  
Vibia colour palette)

**Materials**  
Shelf: Aluminum. Diffuser: Blown-glass.  
Lid: Steel.

**Light Source and electronics**  
1 x LED 4,5 W 350 mA  
Constant Current 350 mA  
220-240V 50/60Hz

**Packaging**  
1 Box 0,21 x 0,48 x 0,21 m  
Vol 0,0212 m<sup>3</sup>  
Gross weight 2,6 Kg Net weight 1,6 Kg

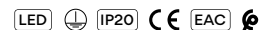

6045

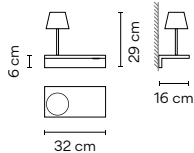

Finishes  
 ● 14/ \_\_ Chocolate (RAL 8019)  
 ● 93/ \_\_ White (RAL 9016)

LED temperature colour  
 /1\_ 2700 K CRI >90 616,83 lm 101 lm/W

Control  
 6045 \_\_ / \_\_ 0  
 On/ Off

520,00 €

Finish customization  
 (Available options:  
 Vibia colour palette)

Materials  
 Shelf: Aluminum. Diffuser: Polycarbonate.  
 Lid: Steel.

Light Source and electronics  
 1 x LED STRIP 24V 1,63W.  
 1 x LED 4,5W 350mA.  
 Constant Current / Constant Voltage 350 24V  
 220~240V 50Hz

Packaging  
 1 Box 0,29 x 0,38 x 0,38 m  
 Vol 0,418 m<sup>3</sup>  
 Gross weight 2,6 Kg Net weight 1,8 Kg

6046

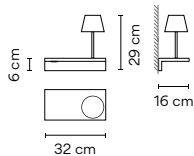

Finishes  
 ● 14/ \_\_ Chocolate (RAL 8019)  
 ● 93/ \_\_ White (RAL 9016)

LED temperature colour  
 /1\_ 2700 K CRI >90 616,83 lm 101 lm/W

Control  
 6046 \_\_ / \_\_ 0  
 On/ Off

520,00 €

Finish customization  
 (Available options:  
 Vibia colour palette)

Materials  
 Shelf: Aluminum. Diffuser: Polycarbonate.  
 Lid: Steel.

Light Source and electronics  
 1 x LED STRIP 24V 1,63W.  
 1 x LED 4,5W 350mA.  
 Constant Current / Constant Voltage 350 24V  
 220~240V 50Hz

Packaging  
 1 Box 0,29 x 0,38 x 0,38 m  
 Vol 0,418 m<sup>3</sup>  
 Gross weight 2,6 Kg Net weight 1,8 Kg

6050

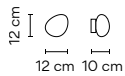

Finishes  
 ● 93/ \_\_ White (RAL 9016)

LED temperature colour  
 /1\_ 2700 K CRI >90 485 lm 121 lm/W

Control  
 6050 \_\_ / \_\_ 0  
 On/ Off

285,00 €

Materials  
 Wall support: Aluminum.  
 Diffuser: Blown-glass

Light Source and electronics  
 1 x LED 4,5W 350 mA  
 Constant Current 350 mA  
 100~240V 50/60Hz

Packaging  
 1 Box 0,13 x 0,20 x 0,21 m  
 Vol 0,00055 m<sup>3</sup>  
 Gross weight 0,6 Kg Net weight 0,4 Kg

# Tube

Design by Ichiro Iwasaki

Shade Landscape. A fluid gesture outlines the tubes, which when set out over a space become the structure that facilitates a meeting of the shades in a harmonious coming together.

---

## Ceiling Pendants

**6100**

ø 28,5 cm



**6105**

ø 41 cm



**6110**

ø 52 cm



**6115**

97 cm



**6160**



ø 22 cm

**6165**



ø 28,5 cm



Each project is unique. Visit [vibia.com](http://vibia.com) and chose among multiple compositions designed and adapted to your project needs.

Personalise your own Tube composition quick and easy at [vibia.com](http://vibia.com)

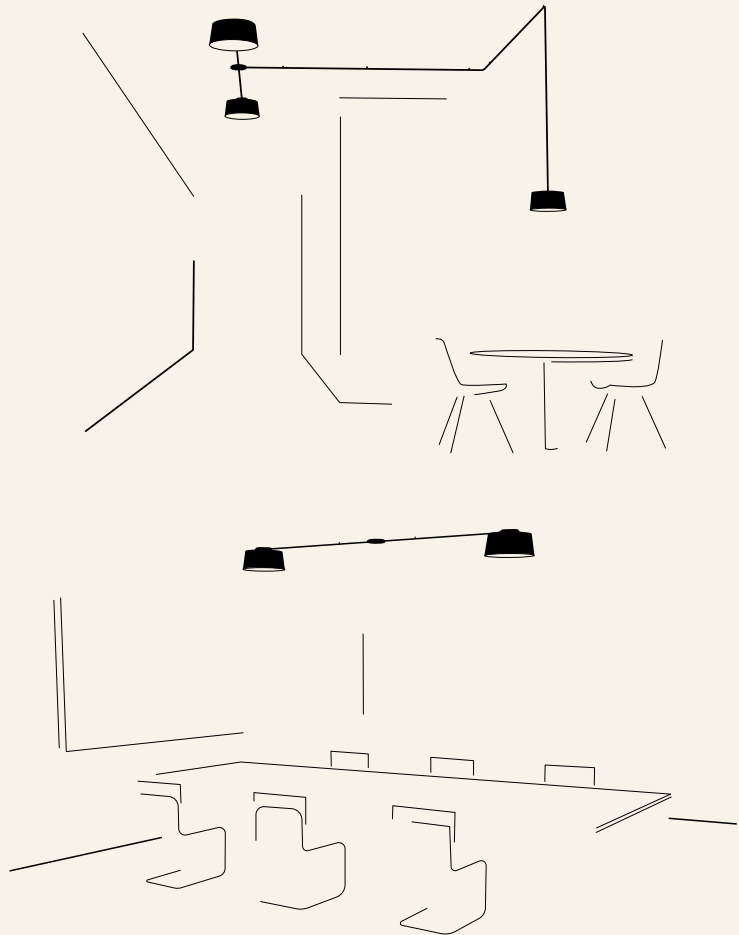

6100

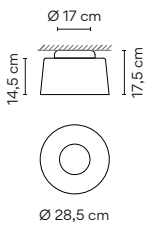

Finishes

- 10/ \_\_ White (NCS S 0300-N)
- 15/ \_\_ Grey L2 (NCS S 2500-N)
- 16/ \_\_ Grey M1 (NCS S 4500-N)
- 21/ \_\_ Black Grey (NCS S 7000-N)
- 24/ \_\_ Beige M1 (NCS S 2005-Y50R)
- 37/ \_\_ Terra Red (NCS S 4040-Y70R)

LED temperature colour

- /1 \_ 2700 K CRI >90 1476,7 lm 109 lm/W
- /2 \_ 3000 K CRI >90 1521,0 lm 113 lm/W
- /3 \_ 3500 K CRI >90 1550,6 lm 114,9 lm/W

Control

6100 \_\_ / \_ A 650,00 €  
 DALI-2

Materials

Diffuser: Polycarbonate. Led support: Aluminum.  
 Shade: Aluminum. Canopy: Steel.

Light Source and electronics

1 x LED PLATE 13,5 W 700 mA  
 Constant Current 700 mA  
 110-240V 50/60Hz

Packaging

1 Box 0,40 x 0,40 x 0,35 m  
 Vol 0,056 m<sup>3</sup>  
 Gross weight 4,5 Kg Net weight 2,5 Kg



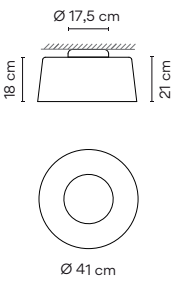

**6105**



**Finishes**

- 10/ \_\_ White (NCS S 0300-N)
- 15/ \_\_ Grey L2 (NCS S 2500-N)
- 16/ \_\_ Grey M1 (NCS S 4500-N)
- 21/ \_\_ Black Grey (NCS S 7000-N)
- 24/ \_\_ Beige M1 (NCS S 2005-Y50R)
- 37/ \_\_ Terra Red (NCS S 4040-Y70R)

**LED temperature colour**

- /1 \_ 2700 K  CRI >90 2413,2 lm 121 lm/W
- /2 \_ 3000 K  CRI >90 2485,6 lm 124 lm/W
- /3 \_ 3500 K  CRI >90 2533,9 lm 126,7 lm/W

**Control**





6105 \_\_ / \_ A **760,00 €**  
DALI-2

---

**Materials**  
Diffuser: Polycarbonate. Led support: Aluminum.  
Shade: Aluminum. Canopy: Steel.

**Light Source and electronics**  
1 x LED PLATE 20 W 700 mA  
Constant Current 700 mA  
110-240V 50/60Hz

**Packaging**  
1 Box 0,60 x 0,60 x 0,40 m  
Vol 0,144 m<sup>3</sup>  
Gross weight 5,5 Kg Net weight 3,5 Kg

LED  IP20   

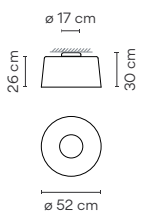

**6110**



**Finishes**

- 10/ \_\_ White (NCS S 0300-N)
- 15/ \_\_ Grey L2 (NCS S 2500-N)
- 16/ \_\_ Grey M1 (NCS S 4500-N)
- 21/ \_\_ Black Grey (NCS S 7000-N)
- 24/ \_\_ Beige M1 (NCS S 2005-Y50R)
- 37/ \_\_ Terra Red (NCS S 4040-Y70R)

**LED temperature colour**

- /1 \_ 2700 K  CRI >90 3299,1 lm 132 lm/W
- /2 \_ 3000 K  CRI >90 3398,1 lm 136 lm/W
- /3 \_ 3500 K  CRI >90 3464,0 lm 138,6 lm/W

**Control**

6110 \_\_ / \_ A **885,00 €**  
DALI-2





---

**Materials**  
Diffuser: Polycarbonate. Led support: Aluminum.  
Shade: Aluminum. Canopy: Steel.

**Light Source and electronics**  
1 x LED PLATE 25 W 700 mA  
Constant Current 700 mA  
110-240V 50/60Hz

**Packaging**  
1 Box 0,60 x 0,60 x 0,40 m  
Vol 0,144 m<sup>3</sup>  
Gross weight 6,5 Kg Net weight 4,5 Kg

**Notes**  
**UNTIL STOCK RUNS OUT**

LED  IP20   

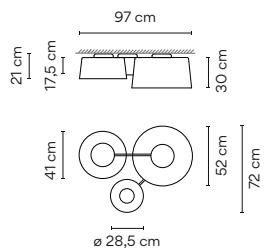

**6115**



**Finishes**

- 10/ \_\_ White (NCS S 0300-N)
- 24/ \_\_ Beige M1 (NCS S 2005-Y50R)
- 37/ \_\_ Terra Red (NCS S 4040-Y70R)
- 71/ \_\_ Grey L2, Grey M1, Black Grey (NCS S 2500-N, NCS S 4500-N, NCS S 7000-N)

**LED temperature colour**

- /1 \_ 2700 K  CRI >90 7189,0 lm 123 lm/W
- /2 \_ 3000 K  CRI >90 7404,7 lm 127 lm/W
- /3 \_ 3500 K  CRI >90 7548,5 lm 129 lm/W

**Control**

6115 \_\_ / \_ A **2.085,00 €**  
DALI-2





---

**Materials**  
Diffuser: Polycarbonate. Led support: Aluminum.  
Shade: Aluminum. Canopy: Steel.

**Light Source and electronics**  
1 x LED PLATE 13,5 W 700 mA  
1 x LED PLATE 20 W 700 mA  
1 x LED PLATE 25 W 700 mA  
Constant Current 700 mA  
110-240V 50/60Hz

**Packaging**  
1 Box 1 x 1 x 0,40 m  
Vol 0,40 m<sup>3</sup>  
Gross weight 16 Kg Net weight 12 Kg

**Notes**  
Require only one electrical connection on the big shade.  
**UNTIL STOCK RUNS OUT**

LED  IP20   

## 6160

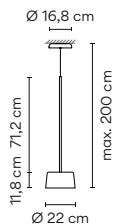

| Finishes   | LED temperature colour   | Control  |               |          |      |  |               |          |             |  |               |          |         |  |
|--|--|--|---------------|----------|------|--|---------------|----------|-------------|--|---------------|----------|---------|--|
| <ul style="list-style-type: none"> <li>● 10/ __ White (NCS S 0300-N)</li> <li>● 15/ __ Grey L2 (NCS S 2500-N)</li> <li>● 16/ __ Grey M1 (NCS S 4500-N)</li> <li>● 21/ __ Black Grey (NCS S 7000-N)</li> <li>● 24/ __ Beige M1 (NCS S 2005-Y50R)</li> <li>● 37/ __ Terra Red (NCS S 4040-Y70R)</li> </ul> | <ul style="list-style-type: none"> <li>/1 _ 2700 K  CRI &gt;90 1170 lm 111 lm/W</li> <li>/2 _ 3000 K  CRI &gt;90 1251 lm 119 lm/W</li> <li>/3 _ 3500 K  CRI &gt;90 1251 lm 119 lm/W</li> </ul> | <table border="0"> <tr> <td>6160 __ / _ 1</td> <td>545,00 €</td> </tr> <tr> <td colspan="2">DALI</td> </tr> <tr> <td>6160 __ / _ B</td> <td>515,00 €</td> </tr> <tr> <td colspan="2">1-10V, Push</td> </tr> <tr> <td>6160 __ / _ Z</td> <td>635,00 €</td> </tr> <tr> <td colspan="2">Casambi</td> </tr> </table> | 6160 __ / _ 1 | 545,00 € | DALI |  | 6160 __ / _ B | 515,00 € | 1-10V, Push |  | 6160 __ / _ Z | 635,00 € | Casambi |  |
| 6160 __ / _ 1  | 545,00 €   |  |               |          |      |  |               |          |             |  |               |          |         |  |
| DALI   |  |  |               |          |      |  |               |          |             |  |               |          |         |  |
| 6160 __ / _ B  | 515,00 €   |  |               |          |      |  |               |          |             |  |               |          |         |  |
| 1-10V, Push  |  |  |               |          |      |  |               |          |             |  |               |          |         |  |
| 6160 __ / _ Z  | 635,00 €   |  |               |          |      |  |               |          |             |  |               |          |         |  |
| Casambi  |  |  |               |          |      |  |               |          |             |  |               |          |         |  |

Finish customization  
(Available options:  
Vibia colour palette)

### Materials

Diffuser: Polycarbonate. Shade: Aluminum.  
Led support: Aluminum. Tube: Steel. Canopy: Steel.

### Light Source and electronics

1 x LED PLATE 10,5 W  
Constant Current 700 mA  
110-240V 50/60Hz

### Packaging

Total Vol 0,04 m3  
Gross weight 4,2 Kg Net weight 1,6 Kg

### Notes

Extra cable length. 16,00 €/m

### Electrical connection

Surface  
\_18 Free Wire  
\_23 Built-in  
\_31 Remote  
Micro  
for plaster  
ceilings  
\_32 Remote  
XXS  
for all types  
of drop  
ceilings

## 6165

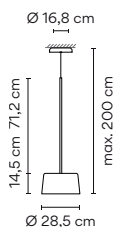

| Finishes   | LED temperature colour   | Control  |               |          |      |  |               |          |             |  |               |          |         |  |
|--|--|--|---------------|----------|------|--|---------------|----------|-------------|--|---------------|----------|---------|--|
| <ul style="list-style-type: none"> <li>● 10/ __ White (NCS S 0300-N)</li> <li>● 15/ __ Grey L2 (NCS S 2500-N)</li> <li>● 16/ __ Grey M1 (NCS S 4500-N)</li> <li>● 21/ __ Black Grey (NCS S 7000-N)</li> <li>● 24/ __ Beige M1 (NCS S 2005-Y50R)</li> <li>● 37/ __ Terra Red (NCS S 4040-Y70R)</li> </ul> | <ul style="list-style-type: none"> <li>/1 _ 2700 K  CRI &gt;90 1170 lm 111 lm/W</li> <li>/2 _ 3000 K  CRI &gt;90 1251 lm 119 lm/W</li> <li>/3 _ 3500 K  CRI &gt;90 1251 lm 119 lm/W</li> </ul> | <table border="0"> <tr> <td>6165 __ / _ 1</td> <td>655,00 €</td> </tr> <tr> <td colspan="2">DALI</td> </tr> <tr> <td>6165 __ / _ B</td> <td>620,00 €</td> </tr> <tr> <td colspan="2">1-10V, Push</td> </tr> <tr> <td>6165 __ / _ Z</td> <td>740,00 €</td> </tr> <tr> <td colspan="2">Casambi</td> </tr> </table> | 6165 __ / _ 1 | 655,00 € | DALI |  | 6165 __ / _ B | 620,00 € | 1-10V, Push |  | 6165 __ / _ Z | 740,00 € | Casambi |  |
| 6165 __ / _ 1  | 655,00 €   |  |               |          |      |  |               |          |             |  |               |          |         |  |
| DALI   |  |  |               |          |      |  |               |          |             |  |               |          |         |  |
| 6165 __ / _ B  | 620,00 €   |  |               |          |      |  |               |          |             |  |               |          |         |  |
| 1-10V, Push  |  |  |               |          |      |  |               |          |             |  |               |          |         |  |
| 6165 __ / _ Z  | 740,00 €   |  |               |          |      |  |               |          |             |  |               |          |         |  |
| Casambi  |  |  |               |          |      |  |               |          |             |  |               |          |         |  |

Finish customization  
(Available options:  
Vibia colour palette)

### Materials

Diffuser: Polycarbonate. Shade: Aluminum.  
Led support: Aluminum. Tube: Steel. Canopy: Steel.

### Light Source and electronics

1 x LED PLATE 13,5 W  
Constant Current 700 mA  
110-240V 50/60Hz

### Packaging

Total Vol 0,04 m3  
Gross weight 4,3 Kg Net weight 1,7 Kg

### Notes

Extra cable length. 16,00 €/m

### Electrical connection

Surface  
\_18 Free Wire  
\_23 Built-in  
\_31 Remote  
Micro  
for plaster  
ceilings  
\_32 Remote  
XXS  
for all types  
of drop  
ceilings

# Composing pendants

Next sketches are composed by one or more compositions

---

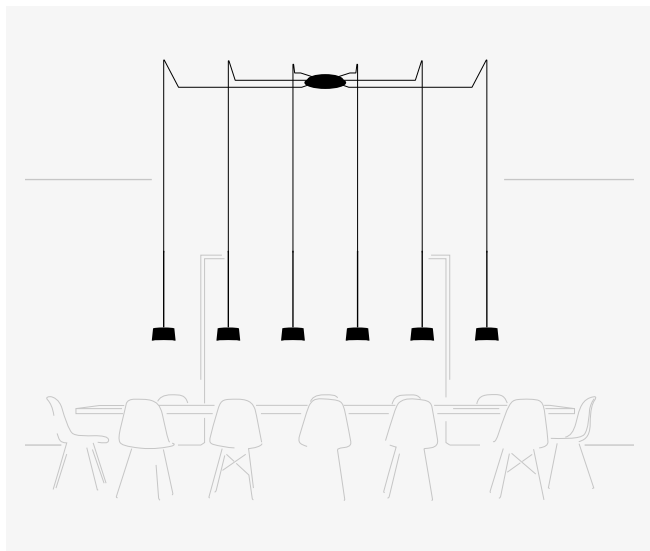

6 x 6165.

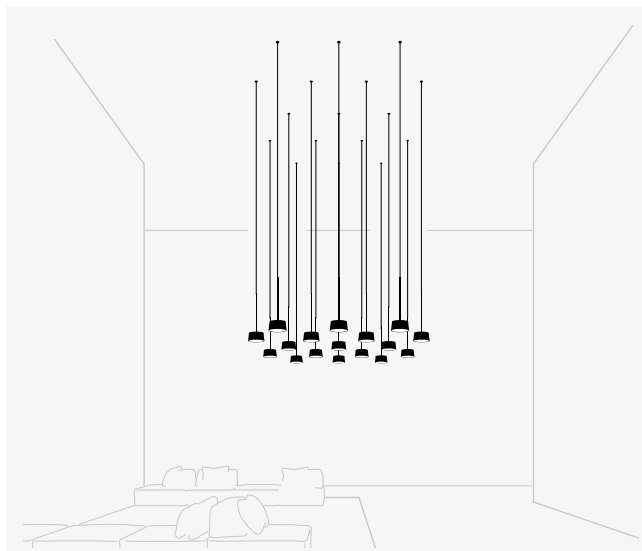

17 x 6160.

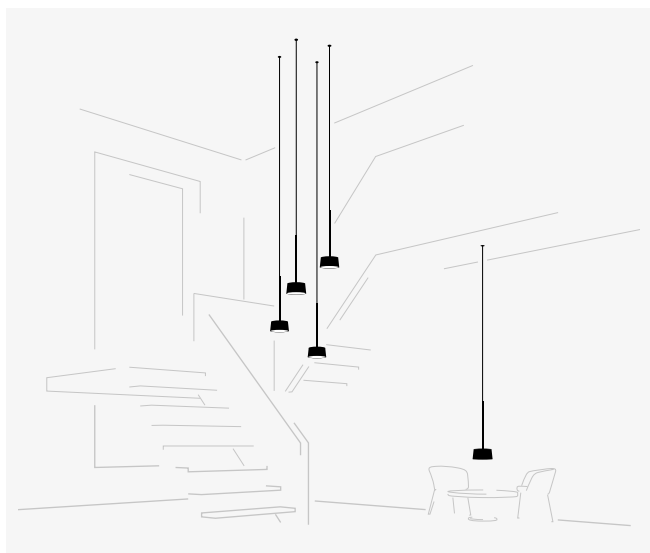

5 x 6160.

Each project is unique.  
Visit [vibia.com](http://vibia.com) and  
chose among multiple  
compositions designed  
and adapted to your  
project needs.

Personalise your own  
Tube composition quick  
and easy at [vibia.com](http://vibia.com)



# Electrical connection options for models 6160 / 6165

Choose your preferred installation option according to your needs. For each composition, the optimal minimum number of drivers will be delivered.

## Drop ceiling

The innovative remote and built-in fittings accentuate the silkiness and lightness of compositions on suspended ceilings, its great visual grandeur taking center stage.

For Ref. 6160 / 6165

### Remote

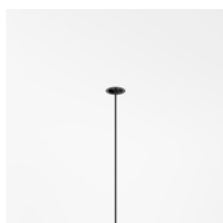

**Micro** ø 3 cm  
height 7 cm  
for plaster ceilings.  
Black finish.

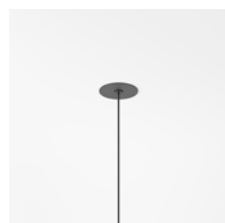
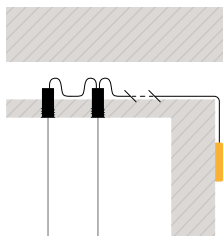

**XXS** ø 6 cm  
height 6 cm  
for all types of drop ceilings. Match with fixture finish.

### Built-in



ø 8 cm  
height 6 cm  
match with fixture finish.

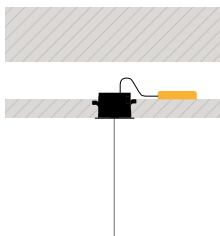

---

## Regular ceiling

When architecture does not allow for performance, surface and free wire showcase possibilities for any need or desire with no limits, ideal for both individual or cluster arrangements.

For Ref. 6160 / 6165

### Surface



ø 16,8 cm  
match with  
fixture finish.

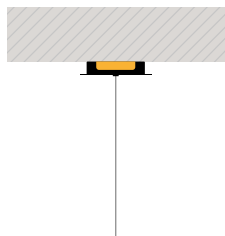

### Free Wire



1 wire

ø 20 cm

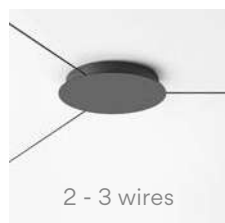

2 - 3 wires

ø 22 cm



4 - 6 wires

ø 36 cm



7 - 9 wires

ø 40 cm

you can choose the finish of the canopy  
among black, white or any colour  
matching one of the pendants.

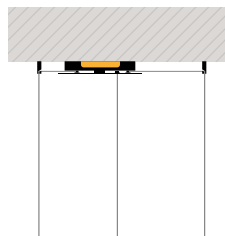

# Plusminus

Design by Diez Office.

Plusminus is a versatile lighting system that takes the concept of the light rail to a new level.

The conductive textile ribbon at its core allows for free placement of the luminaires and the creation of unique light solutions on the spot.







## Easy to design and install

Compose a personalised Plusminus at [vibia.com](https://vibia.com)

### From scratch



- + Create and compose projects in detail.
- + Draw and customise in 3D to see it in space.
- + Or customise it step by step without drawing.

### From a layout

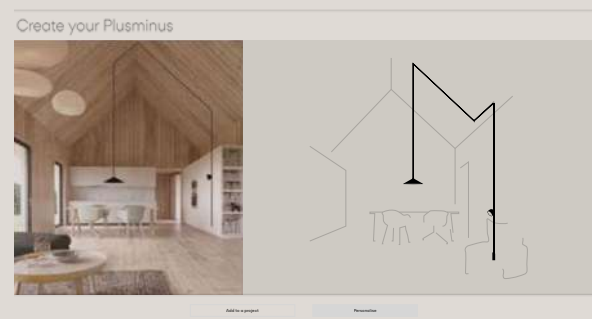

- + Customise and adapt it to the needs of your project.
- + Add it to your project and edit it at any time.
- + More than 100 creations for you.

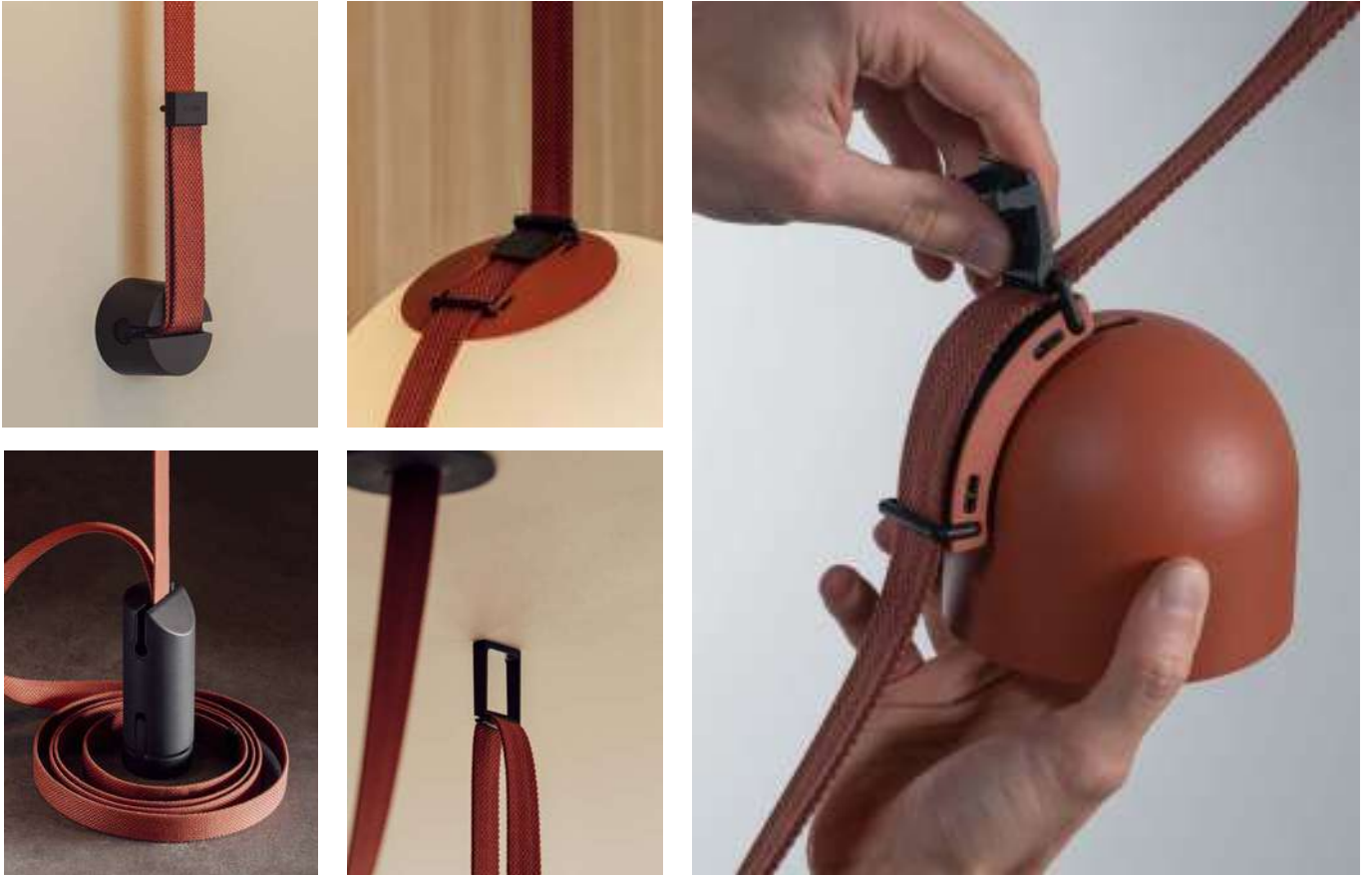

## Easy connection Fix / Click / Connect

Each belt, which can be cut as needed, accommodates multiple luminaires and operates with simple plug-in technology for unparalleled ease of installation and connection. The belt offers adjustments in tension from taut to relaxed as well as click-and-connect functionality, snapping into a buckle attached to each luminaire.

# Luminaire types and lighting effects



## Sphere



### **360° Diffusion lighting**

distributes light equally in all directions (360°). It attracts a relaxed gaze towards the point of light, and creates a calm, very comfortable atmosphere. The light sphere bathes all surfaces of the space, producing a peaceful, richer and extremely homogenous ambience.



## Semisphere



### **Directed diffusion lighting**

emits a soft light that generates low contrasts between the illuminated areas and the shadows cast. The opaque part of the shade helps to direct the light through the diffuser, providing illumination that is both peaceful and concentrated at the same time.



## Cone



### **Directed diffusion lighting**

emits a soft light that generates low contrasts between the illuminated areas and the shadows cast. The opaque part of the shade helps to direct the light through the diffuser, providing illumination that is both peaceful and concentrated at the same time.

## Spotlight

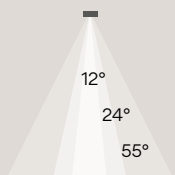

### Directed diffusion lighting

emits a soft light that generates low contrasts between the illuminated areas and the shadows cast. It is ideal for reading situations or when the light output is visible, as it does not produce glare.

### Accent lighting

emphasizes objects or architectural elements with intensive cones of light. Luminance contrasts attract the eye and bring the illuminated objects into the foreground. The light output is directed towards the object or architectural element and not towards the person, in order to avoid glare.



## Linear Diffuser

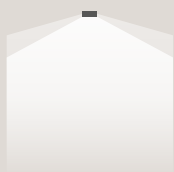

### General lighting

provides a high degree of uniformity on the horizontal plane and generates a first layer of illumination on which to add more specific lighting applications. It generates soft shadows and subdued brightness in which the space and its component elements do not display visual hierarchies.



## Linear Low UGR



### High-efficiency, low-glare general linear lighting

offers medium brightness and clarity of forms. Direct illumination, extended beam and luminaire performance enable installations with high-energy efficiencies and low-glare levels below UGR<19.

### High-comfort, low-glare general linear lighting

provides high levels of illumination and comfort with UGR levels below 19. It is also ideal for work or meeting areas.



# Luminaire types

It is not possible to order luminaires alone, you need to design your Plusminus on our website [vibia.com](http://vibia.com)

## Sphere



Ø 20 cm

**6230**



Ø 30 cm

**6235**

### 6230

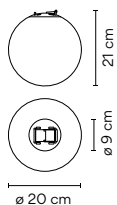

- Finishes**
- **11/** \_\_ Black (NCS S 8500-N)
  - **24/** \_\_ Beige M1 (NCS S 2005-Y50R)
  - **37/** \_\_ Terra Red (NCS S 4040-Y70R)
  - **42/** \_\_ Blue M1 (NCS S 5010-B10G)
  - **53/** \_\_ Green M1 (NCS S 6005-G80Y)

- LED temperature colour**
- /1** \_ 2700 K CRI >90 846 lm 107,09 lm/W
  - /2** \_ 3000 K CRI >90 884 lm 111,9 lm/W
  - /3** \_ 3500 K CRI >90 916 lm 115,95 lm/W

- Control**
- |   |                 |
|---|-----------------|
| <b>6230</b> __ / _ <b>O</b><br>On/ Off  | <b>285,00 €</b> |
| <b>6230</b> __ / _ <b>F</b><br>Simultaneous line<br>DALI, 1-10V, Push, Casambi          | <b>315,00 €</b> |
| <b>6230</b> __ / _ <b>Z</b><br>Casambi integrated on each<br>individual luminaire (P2P) | <b>435,00 €</b> |

**Materials**  
Diffuser: Triplex opal glass.  
Body: Aluminum.

**Light Source and electronics**  
1 x LED 7,9 W 450 mA

**Packaging**  
1 Box 0,26 x 0,26 x 0,260 m  
Vol 0,0175 m<sup>3</sup>  
Gross weight 1,56 Kg Net weight 0,93 Kg



### 6235

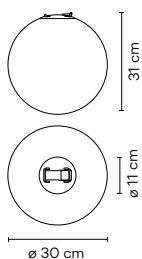

- Finishes**
- **11/** \_\_ Black (NCS S 8500-N)
  - **24/** \_\_ Beige M1 (NCS S 2005-Y50R)
  - **37/** \_\_ Terra Red (NCS S 4040-Y70R)
  - **42/** \_\_ Blue M1 (NCS S 5010-B10G)
  - **53/** \_\_ Green M1 (NCS S 6005-G80Y)

- LED temperature colour**
- /1** \_ 2700 K CRI >90 1492 lm 93,25 lm/W
  - /2** \_ 3000 K CRI >90 1569 lm 98,06 lm/W
  - /3** \_ 3500 K CRI >90 1606 lm 100,38 lm/W

- Control**
- |   |                 |
|---|-----------------|
| <b>6235</b> __ / _ <b>O</b><br>On/ Off  | <b>340,00 €</b> |
| <b>6235</b> __ / _ <b>F</b><br>Simultaneous line<br>DALI, 1-10V, Push, Casambi          | <b>370,00 €</b> |
| <b>6235</b> __ / _ <b>Z</b><br>Casambi integrated on each<br>individual luminaire (P2P) | <b>490,00 €</b> |

**Materials**  
Diffuser: Triplex opal glass.  
Body: Aluminum.

**Light Source and electronics**  
1 x LED 16 W 850 mA

**Packaging**  
1 Box 0,364 x 0,364 x 0,364 m  
Vol 0,0482 m<sup>3</sup>  
Gross weight 2,50 Kg Net weight 1,80 Kg



## Semisphere



Ø 20 cm

6220



Ø 30 cm

6225

### 6220

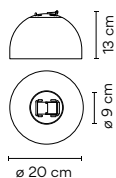

- Finishes**
- 11/ \_ \_ Black (NCS S 8500-N)
  - 24/ \_ \_ Beige M1 (NCS S 2005-Y50R)
  - 37/ \_ \_ Terra Red (NCS S 4040-Y70R)
  - 42/ \_ \_ Blue M1 (NCS S 5010-B10G)
  - 53/ \_ \_ Green M1 (NCS S 6005-G80Y)

- LED temperature colour**
- /1 \_ 2700 K CRI >90 846 lm 107,09 lm/W
  - /2 \_ 3000 K CRI >90 884 lm 111,9 lm/W
  - /3 \_ 3500 K CRI >90 916 lm 115,95 lm/W

- Control**
- |  |          |
|--|----------|
| 6220 _ _ / _ 0<br>On/ Off  | 305,00 € |
| 6220 _ _ / _ F<br>Simultaneous line<br>DALI, 1-10V, Push, Casambi          | 335,00 € |
| 6220 _ _ / _ Z<br>Casambi integrated on each<br>individual luminaire (P2P) | 455,00 € |

**Materials**  
 Shade: Aluminum.  
 Diffuser: Polycarbonate.

**Light Source and electronics**  
 1 x LED 7,9 W 450 mA

**Packaging**  
 1 Box 0,26 x 0,26 x 0,26 m  
 Vol 0,0175 m<sup>3</sup>  
 Gross weight 1,20 Kg Net weight 0,78 Kg



### 6225

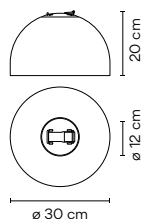

- Finishes**
- 11/ \_ \_ Black (NCS S 8500-N)
  - 24/ \_ \_ Beige M1 (NCS S 2005-Y50R)
  - 37/ \_ \_ Terra Red (NCS S 4040-Y70R)
  - 42/ \_ \_ Blue M1 (NCS S 5010-B10G)
  - 53/ \_ \_ Green M1 (NCS S 6005-G80Y)

- LED temperature colour**
- /1 \_ 2700 K CRI >90 1492 lm 93,25 lm/W
  - /2 \_ 3000 K CRI >90 1569 lm 98,06 lm/W
  - /3 \_ 3500 K CRI >90 1606 lm 100,38 lm/W

- Control**
- |  |          |
|--|----------|
| 6225 _ _ / _ 0<br>On/ Off  | 380,00 € |
| 6225 _ _ / _ F<br>Simultaneous line<br>DALI, 1-10V, Push, Casambi          | 410,00 € |
| 6225 _ _ / _ Z<br>Casambi integrated on each<br>individual luminaire (P2P) | 530,00 € |

**Materials**  
 Shade: Aluminum.  
 Diffuser: Polycarbonate.

**Light Source and electronics**  
 1 x LED 16 W 850 mA

**Packaging**  
 1 Box 0,364 x 0,364 x 0,364 m  
 Vol 0,0482 m<sup>3</sup>  
 Gross weight 2 Kg Net weight 1,5 Kg



# Luminaire types

It is not possible to order luminaires alone, you need to design your Plusminus on our website [vibia.com](http://vibia.com)

## Cone



Ø 60 cm

6240



Ø 80 cm

6245

|   |  |   |  |                              |                 |         |  |                              |                 |  |  |                              |                 |   |  |
|---|--|---|--|------------------------------|-----------------|---------|--|------------------------------|-----------------|--|--|------------------------------|-----------------|---|--|
| <p><b>6240</b></p>                                    | <p><b>Finishes</b></p> <ul style="list-style-type: none"> <li>● <b>11/</b> _ _ Black (NCS S 8500-N)</li> <li>● <b>24/</b> _ _ Beige M1 (NCS S 2005-Y50R)</li> <li>● <b>37/</b> _ _ Terra Red (NCS S 4040-Y70R)</li> <li>● <b>42/</b> _ _ Blue M1 (NCS S 5010-B10G)</li> <li>● <b>53/</b> _ _ Green M1 (NCS S 6005-G80Y)</li> </ul> | <p><b>LED temperature colour</b></p> <ul style="list-style-type: none"> <li><b>/1</b> _ 2700 K  CRI &gt;90 1492 lm 93,25 lm/W</li> <li><b>/2</b> _ 3000 K  CRI &gt;90 1569 lm 98,06 lm/W</li> <li><b>/3</b> _ 3500 K  CRI &gt;90 1606 lm 100,38 lm/W</li> </ul> | <p><b>Control</b></p> <table border="0"> <tr> <td><b>6240</b> _ _ / _ <b>0</b></td> <td><b>605,00 €</b></td> </tr> <tr> <td>On/ Off</td> <td></td> </tr> <tr> <td><b>6240</b> _ _ / _ <b>F</b></td> <td><b>635,00 €</b></td> </tr> <tr> <td>Simultaneous line DALI, 1-10V, Push, Casambi</td> <td></td> </tr> <tr> <td><b>6240</b> _ _ / _ <b>Z</b></td> <td><b>755,00 €</b></td> </tr> <tr> <td>Casambi integrated on each individual luminaire (P2P)</td> <td></td> </tr> </table> | <b>6240</b> _ _ / _ <b>0</b> | <b>605,00 €</b> | On/ Off |  | <b>6240</b> _ _ / _ <b>F</b> | <b>635,00 €</b> | Simultaneous line DALI, 1-10V, Push, Casambi |  | <b>6240</b> _ _ / _ <b>Z</b> | <b>755,00 €</b> | Casambi integrated on each individual luminaire (P2P) |  |
|   | <b>6240</b> _ _ / _ <b>0</b>   | <b>605,00 €</b>   |  |                              |                 |         |  |                              |                 |  |  |                              |                 |   |  |
| On/ Off   |  |   |  |                              |                 |         |  |                              |                 |  |  |                              |                 |   |  |
| <b>6240</b> _ _ / _ <b>F</b>                          | <b>635,00 €</b>  |   |  |                              |                 |         |  |                              |                 |  |  |                              |                 |   |  |
| Simultaneous line DALI, 1-10V, Push, Casambi          |  |   |  |                              |                 |         |  |                              |                 |  |  |                              |                 |   |  |
| <b>6240</b> _ _ / _ <b>Z</b>                          | <b>755,00 €</b>  |   |  |                              |                 |         |  |                              |                 |  |  |                              |                 |   |  |
| Casambi integrated on each individual luminaire (P2P) |  |   |  |                              |                 |         |  |                              |                 |  |  |                              |                 |   |  |

**Materials**

Shade: Aluminum.  
Diffuser: Triplex opal glass.

Light Source and electronics  
1 x LED 16 W 850 mA

**Packaging**

0,727 x 0,727 x 0,32 m  
Vol 0,1691 m<sup>3</sup>  
Gross weight 5 Kg Net weight 2,5 Kg



|   |  |   |  |                              |                 |         |  |                              |                 |  |  |                              |                 |   |  |
|---|--|---|--|------------------------------|-----------------|---------|--|------------------------------|-----------------|--|--|------------------------------|-----------------|---|--|
| <p><b>6245</b></p>                                    | <p><b>Finishes</b></p> <ul style="list-style-type: none"> <li>● <b>11/</b> _ _ Black (NCS S 8500-N)</li> <li>● <b>24/</b> _ _ Beige M1 (NCS S 2005-Y50R)</li> <li>● <b>37/</b> _ _ Terra Red (NCS S 4040-Y70R)</li> <li>● <b>42/</b> _ _ Blue M1 (NCS S 5010-B10G)</li> <li>● <b>53/</b> _ _ Green M1 (NCS S 6005-G80Y)</li> </ul> | <p><b>LED temperature colour</b></p> <ul style="list-style-type: none"> <li><b>/1</b> _ 2700 K  CRI &gt;90 1492 lm 93,25 lm/W</li> <li><b>/2</b> _ 3000 K  CRI &gt;90 1569 lm 98,06 lm/W</li> <li><b>/3</b> _ 3500 K  CRI &gt;90 1606 lm 100,38 lm/W</li> </ul> | <p><b>Control</b></p> <table border="0"> <tr> <td><b>6245</b> _ _ / _ <b>0</b></td> <td><b>810,00 €</b></td> </tr> <tr> <td>On/ Off</td> <td></td> </tr> <tr> <td><b>6245</b> _ _ / _ <b>F</b></td> <td><b>840,00 €</b></td> </tr> <tr> <td>Simultaneous line DALI, 1-10V, Push, Casambi</td> <td></td> </tr> <tr> <td><b>6245</b> _ _ / _ <b>Z</b></td> <td><b>960,00 €</b></td> </tr> <tr> <td>Casambi integrated on each individual luminaire (P2P)</td> <td></td> </tr> </table> | <b>6245</b> _ _ / _ <b>0</b> | <b>810,00 €</b> | On/ Off |  | <b>6245</b> _ _ / _ <b>F</b> | <b>840,00 €</b> | Simultaneous line DALI, 1-10V, Push, Casambi |  | <b>6245</b> _ _ / _ <b>Z</b> | <b>960,00 €</b> | Casambi integrated on each individual luminaire (P2P) |  |
|   | <b>6245</b> _ _ / _ <b>0</b>   | <b>810,00 €</b>   |  |                              |                 |         |  |                              |                 |  |  |                              |                 |   |  |
| On/ Off   |  |   |  |                              |                 |         |  |                              |                 |  |  |                              |                 |   |  |
| <b>6245</b> _ _ / _ <b>F</b>                          | <b>840,00 €</b>  |   |  |                              |                 |         |  |                              |                 |  |  |                              |                 |   |  |
| Simultaneous line DALI, 1-10V, Push, Casambi          |  |   |  |                              |                 |         |  |                              |                 |  |  |                              |                 |   |  |
| <b>6245</b> _ _ / _ <b>Z</b>                          | <b>960,00 €</b>  |   |  |                              |                 |         |  |                              |                 |  |  |                              |                 |   |  |
| Casambi integrated on each individual luminaire (P2P) |  |   |  |                              |                 |         |  |                              |                 |  |  |                              |                 |   |  |

**Materials**

Shade: Aluminum.  
Diffuser: Triplex opal glass.

Light Source and electronics  
1 x LED 16 W 850 mA

**Packaging**

1 Box 0,96 x 0,96 x 0,27 m  
Vol 0,2488 m<sup>3</sup>  
Gross weight 7 Kg Net weight 3,5 Kg





## Spotlight



Ø 10 cm

6200



Ø 10 cm

6205 6210



Ø 10 cm

6215

### 6200

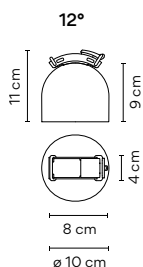

#### Finishes

- 11/ \_\_ Black (NCS S 8500-N)
- 24/ \_\_ Beige M1 (NCS S 2005-Y50R)
- 37/ \_\_ Terra Red (NCS S 4040-Y70R)
- 42/ \_\_ Blue M1 (NCS S 5010-B10G)
- 53/ \_\_ Green M1 (NCS S 6005-G80Y)

#### LED temperature colour

- /1 \_ 2700 K CRI >90 846 lm 107,09 lm/W
- /2 \_ 3000 K CRI >90 884 lm 111,9 lm/W
- /3 \_ 3500 K CRI >90 916 lm 115,95 lm/W

#### Control

- |   |          |
|---|----------|
| 6200 __ / _ 0<br>On/ Off  | 265,00 € |
| 6200 __ / _ F<br>Simultaneous line<br>DALI, 1-10V, Push, Casambi          | 295,00 € |
| 6200 __ / _ Z<br>Casambi integrated on each<br>individual luminaire (P2P) | 415,00 € |

#### Materials

Shade: Aluminum.  
Diffuser: Polycarbonate.

Light Source and electronics  
1 x LED 7,9 W 450 mA

#### Packaging

1 Box 0,193 x 0,161 x 0,148 m  
Vol 0,0046 m<sup>3</sup>  
Gross weight 0,719 Kg Net weight 0,51 Kg

LED IP20

Bi-volt Dimmer

### 6205

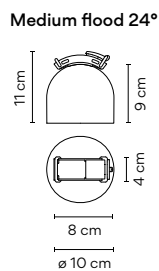

#### Finishes

- 11/ \_\_ Black (NCS S 8500-N)
- 24/ \_\_ Beige M1 (NCS S 2005-Y50R)
- 37/ \_\_ Terra Red (NCS S 4040-Y70R)
- 42/ \_\_ Blue M1 (NCS S 5010-B10G)
- 53/ \_\_ Green M1 (NCS S 6005-G80Y)

#### LED temperature colour

- /1 \_ 2700 K CRI >90 846 lm 107,09 lm/W
- /2 \_ 3000 K CRI >90 884 lm 111,9 lm/W
- /3 \_ 3500 K CRI >90 916 lm 115,95 lm/W

#### Control

- |   |          |
|---|----------|
| 6205 __ / _ 0<br>On/ Off  | 265,00 € |
| 6205 __ / _ F<br>Simultaneous line<br>DALI, 1-10V, Push, Casambi          | 295,00 € |
| 6205 __ / _ Z<br>Casambi integrated on each<br>individual luminaire (P2P) | 415,00 € |

#### Materials

Shade: Aluminum.  
Diffuser: Polycarbonate.

Light Source and electronics  
1 x LED 7,9 W 450 mA

#### Packaging

1 Box 0,193 x 0,161 x 0,148 m  
Vol 0,0046 m<sup>3</sup>  
Gross weight 0,719 Kg Net weight 0,51 Kg

LED IP20

Bi-volt Dimmer

# Luminaire types

It is not possible to order luminaires alone, you need to design your Plusminus on our website [vibia.com](http://vibia.com)

**6210**

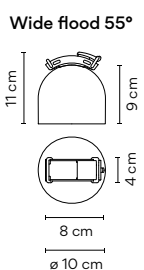

**Wide flood 55°**



**Finishes**

- **11/** \_ \_ Black (NCS S 8500-N)
- **24/** \_ \_ Beige M1 (NCS S 2005-Y50R)
- **37/** \_ \_ Terra Red (NCS S 4040-Y70R)
- **42/** \_ \_ Blue M1 (NCS S 5010-B10G)
- **53/** \_ \_ Green M1 (NCS S 6005-G80Y)

**LED temperature colour**

- /1** \_ 2700 K  CRI >90 846 lm 107,09 lm/W
- /2** \_ 3000 K  CRI >90 884 lm 111,9 lm/W
- /3** \_ 3500 K  CRI >90 916 lm 115,95 lm/W





**Control**

|   |                 |
|---|-----------------|
| <b>6210</b> _ _ / _ <b>0</b><br>On/ Off   | <b>265,00 €</b> |
| <b>6210</b> _ _ / _ <b>F</b><br>Simultaneous line<br>DALI, 1-10V, Push, Casambi       | <b>295,00 €</b> |
| <b>6210</b> _ _ / _ <b>Z</b><br>Casambi integrated on each individual luminaire (P2P) | <b>415,00 €</b> |

**Materials**  
Shade: Aluminum.  
Diffuser: Polycarbonate.

**Light Source and electronics**  
1 x LED 7,9 W 450 mA

**Packaging**  
1 Box 0,193 x 0,161 x 0,148 m  
Vol 0,0046 m<sup>3</sup>  
Gross weight 0,719 Kg Net weight 0,51 Kg

**LED**  **IP20**   

**Bi-volt** **Dimmer**

**6215**

**Directed diffusion lighting**

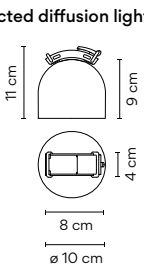

**Finishes**

- **11/** \_ \_ Black (NCS S 8500-N)
- **24/** \_ \_ Beige M1 (NCS S 2005-Y50R)
- **37/** \_ \_ Terra Red (NCS S 4040-Y70R)
- **42/** \_ \_ Blue M1 (NCS S 5010-B10G)
- **53/** \_ \_ Green M1 (NCS S 6005-G80Y)

**LED temperature colour**

- /1** \_ 2700 K  CRI >90 491 lm 116,9 lm/W
- /2** \_ 3000 K  CRI >90 513 lm 122,14 lm/W
- /3** \_ 3500 K  CRI >90 532 lm 126,67 lm/W



**Control**

|   |                 |
|---|-----------------|
| <b>6215</b> _ _ / _ <b>0</b><br>On/ Off   | <b>265,00 €</b> |
| <b>6215</b> _ _ / _ <b>F</b><br>Simultaneous line<br>DALI, 1-10V, Push, Casambi       | <b>295,00 €</b> |
| <b>6215</b> _ _ / _ <b>Z</b><br>Casambi integrated on each individual luminaire (P2P) | <b>415,00 €</b> |

**Materials**  
Shade: Aluminum.  
Diffuser: Polycarbonate.

**Light Source and electronics**  
1 x LED 4,2 W 250 mA

**Packaging**  
1 Box 0,193 x 0,161 x 0,148 m  
Vol 0,0046 m<sup>3</sup>  
Gross weight 0,719 Kg Net weight 0,51 Kg

**LED**  **IP20**   

**Bi-volt** **Dimmer**

Accent lighting



Directed diffusion lighting

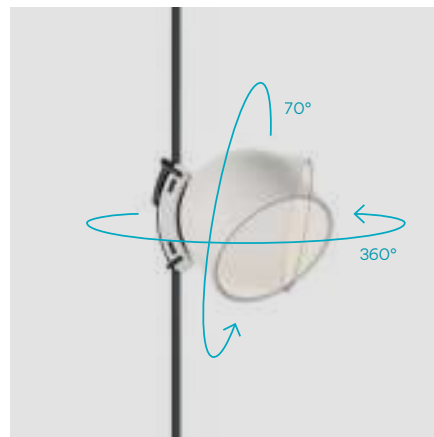

## Linear diffuser



6250

6255

### 6250



| Finishes                                | LED temperature colour                     | Control   |          |
|---|--|---|----------|
| ● 11/ __ Black<br>(NCS S 8500-N)        | /1 _ 2700 K<br>CRI >90 2544 lm 123,5 lm/W  | 6250 __ / _ O<br>On/ Off  | 435,00 € |
| ● 24/ __ Beige M1<br>(NCS S 2005-Y50R)  | /2 _ 3000 K<br>CRI >90 2628 lm 127,57 lm/W | 6250 __ / _ F<br>Simultaneous line<br>DALI, 1-10V, Push, Casambi          | 465,00 € |
| ● 37/ __ Terra Red<br>(NCS S 4040-Y70R) | /3 _ 3500 K<br>CRI >90 2712 lm 131,65 lm/W | 6250 __ / _ Z<br>Casambi integrated on each<br>individual luminaire (P2P) | 585,00 € |
| ● 42/ __ Blue M1<br>(NCS S 5010-B10G)   |  |   |          |
| ● 53/ __ Green M1<br>(NCS S 6005-G80Y)  |  |   |          |

#### Materials

Shade: Aluminum.  
Diffuser: Polycarbonate.

#### Light Source and electronics

1 x LED STRIP 20,6 W 24 V

#### Packaging

1 Box 0,06 x 0,06 x 1,25 m  
Vol 0,0057 m<sup>3</sup>  
Gross weight 1,5 Kg Net weight 0,72 Kg



### 6255



| Finishes                                | LED temperature colour                     | Control   |          |
|---|--|---|----------|
| ● 11/ __ Black<br>(NCS S 8500-N)        | /1 _ 2700 K<br>CRI >90 5088 lm 123,5 lm/W  | 6255 __ / _ O<br>On/ Off  | 640,00 € |
| ● 24/ __ Beige M1<br>(NCS S 2005-Y50R)  | /2 _ 3000 K<br>CRI >90 5256 lm 127,57 lm/W | 6255 __ / _ F<br>Simultaneous line<br>DALI, 1-10V, Push, Casambi          | 670,00 € |
| ● 37/ __ Terra Red<br>(NCS S 4040-Y70R) | /3 _ 3500 K<br>CRI >90 5424 lm 131,65 lm/W | 6255 __ / _ Z<br>Casambi integrated on each<br>individual luminaire (P2P) | 790,00 € |
| ● 42/ __ Blue M1<br>(NCS S 5010-B10G)   |  |   |          |
| ● 53/ __ Green M1<br>(NCS S 6005-G80Y)  |  |   |          |

#### Materials

Shade: Aluminum.  
Diffuser: Polycarbonate.

#### Light Source and electronics

1 x LED STRIP 41,3 W 24 V

#### Packaging

1 Box 0,06 x 0,06 x 2,24 m  
Vol 0,0103 m<sup>3</sup>  
Gross weight 2 Kg Net weight 1,45 Kg



Linear Low UGR  
High-Comfort

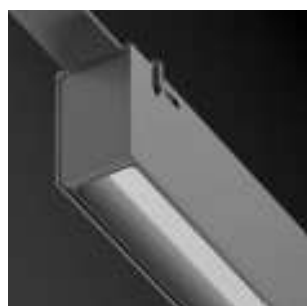
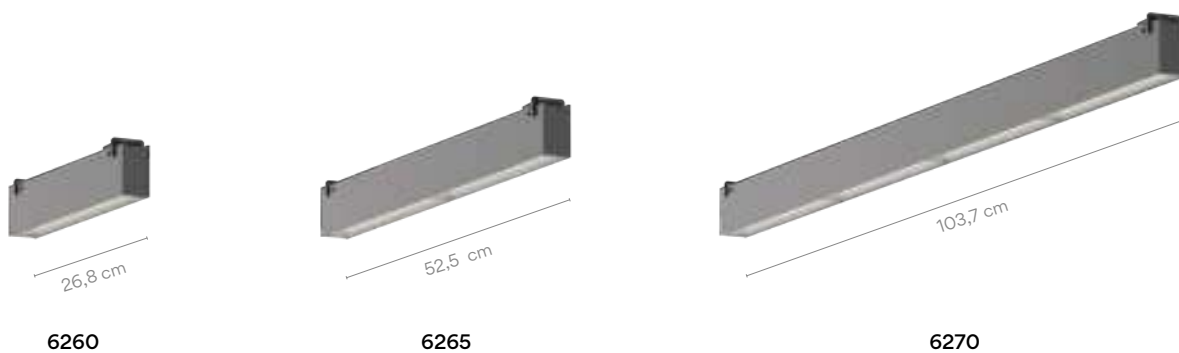

6260

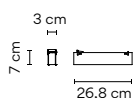

- Finishes**
- **11/** \_ \_ Black  
(NCS S 8500-N)
  - **24/** \_ \_ Beige M1  
(NCS S 2005-Y50R)
  - **37/** \_ \_ Terra Red  
(NCS S 4040-Y70R)
  - **42/** \_ \_ Blue M1  
(NCS S 5010-B10G)
  - **53/** \_ \_ Green M1  
(NCS S 6005-G80Y)

- LED temperature colour**
- /1** \_ 2700 K CRI >90 1281 lm 124,37 lm/W
  - /2** \_ 3000 K CRI >90 1323 lm 128,45 lm/W
  - /3** \_ 3500 K CRI >90 1366 lm 132,62 lm/W

- Control**
- |  |                 |
|--|-----------------|
| <b>6260</b> _ _ / _ <b>0</b><br>On/ Off  | <b>390,00 €</b> |
| <b>6260</b> _ _ / _ <b>F</b><br>Simultaneous line<br>DALI, 1-10V, Push, Casambi          | <b>420,00 €</b> |
| <b>6260</b> _ _ / _ <b>Z</b><br>Casambi integrated on each<br>individual luminaire (P2P) | <b>540,00 €</b> |

**Materials**  
Shade: Aluminum.  
Diffuser: PET.

**Light Source and electronics**  
1 x LED STRIP 20,6 W 24 V

**Packaging**  
1 Box 0,08 x 0,11 x 0,32 m  
Vol 0,0028 m³  
Gross weight 0,8 Kg Net weight 0,41 Kg

**Notes**  
UGR <19



6265

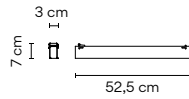

| Finishes                                | LED temperature colour                    | Control   |          |
|---|---|---|----------|
| ● 11/ __ Black<br>(NCS S 8500-N)        | /1_ 2700 K<br>CRI >90 2562 lm 124,37 lm/W | 6265 __ / _ 0<br>On/ Off  | 550,00 € |
| ● 24/ __ Beige M1<br>(NCS S 2005-Y50R)  | /2_ 3000 K<br>CRI >90 2647 lm 128,5 lm/W  | 6265 __ / _ F<br>Simultaneous line<br>DALI, 1-10V, Push, Casambi          | 580,00 € |
| ● 37/ __ Terra Red<br>(NCS S 4040-Y70R) | /3_ 3500 K<br>CRI >90 2731 lm 132,57 lm/W | 6265 __ / _ Z<br>Casambi integrated on each<br>individual luminaire (P2P) | 700,00 € |
| ● 42/ __ Blue M1<br>(NCS S 5010-B10G)   |   |   |          |
| ● 53/ __ Green M1<br>(NCS S 6005-G80Y)  |   |   |          |

Materials

Shade: Aluminum.  
Diffuser: PET.

Light Source and electronics  
1 x LED STRIP 20,6 W 24 V

Packaging

1 Box 0,08 x 0,11 x 0,57 m  
Vol 0,0050 m<sup>3</sup>  
Gross weight 1,5 Kg Net weight 0,89 Kg

Notes

UGR <19



6270

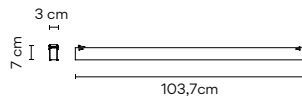

| Finishes                                | LED temperature colour                    | Control   |            |
|---|---|---|------------|
| ● 11/ __ Black<br>(NCS S 8500-N)        | /1_ 2700 K<br>CRI >90 5124 lm 124,07 lm/W | 6270 __ / _ 0<br>On/ Off  | 875,00 €   |
| ● 24/ __ Beige M1<br>(NCS S 2005-Y50R)  | /2_ 3000 K<br>CRI >90 5293 lm 128,16 lm/W | 6270 __ / _ F<br>Simultaneous line<br>DALI, 1-10V, Push, Casambi          | 905,00 €   |
| ● 37/ __ Terra Red<br>(NCS S 4040-Y70R) | /3_ 3500 K<br>CRI >90 5462 lm 132,25 lm/W | 6270 __ / _ Z<br>Casambi integrated on each<br>individual luminaire (P2P) | 1.025,00 € |
| ● 42/ __ Blue M1<br>(NCS S 5010-B10G)   |   |   |            |
| ● 53/ __ Green M1<br>(NCS S 6005-G80Y)  |   |   |            |

Materials

Shade: Aluminum.  
Diffuser: PET.

Light Source and electronics  
1 x LED STRIP 41,3 W 24 V

Packaging

1 Box 0,08 x 0,11 x 1,10 m  
Vol 0,0096 m<sup>3</sup>  
Gross weight 2,5 Kg Net weight 1,5 Kg

Notes

UGR <19



Linear Low UGR  
High-Efficiency



6275



6280

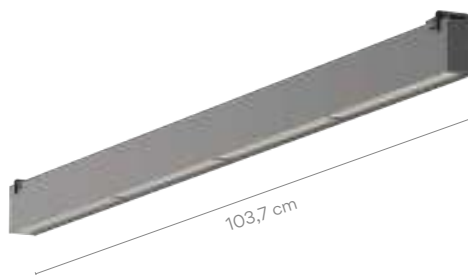

6285



6275

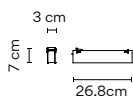

- Finishes**
- **11/** \_ \_ Black  
(NCS S 8500-N)
  - **24/** \_ \_ Beige M1  
(NCS S 2005-Y50R)
  - **37/** \_ \_ Terra Red  
(NCS S 4040-Y70R)
  - **42/** \_ \_ Blue M1  
(NCS S 5010-B10G)
  - **53/** \_ \_ Green M1  
(NCS S 6005-G80Y)

- LED temperature colour**
- /1** \_ 2700 K CRI >90 1281 lm 124,37 lm/W
  - /2** \_ 3000 K CRI >90 1323 lm 128,45 lm/W
  - /3** \_ 3500 K CRI >90 1366 lm 132,62 lm/W

- Control**
- |  |                 |
|--|-----------------|
| <b>6275</b> _ _ / _ <b>O</b><br>On/ Off  | <b>345,00 €</b> |
| <b>6275</b> _ _ / _ <b>F</b><br>Simultaneous line<br>DALI, 1-10V, Push, Casambi          | <b>375,00 €</b> |
| <b>6275</b> _ _ / _ <b>Z</b><br>Casambi integrated on each<br>individual luminaire (P2P) | <b>495,00 €</b> |

**Materials**  
Shade: Aluminum.

**Light Source and electronics**  
1 x LED STRIP 10,3 W 24 V

**Packaging**  
1 Box 0,08 x 0,11 x 0,32 m  
Vol 0,0028 m<sup>3</sup>  
Gross weight 0,8 Kg Net weight 0,41 Kg

**Notes**  
UGR <19



6280

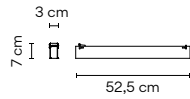

| Finishes                                | LED temperature colour                    | Control   |          |
|---|---|---|----------|
| ● 11/ __ Black<br>(NCS S 8500-N)        | /1_ 2700 K<br>CRI >90 2562 lm 124,37 lm/W | 6280 __ / _ 0<br>On/ Off  | 450,00 € |
| ● 24/ __ Beige M1<br>(NCS S 2005-Y50R)  | /2_ 3000 K<br>CRI >90 2647 lm 128,5 lm/W  | 6280 __ / _ F<br>Simultaneous line<br>DALI, 1-10V, Push, Casambi          | 480,00 € |
| ● 37/ __ Terra Red<br>(NCS S 4040-Y70R) | /3_ 3500 K<br>CRI >90 2731 lm 132,57 lm/W | 6280 __ / _ Z<br>Casambi integrated on each<br>individual luminaire (P2P) | 600,00 € |
| ● 42/ __ Blue M1<br>(NCS S 5010-B10G)   |   |   |          |
| ● 53/ __ Green M1<br>(NCS S 6005-G80Y)  |   |   |          |

Materials

Shade: Aluminum.

Light Source and electronics

1 x LED STRIP 20,6 W 24 V

Packaging

1 Box 0,08 x 0,11 x 0,57 m

Vol 0,0050 m<sup>3</sup>

Gross weight 1,5 Kg Net weight 0,89 Kg

Notes

UGR <19



6285

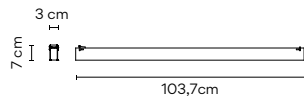

| Finishes                                | LED temperature colour                    | Control   |          |
|---|---|---|----------|
| ● 11/ __ Black<br>(NCS S 8500-N)        | /1_ 2700 K<br>CRI >90 5124 lm 124,07 lm/W | 6285 __ / _ 0<br>On/ Off  | 685,00 € |
| ● 24/ __ Beige M1<br>(NCS S 2005-Y50R)  | /2_ 3000 K<br>CRI >90 5293 lm 128,16 lm/W | 6285 __ / _ F<br>Simultaneous line<br>DALI, 1-10V, Push, Casambi          | 715,00 € |
| ● 37/ __ Terra Red<br>(NCS S 4040-Y70R) | /3_ 3500 K<br>CRI >90 5462 lm 132,25 lm/W | 6285 __ / _ Z<br>Casambi integrated on each<br>individual luminaire (P2P) | 835,00 € |
| ● 42/ __ Blue M1<br>(NCS S 5010-B10G)   |   |   |          |
| ● 53/ __ Green M1<br>(NCS S 6005-G80Y)  |   |   |          |

Materials

Shade: Aluminum.

Light Source and electronics

1 x LED STRIP 41,3 W 24V

Packaging

1 Box 0,08 x 0,11 x 1,102 m

Vol 0,0096 m<sup>3</sup>

Gross weight 2,5 Kg Net weight 1,5 Kg

Notes

UGR <19



# Accessories Toolbox

Thought out to the smallest detail.  
Receive your personalised accessories  
toolbox for a quick and easy installation.





# Installation accessories

You will receive a personalised accessories toolbox per every composition made at vibia.com. The Toolbox includes some extra units for on-site adjustments.

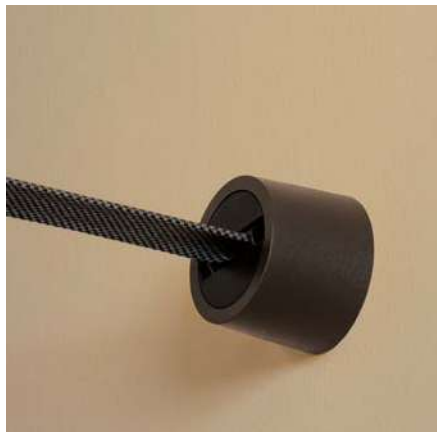

## Belt terminations options

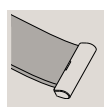

**B3**  
Belt End Cap

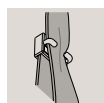

**B4**  
Double End Cap

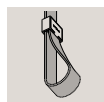

**B5**  
Pendant End Cap

## Fasten accessories options



**F1**  
Circular Ratchet

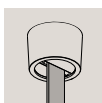

**F2**  
Circular Anchor

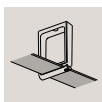

**F3**  
Belt Support

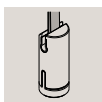

**F4**  
Counterweight

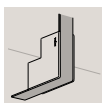

**F5**  
Corner Support



**F6**  
Freestyle Bar  
2 m. bar length  
5 m. maximum tensor cable

## Tension clips options



**T1**  
Suspension Clip



**T2**  
V-Tension Clip

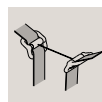

**T3**  
Parallel Tension Clip S



**T4**  
Parallel Tension Clip M



**T5**  
Cable End Cap



**T6**  
Pendant Cable S



**T7**  
Pendant Cable M

### Materials

Counterweight: Cast iron

### Finishes

**11** Black (NCS S 0300-N)

# Electrical connection options

Choose your preferred installation option according to your needs.



Surface



Built-in



Remote  
Built-in



Surface



Plug



Optional wire  
connector

## Dimming control options

Choose your preferred installation option according to your needs.

### Dimming Control

### Electrical Connection

|   | Surface    | Built-in   | Remote     | Plug    |
|---|------------|------------|------------|---------|
|   | 25 - 240 W | 25 - 240 W | 25 - 240 W | Max 60W |
| On/ Off   | ✓          | ✓          | ✓          | ✓       |
| Push Switch   | —          | —          | —          | ✓       |
| Push Simultaneous                                     | ✓          | ✓          | ✓          | —       |
| 1-10V Simultaneous                                    | ✓          | ✓          | ✓          | —       |
| DALI Simultaneous                                     | ✓          | ✓          | ✓          | —       |
| Casambi Simultaneous                                  | ✓          | ✓          | ✓          | ✓       |
| Casambi integrated on each individual luminaire (P2P) | ✓          | ✓          | ✓          | ✓       |

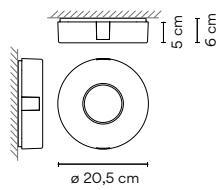

**Surface Canopy S**  
E1 Ø 205 mm.  
**Wattage options:**  
< 60W.

**Driver** Constant Voltage 42V.  
90-305 VAC. 100~240V. 50/60Hz.

**Dimming options:**  
On/ Off.  
Simultaneous line DALI / 1-10V / Push / Casambi.  
Casambi integrated on each individual luminaire (P2P).

**Body:** ABS.  
Net weight 0,9 Kg.

**11** Black  
(NCS S 8500-N)

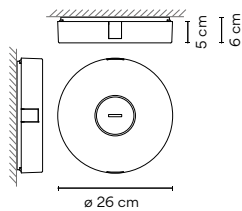

**Surface Canopy M**  
E2 Ø 260 mm.  
**Wattage options:**  
>60W.  
<240W.

**Driver** Constant Voltage 42V.  
90-305 VAC. 100~240V. 50/60Hz.

**Dimming options:**  
On/ Off.  
Simultaneous line DALI / 1-10V / Push / Casambi.  
Casambi integrated on each individual luminaire (P2P).

**Body:** ABS.  
Net weight 1,8 Kg.

**11** Black  
(NCS S 8500-N)

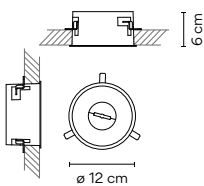

**Built-in Canopy**  
E3 Ø 120 mm.  
**Wattage options:**  
>25W.  
<240W.

**Driver** Constant Voltage 42V.  
90-305 VAC. 100~240V. 50/60Hz.

**Dimming options:**  
On/ Off.  
Simultaneous line DALI / 1-10V / Push / Casambi.  
Casambi integrated on each individual luminaire (P2P).

**Body:** ABS.  
Net weight 1,08 - 1,860 Kg.

**11** Black  
(NCS S 8500-N)

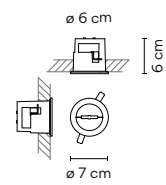
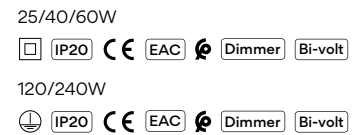

**Remote Built-in Canopy**  
E4 Ø 60 mm.  
**Wattage options:**  
>25W.  
<240W.

**Driver** Constant Voltage 42V.  
90-305 VAC. 100~240V. 50/60Hz.

**Dimming options:**  
On/ Off.  
Simultaneous line DALI / 1-10V / Push / Casambi.  
Casambi integrated on each individual luminaire (P2P).

**Body:** ABS.  
Net weight 0,87 - 1,65 Kg.

**11** Black  
(NCS S 8500-N)

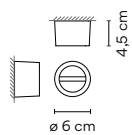
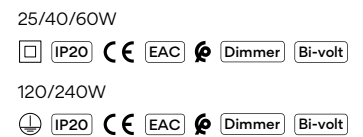

**Remote Surface Canopy**  
E5 Ø 60 mm.  
**Wattage options:**  
>25W.  
<240W.

**Driver** Constant Voltage 42V.  
90-305 VAC. 100~240V. 50/60Hz.

**Dimming options:**  
On/ Off.  
Simultaneous line DALI / 1-10V / Push / Casambi.  
Casambi integrated on each individual luminaire (P2P).

**Body:** Aluminum.  
Net weight 0,95 - 1,73 Kg.

**11** Black  
(NCS S 8500-N)

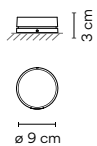
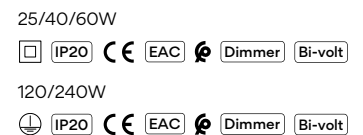

**Plug-in Floor Switch**  
E6 Ø 90 mm.  
**Wattage options:**  
< 60W.

**Driver** Constant Voltage 42V.  
90-305 VAC. 100~240V. 50/60Hz.

**Dimming options:**  
On/ Off.  
Push.  
Casambi P2P.

**Body:** ABS.

**11** Black  
(NCS S 8500-N)

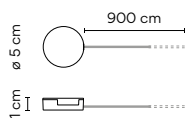

**Wire Connector**  
E8 Ø 3,1 mm.  
**Wattage options:**  
< 60W.  
**Wire connector**  
E8 Ø 5,8 mm.  
**Wattage options:**  
< 60W.  
<240W.

**Driver** Constant Voltage 42V.  
90-305 VAC. 50/60Hz.

**Body:** ABS.

**11** Black  
(NCS S 8500-N)

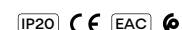

# Belt

Maximum 60 metres per electrical connection, belt length personalised for each composition on [www.vibia.com](http://www.vibia.com)

---

|                                     |             |   |
|-------------------------------------|-------------|---|
| <b>Finishes</b>                     | <b>Belt</b> | <b>Fire Hazard Testing. GW-960.</b>   |
| Black<br>Terra Red<br>Blue<br>Beige | Polyester   | fulfills the requirements of:<br>standards EN 60695-2-10:2013;<br>EN 60695-2-11:2015;<br>EN 60695-2-12:2011 / A1:2014 |

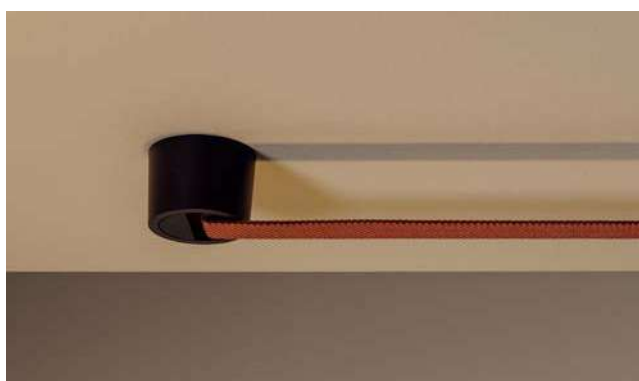
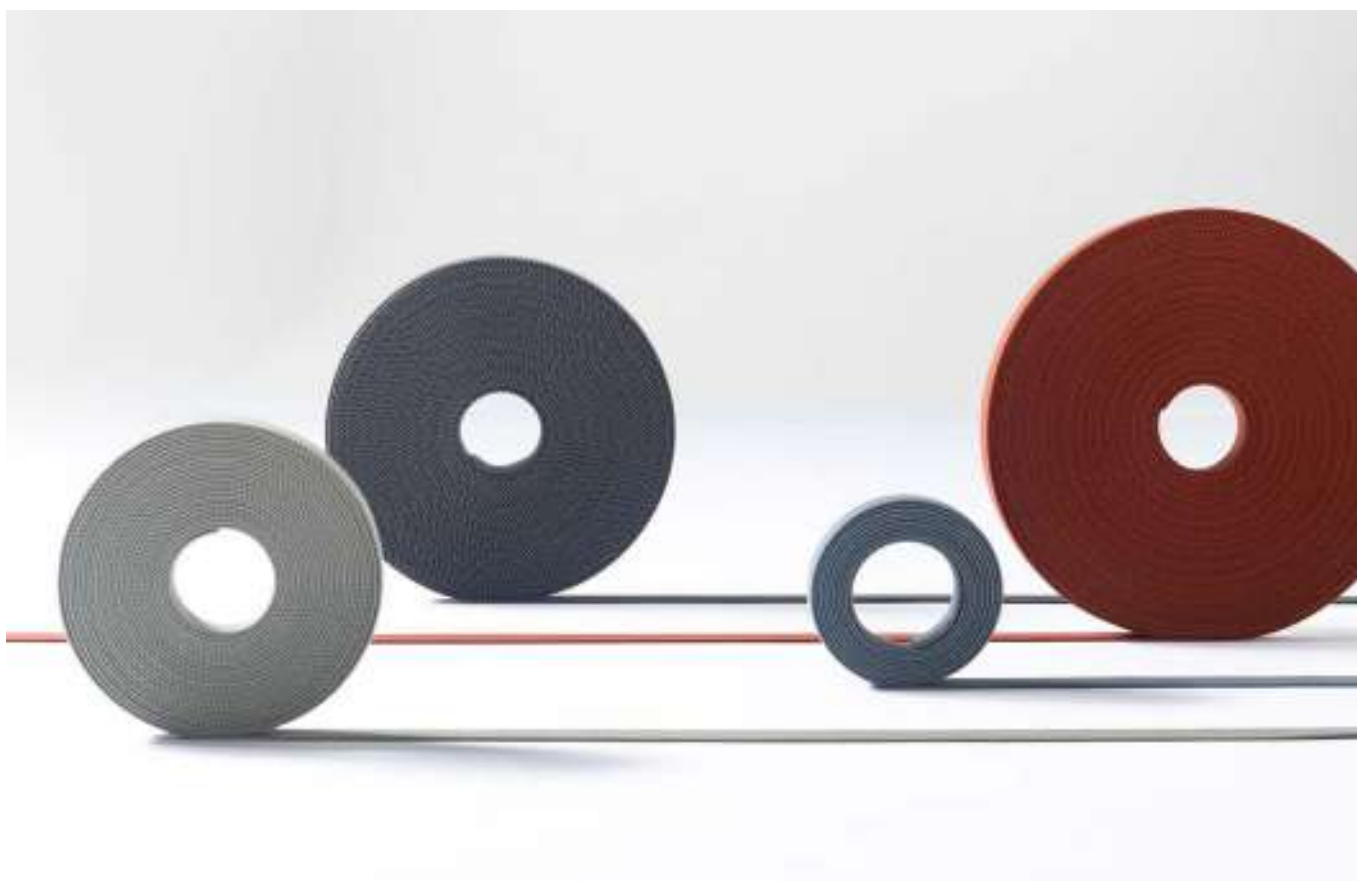

The distance of the belt from the wall or the ceiling, when installed in parallel, is always 4,5 cm.

# Belt terminations

Belt terminations can be adjusted during the installation process according to your preference.



# Composition examples for orientative prices

The final price of the composition depends on the number of luminaires, belt length, dimming control and the electrical connection type chosen.

## Composition examples for orientative prices

---

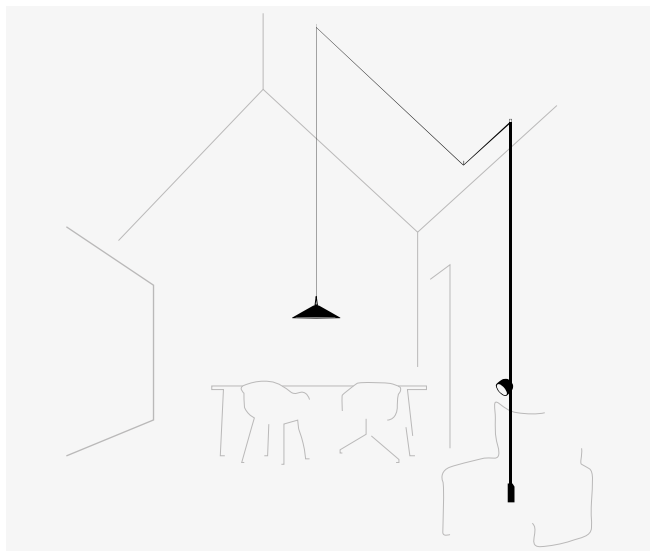

Sketch composed by one composition.

2 luminaires: Cone 6240, Spotlight 6215.

From 1.570,00 €

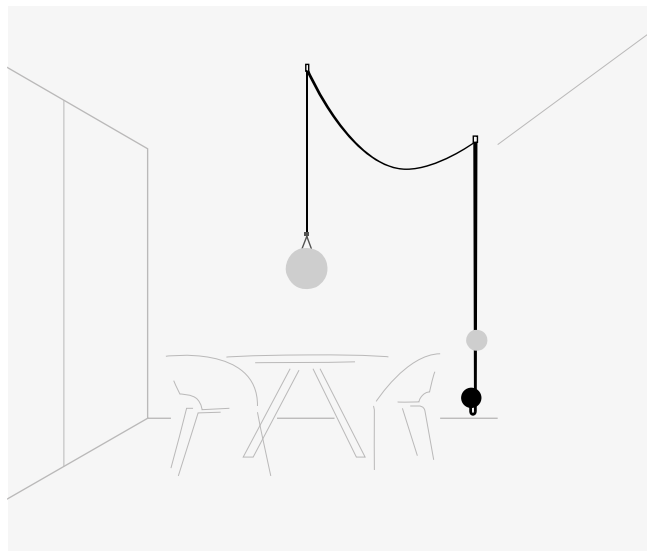

Sketch composed by one composition.

2 luminaires: Sphere 6230, Sphere 6235.

From 1.205,00 €

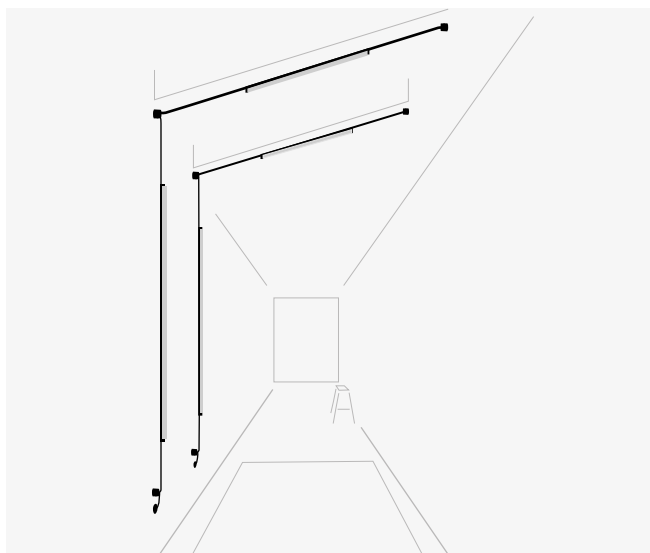

Sketch composed by two identical compositions.

2 luminaires: Linear Diffuser 6250, Linear Diffuser 6255.

From 1.875,00 € / each composition

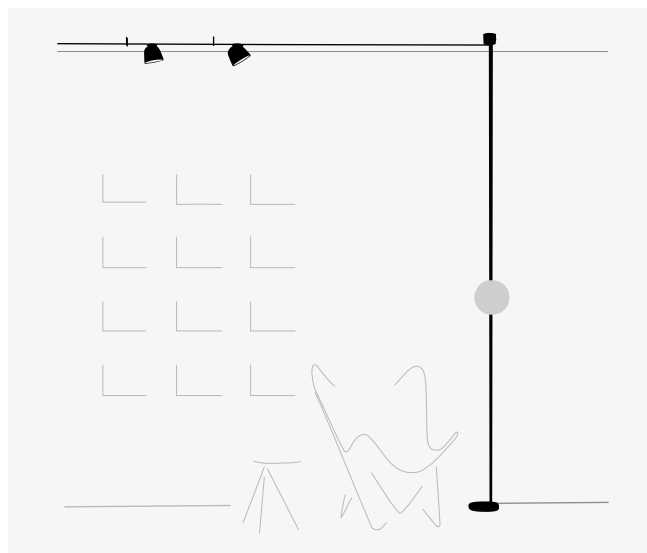

Sketch composed by one composition.

3 luminaires: Spotlight 6205 x 2, Sphere 6230.

From 1.590,00 €



Sketch composed by one composition.

1 luminaire: Sphere 6230.

From 720,00 €

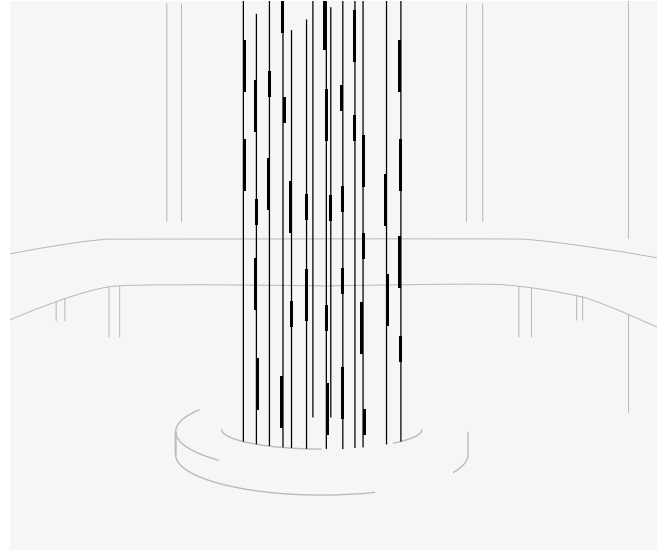

Sketch composed by several compositions.

3 luminaires: Linear Diffuser 6255.

From 2.645,00 € / each composition

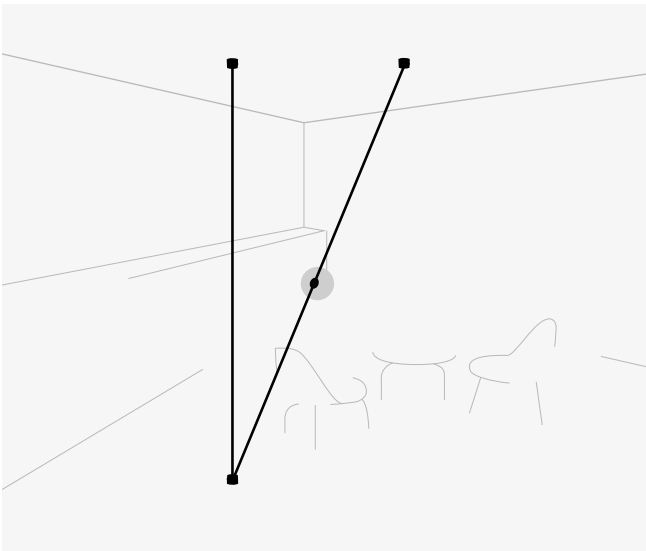

Sketch composed by one composition.

1 luminaire: Sphere 6230.

From 980,00 €

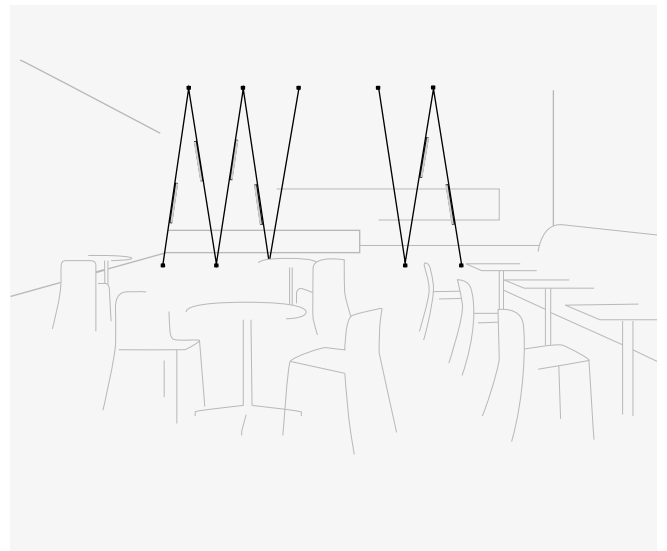

Sketch composed by two compositions.

2 luminaires: Linear Diffuser 6250.

From 1.800,00 € / small composition

## Composition examples for orientative prices

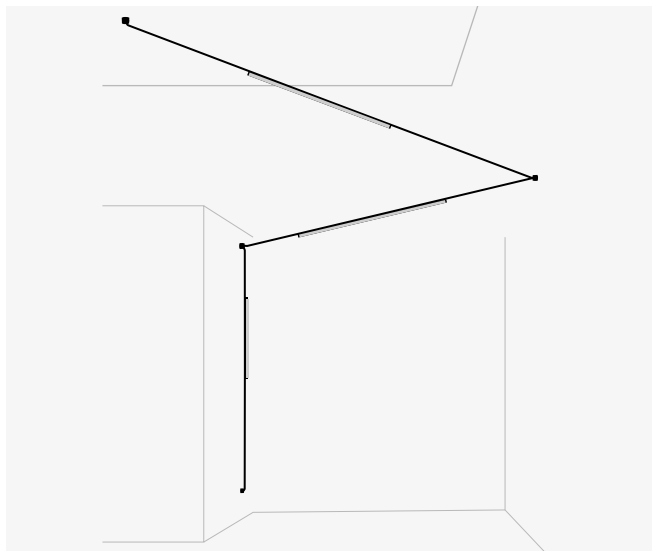

Sketch composed by one composition.

3 luminaires: Linear Diffuser 6250, Linear Diffuser 6255 x 2.

From 2.685,00 €

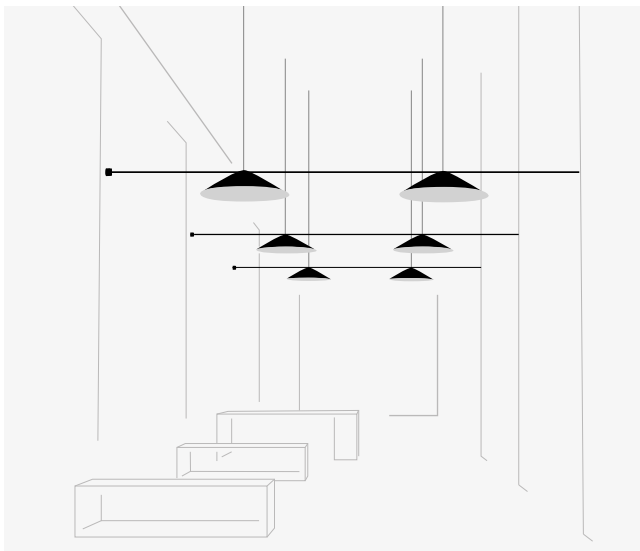

Sketch composed by three identical compositions.

2 luminaires: Cone 6245 x 2.

From 2.260,00 € / each composition

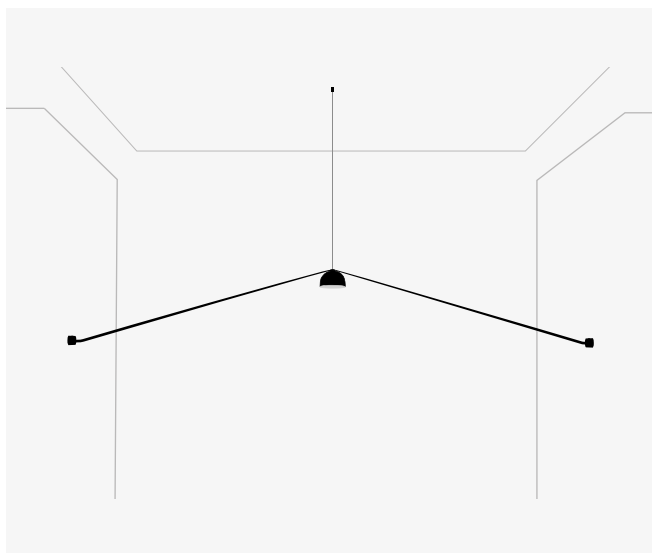

Sketch composed by one composition.

1 luminaire: Semisphere 6225.

From 965,00 €

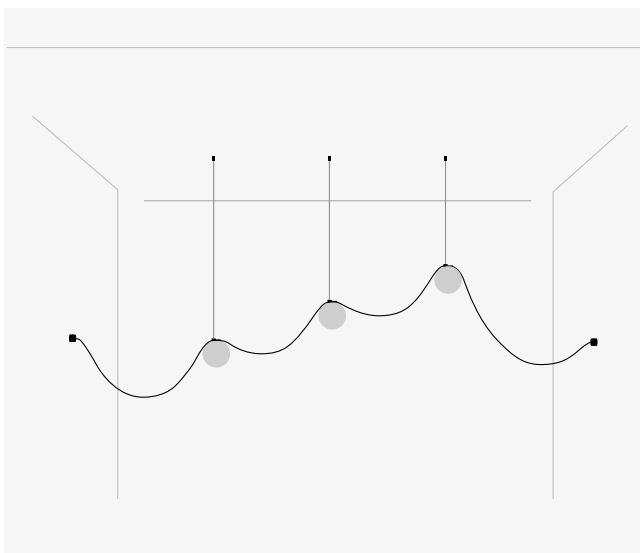

Sketch composed by one composition.

3 luminaires: Sphere 6230 x 3.

From 1.490,00 €



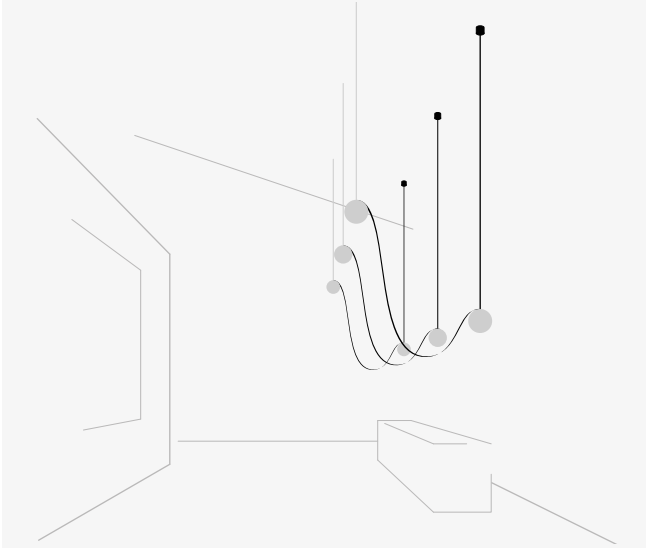

Sketch composed by three identical compositions.

2 luminaires: Sphere 6235 x 2.

From 1.175,00 € / each composition

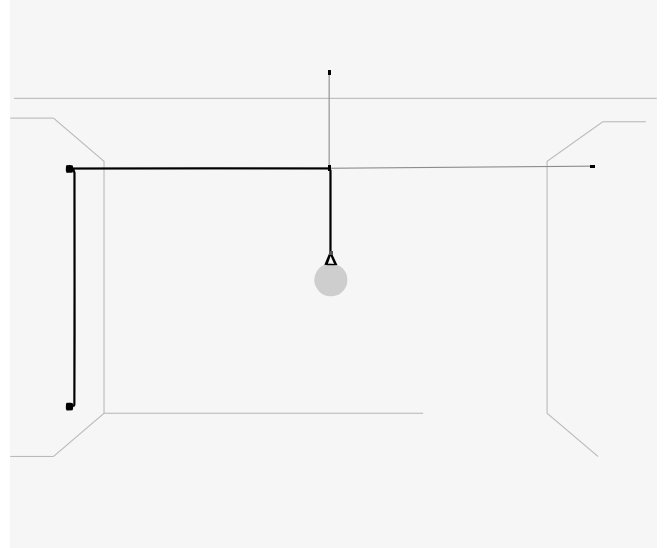

Sketch composed by one composition.

1 luminaire: Sphere 6235.

From 970,00 €

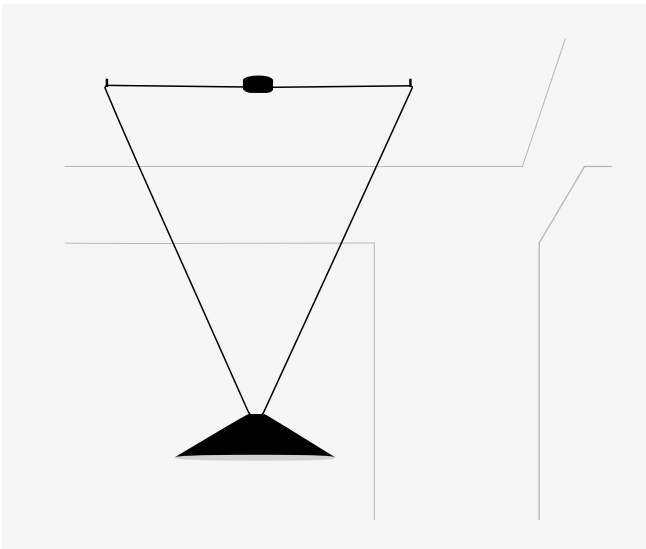

Sketch composed by one composition.

1 luminaire: Cone 6245.

From 1.355,00 €

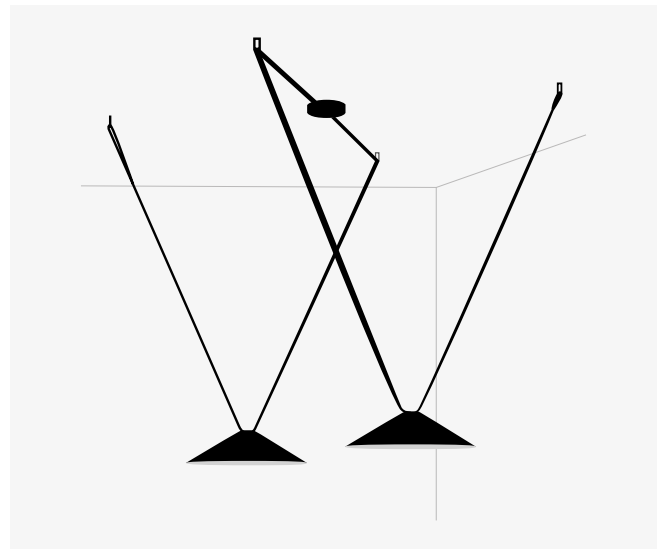

Sketch composed by one composition.

2 luminaires: Cone 6240 x 2.

From 1.880,00 €

## Composition examples for orientative prices

---

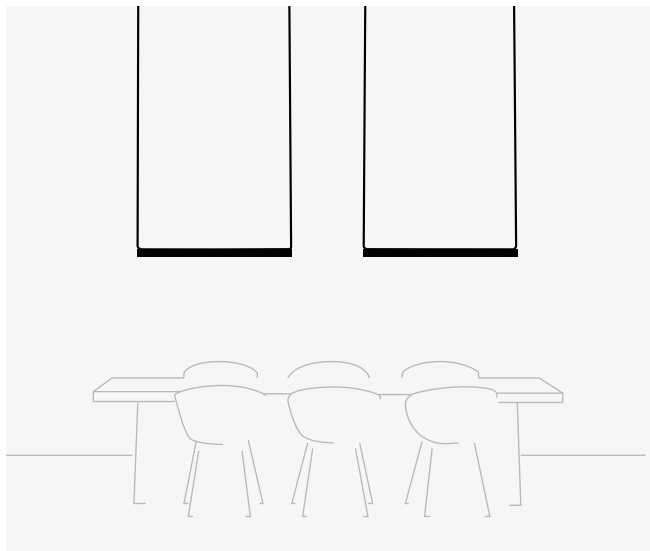

Sketch composed by one composition.

2 luminaires: Linear Low UGR High-Comfort 6270 x 2.

From 2.505,00 €



Sketch composed by one composition.

5 luminaires: Sphere 6230 x 5.

From 2.210,00 €

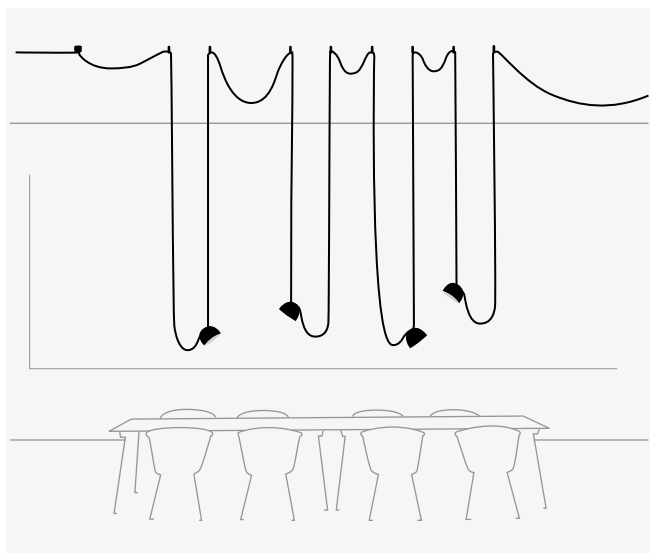

Sketch composed by one composition.

4 luminaires: Semisphere 6220 x 4.

From 2.045,00 €

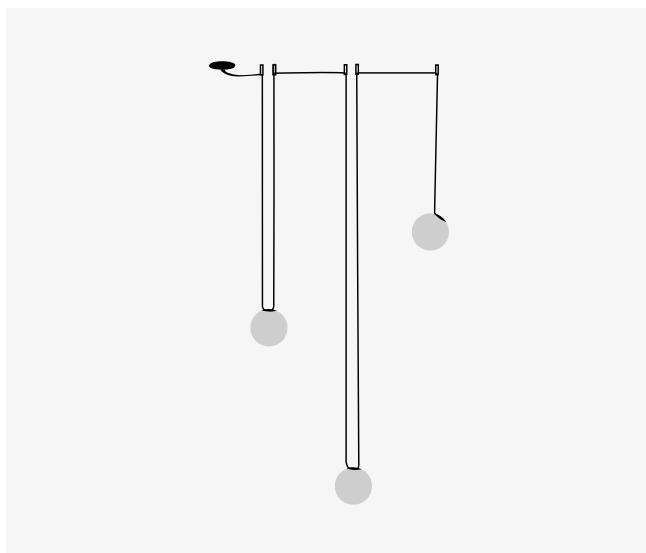

Sketch composed by one composition.

3 luminaires: Sphere 6230 x 3.

From 1.485,00 €

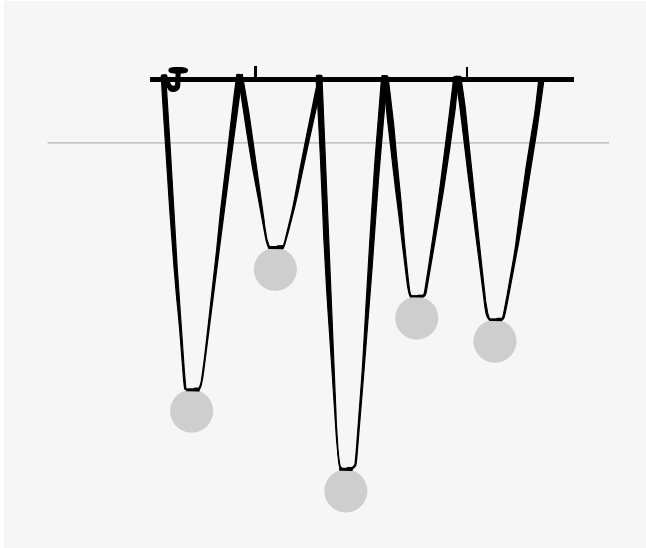

Sketch composed by one composition.

5 luminaires: Sphere 6230 x 5.

From 2.415,00 €

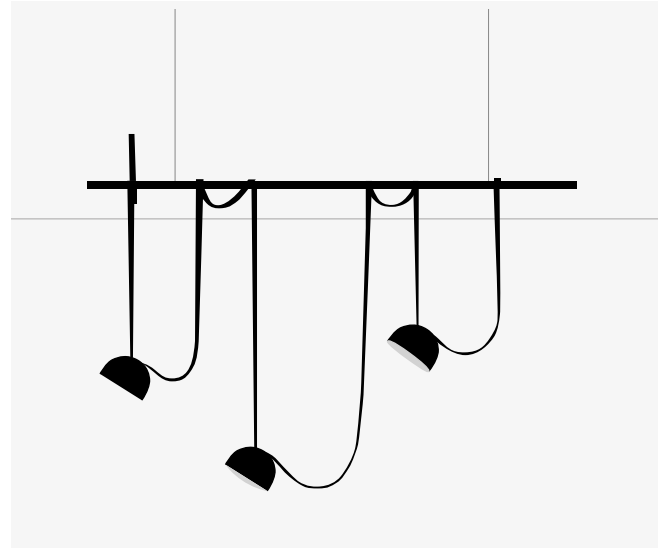

Sketch composed by one composition.

3 luminaires: Semisphere 6220 x 3.

From 1.870,00 €

Each project is unique.  
Visit [vibia.com](http://vibia.com) and chose among  
multiple compositions designed  
and adapted to your project needs.

Personalise your own Plusminus composition  
quick and easy at [vibia.com](http://vibia.com)

# Kontur

Design by Sebastian Herkner

Providing a framework for light, the Kontur collection serves as an elegant stage setting for the linear light source it contains. Its minimalist black frame pairs with different diffusers or reflectors in a poetic balance, creating myriad lighting ambiances.

## Wall



20 x 92 cm

**6414**

20 x 122 cm

**6416**

20 x 162 cm

**6418**

19 x 92 cm

**6444**

19 x 122 cm

**6446**

### 6414

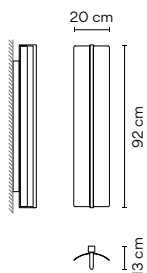

#### Finishes

- 11/ \_ \_ Black (NCS S 8500-N)

#### LED temperature colour

- /7 \_ 2200 K CRI >90 2041,15 lm 97,2 lm/W
- /1 \_ 2700 K CRI >90 2381,3 lm 113 lm/W
- /2 \_ 3000 K CRI >90 2381,3 lm 113 lm/W

#### Control

- 6414 \_ \_ / \_ 1 **760,00 €**  
DALI
- 6414 \_ \_ / \_ 3 **720,00 €**  
1-10V
- 6414 \_ \_ / \_ 5 **760,00 €**  
Push
- 6414 \_ \_ / \_ Z **840,00 €**  
Casambi

#### Materials

Concave shade: Aluminum. Diffuser: Polycarbonate.  
Structures: Steel. Canopy: Aluminum.

#### Light Source and electronics

1 x LED STRIP 20,8 W 750 mA  
Constant Current 750 mA  
90-305V 50/60Hz

#### Packaging

1 Box 0,30 x 0,30 x 1,05 m  
Vol 0,095 m<sup>3</sup>  
Gross weight 5,5 Kg Net weight 3,5 Kg



### 6416

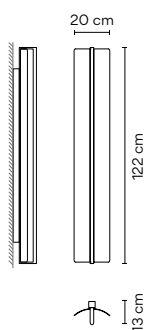

#### Finishes

- 11/ \_ \_ Black (NCS S 8500-N)

#### LED temperature colour

- /7 \_ 2200 K CRI >90 2703,32 lm 96,9 lm/W
- /1 \_ 2700 K CRI >90 3153,9 lm 113 lm/W
- /2 \_ 3000 K CRI >90 3153,0 lm 113 lm/W

#### Control

- 6416 \_ \_ / \_ 1 **835,00 €**  
DALI
- 6416 \_ \_ / \_ 3 **795,00 €**  
1-10V
- 6416 \_ \_ / \_ 5 **835,00 €**  
Push
- 6416 \_ \_ / \_ Z **915,00 €**  
Casambi

#### Materials

Concave shade: Aluminum. Diffuser: Polycarbonate.  
Structures: Steel. Canopy: Aluminum.

#### Light Source and electronics

1 x LED STRIP 27,9 W 750 mA  
Constant Current 750 mA  
90-305V 50/60Hz

#### Packaging

1 Box 0,30 x 0,30 x 1,35 m  
Vol 0,122 m<sup>3</sup>  
Gross weight 5,8 Kg Net weight 3,8 Kg



6418

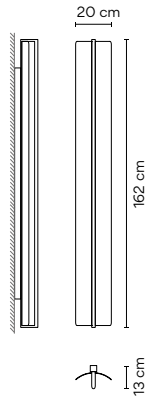

|  |   |   |
|--|---|---|
| <b>Finishes</b><br>● 11/ _ _ Black<br>(NCS S 8500-N)   | <b>LED temperature colour</b><br>/7 2200 K <b>F</b><br>CRI >90 3604,42 lm 96,9 lm/W<br>/1 2700 K <b>E</b><br>CRI >90 4205,2 lm 113 lm/W<br>/2 3000 K <b>F</b><br>CRI >90 4205,2 lm 113 lm/W | <b>Control</b><br>6418 _ _ / _ 1 <span style="float: right;">965,00 €</span><br>DALI  |
|  |   | 6418 _ _ / _ 3 <span style="float: right;">915,00 €</span><br>1-10V   |
|  |   | 6418 _ _ / _ 5 <span style="float: right;">965,00 €</span><br>Push<br>6418 _ _ / _ Z <span style="float: right;">1.035,00 €</span><br>Casambi |
| <b>Materials</b><br>Concave shade: Aluminum. Diffuser: Polycarbonate.<br>Structures: Steel. Canopy: Aluminum.    |   | <b>Packaging</b><br>1 Box 0,30 x 0,30 x 0,175 m<br>Vol 0,1580 m <sup>3</sup><br>Gross weight 6,5 Kg Net weight 4 Kg                           |
| <b>Light Source and electronics</b><br>1 x LED STRIP 37,2 W 750 mA<br>Constant Current 750 mA<br>90-305V 50/60Hz |   | <br>  |

6444

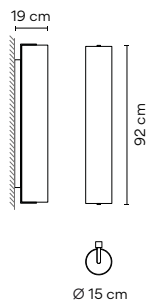

|  |  |   |
|--|--|---|
| <b>Finishes</b><br>● 11/ _ _ Black<br>(NCS S 8500-N)   | <b>LED temperature colour</b><br>/7 2200 K <b>F</b><br>CRI >90 2041,15 lm 98,1 lm/W<br>/1 2700 K <b>E</b><br>CRI >90 2381,3 lm 114 lm/W<br>/2 3000 K <b>F</b><br>CRI >90 2381,3 lm 114 lm/W<br>/3 3500 K <b>E</b><br>CRI >90 2551,44 lm 122,7 lm/W | <b>Control</b><br>6444 _ _ / _ 1 <span style="float: right;">980,00 €</span><br>DALI  |
|  |  | 6444 _ _ / _ 3 <span style="float: right;">930,00 €</span><br>1-10V   |
|  |  | 6444 _ _ / _ 5 <span style="float: right;">980,00 €</span><br>Push<br>6444 _ _ / _ Z <span style="float: right;">1.050,00 €</span><br>Casambi |
| <b>Materials</b><br>Glass shade: Opal triplex Diffuser: Polycarbonate.<br>Structures: Steel. Canopy: Aluminum.   |  | <b>Packaging</b><br>1 Box 0,30 x 0,30 x 1,05 m<br>Vol 0,095 m <sup>3</sup><br>Gross weight 6,2 Kg Net weight 3,7 Kg                           |
| <b>Light Source and electronics</b><br>1 x LED STRIP 20,8 W 750 mA<br>Constant Current 750 mA<br>90-305V 50/60Hz |  | <br>  |

6446

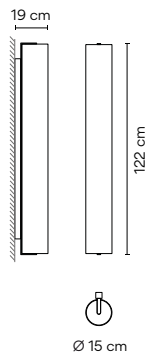

|  |  |   |
|--|--|---|
| <b>Finishes</b><br>● 11/ _ _ Black<br>(NCS S 8500-N)   | <b>LED temperature colour</b><br>/7 2200 K <b>F</b><br>CRI >90 2703,32 lm 96,9 lm/W<br>/1 2700 K <b>E</b><br>CRI >90 3153,9 lm 113 lm/W<br>/2 3000 K <b>F</b><br>CRI >90 3153,0 lm 113 lm/W<br>/3 3500 K <b>E</b><br>CRI >90 3379,15 lm 121,1 lm/W | <b>Control</b><br>6446 _ _ / _ 1 <span style="float: right;">1.245,00 €</span><br>DALI  |
|  |  | 6446 _ _ / _ 3 <span style="float: right;">1.185,00 €</span><br>1-10V   |
|  |  | 6446 _ _ / _ 5 <span style="float: right;">1.245,00 €</span><br>Push<br>6446 _ _ / _ Z <span style="float: right;">1.305,00 €</span><br>Casambi |
| <b>Materials</b><br>Glass shade: Opal triplex Diffuser: Polycarbonate.<br>Structures: Steel. Canopy: Aluminum.   |  | <b>Packaging</b><br>1 Box 0,30 x 0,30 x 1,35 m<br>Vol 0,122 m <sup>3</sup><br>Gross weight 9 Kg Net weight 6 Kg                                 |
| <b>Light Source and electronics</b><br>1 x LED STRIP 27,9 W 750 mA<br>Constant Current 750 mA<br>90-305V 50/60Hz |  | <br>  |

Pendants

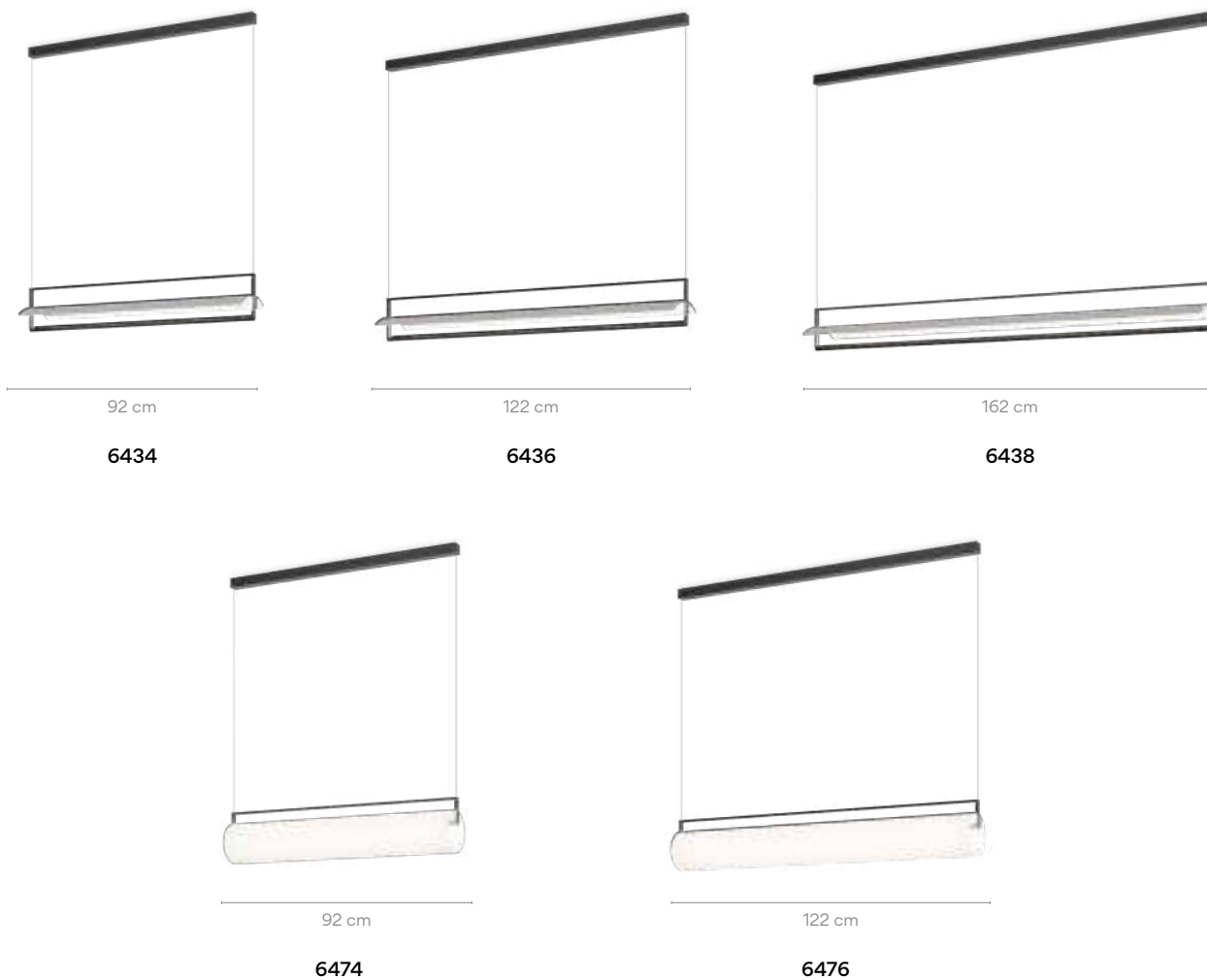

6434

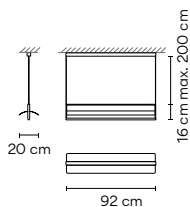

|   |  |   |
|---|--|---|
| <p><b>Finishes</b></p> <ul style="list-style-type: none"> <li>● 11/ _ _ Black (NCS S 8500-N)</li> </ul> | <p><b>LED temperature colour</b></p> <ul style="list-style-type: none"> <li>/7 _ 2200 K  CRI &gt;90 2041,15 lm 98,1 lm/W</li> <li>/1 _ 2700 K  CRI &gt;90 2381,3 lm 114 lm/W</li> <li>/2 _ 3000 K  CRI &gt;90 2381,3 lm 114 lm/W</li> <li>/3 _ 3500 K  CRI &gt;90 2551,44 lm 122,7 lm/W</li> </ul> | <p><b>Control</b></p> <p>6434 _ _ / _ 1 865,00 €<br/>DALI</p> <p>6434 _ _ / _ 3 820,00 €<br/>1-10V</p> <p>6434 _ _ / _ 5 865,00 €<br/>Push</p> <p>6434 _ _ / _ Z 940,00 €<br/>Casambi</p>   |
|   |  | <p><b>Materials</b></p> <p>Concave shade: Aluminum. Diffuser: Polycarbonate.<br/>Structures: Steel. Canopy: Aluminum.</p> <p><b>Light Source and electronics</b></p> <p>1 x LED STRIP 20,8 W 750 mA<br/>Constant Current 750 mA<br/>90-305V 50/60Hz</p> |
| <p>LED  IP20   </p> <p>Dimmer  Multi-volt </p>  |  |   |

6436

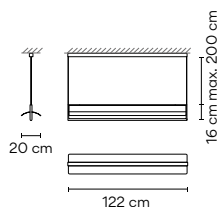

| Finishes                         | LED temperature colour                              | Control                  |            |
|----------------------------------|---|--------------------------|------------|
| ● 11/ __ Black<br>(NCS S 8500-N) | /7 2200 K <b>F</b><br>CRI >90 2703,32 lm 96,9 lm/W  | 6436 __ / _ 1<br>DALI    | 990,00 €   |
|                                  | /1 2700 K <b>E</b><br>CRI >90 3153,9 lm 113 lm/W    | 6436 __ / _ 3<br>1-10V   | 940,00 €   |
|                                  | /2 3000 K <b>F</b><br>CRI >90 3154,0 lm 113 lm/W    | 6436 __ / _ 5<br>Push    | 990,00 €   |
|                                  | /3 3500 K <b>E</b><br>CRI >90 3379,15 lm 121,1 lm/W | 6436 __ / _ Z<br>Casambi | 1.060,00 € |

Materials

Concave shade: Aluminum. Diffuser: Polycarbonate.  
Structures: Steel. Canopy: Aluminum.

Light Source and electronics

1 x LED STRIP 27,9 W 750 mA  
Constant Current 750 mA  
90~305V 50/60Hz

Packaging

1 Box 0,30 x 0,30 x 1,35 m  
Vol 0,122 m<sup>3</sup>  
Gross weight 5,8 Kg Net weight 3,8 Kg

Notes

Extra cable length. 16,00 €/m



6438

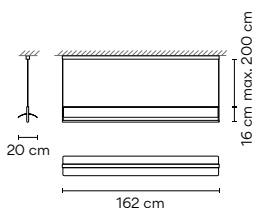

| Finishes                       | LED temperature colour                              | Control                  |            |
|--------------------------------|---|--------------------------|------------|
| 11/ __ Black<br>(NCS S 8500-N) | /7 2200 K <b>F</b><br>CRI >90 3604,42 lm 96,9 lm/W  | 6438 __ / _ 1<br>DALI    | 1.110,00 € |
|                                | /1 2700 K <b>E</b><br>CRI >90 4205,2 lm 113 lm/W    | 6438 __ / _ 3<br>1-10V   | 1.055,00 € |
|                                | /2 3000 K <b>F</b><br>CRI >90 4205,2 lm 113 lm/W    | 6438 __ / _ 5<br>Push    | 1.110,00 € |
|                                | /3 3500 K <b>E</b><br>CRI >90 4505,53 lm 121,1 lm/W | 6438 __ / _ Z<br>Casambi | 1.175,00 € |

Materials

Concave shade: Aluminum. Diffuser: Polycarbonate.  
Structures: Steel. Canopy: Aluminum.

Light Source and electronics

1 x LED STRIP 37,2 W 750 mA  
Constant Current 750 mA  
90~305V 50/60Hz

Packaging

1 Box 0,30 x 0,30 x 1,75 m  
Vol 0,158 m<sup>3</sup>  
Gross weight 6,5 Kg Net weight 4 Kg

Notes

Extra cable length. 16,00 €/m



6474

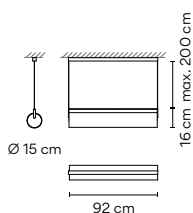

| Finishes                         | LED temperature colour                             | Control                  |            |
|----------------------------------|--|--------------------------|------------|
| ● 11/ __ Black<br>(NCS S 8500-N) | /7 2200 K <b>F</b><br>CRI >90 2041,15 lm 98,1 lm/W | 6474 __ / _ 1<br>DALI    | 1.105,00 € |
|                                  | /1 2700 K <b>E</b><br>CRI >90 2381,3 lm 114 lm/W   | 6474 __ / _ 3<br>1-10V   | 1.050,00 € |
|                                  | /2 3000 K <b>F</b><br>CRI >90 2381,3 lm 114 lm/W   | 6474 __ / _ 5<br>Push    | 1.105,00 € |
|                                  |  | 6474 __ / _ Z<br>Casambi | 1.170,00 € |

Materials

Glass shade: Opal triplex. Diffuser: Polycarbonate.  
Structures: Steel. Canopy: Aluminum.

Light Source and electronics

1 x LED STRIP 20,8 W 750 mA  
Constant Current 750 mA  
90~305V 50/60Hz

Packaging

1 Box 0,30 x 0,30 x 1,05 m  
Vol 0,095 m<sup>3</sup>  
Gross weight 6,2 Kg Net weight 3,7 Kg

Notes

Extra cable length. 16,00 €/m



6476

|                                   |                    |                              |
|-----------------------------------|--------------------|------------------------------|
| ● 11/ _ _ Black<br>(NCS S 8500-N) | Finishes           | LED temperature colour       |
|                                   | /7 2200 K <b>F</b> | CRI >90 2703,32 lm 96,9 lm/W |
|                                   | /1 2700 K <b>E</b> | CRI >90 3153,9 lm 113 lm/W   |
|                                   | /2 3000 K <b>F</b> | CRI >90 3153,0 lm 113 lm/W   |

|         |                |            |
|---------|----------------|------------|
| Control | 6476 _ _ / _ 1 | 1.405,00 € |
|         | DALI           |            |
|         | 6476 _ _ / _ 3 | 1.335,00 € |
|         | 1-10V          |            |
|         | 6476 _ _ / _ 5 | 1.405,00 € |
|         | Push           |            |
|         | 6476 _ _ / _ Z | 1.455,00 € |
|         | Casambi        |            |

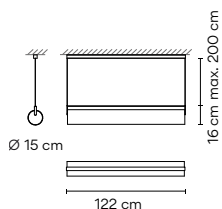

**Materials**  
 Glass shade: Opal triplex. Diffuser: Polycarbonate.  
 Structures: Steel. Canopy: Aluminum.

**Light Source and electronics**  
 1 x LED STRIP 27,9 W 750 mA  
 Constant Current 750 mA  
 90-305V 50/60Hz

**Packaging**  
 1 Box 0,75 x 0,45 x 1,35 m  
 Vol 0,122 m<sup>3</sup>  
 Gross weight 9 Kg Net weight 6 Kg

**Notes**  
 Extra cable length. 16,00 €/m

- LED IP20 CE EAC
- Dimmer Multi-volt







# Sticks Connectable

Design by Arik Levy

Fusing technology, space, and architecture, Sticks offers a creative toolkit for integrating light elements in an interior. Pure and graphic, the minimalist aluminum rods transform linear light into floating sculpture.



You can chose the desired composition through one of the following three options:

**A - Choose among pre-designed layouts the one that fits with your project and order it directly (see page 366).**

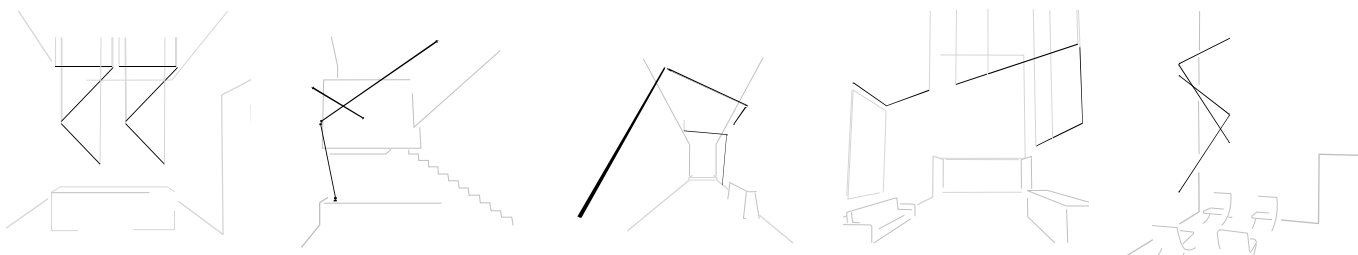

**B - Select one composition on [vibia.com](http://vibia.com) among multiple applications in spaces, and adjust it to your project by modifying:**

- + Length of the sticks.
- + Position of each stick in the space.
- + Colour temperature and dimming.
- + Installation type.

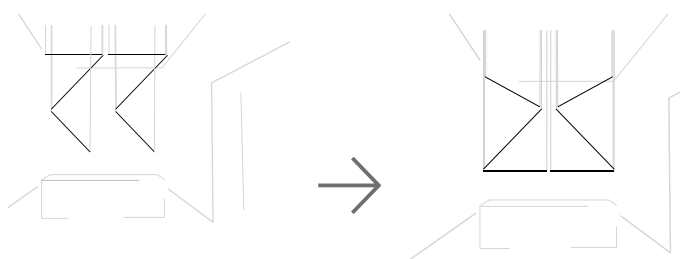

**C - Create your configuration on [vibia.com](http://vibia.com) from scratch in three easy steps, without sketches.**

1

Choose the location for your electrical connection point



2

Add connectable Sticks up to 6.5 meters



3

Configure  
+ Colour temperature  
+ Dimming control  
+ Installation type  
+ Pendants height



# Technical Specifications

(see page 374)

The Sticks collection has three sizes: 1.5 m, 2 m, or 3 m, and they can be connected one to each other to a total maximum length of 6.5 meters per electrical connection.

## Wall-Wall / Ceiling-Ceiling

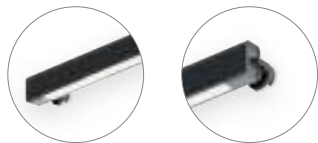

## Wall-Wall (corner) / Wall-Ceiling

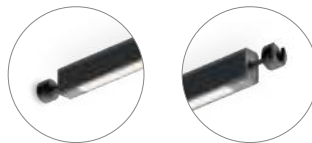

## Wall-Pendants

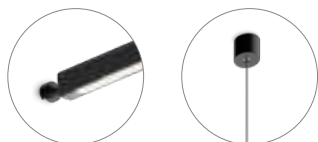

## Pendants-Pendants

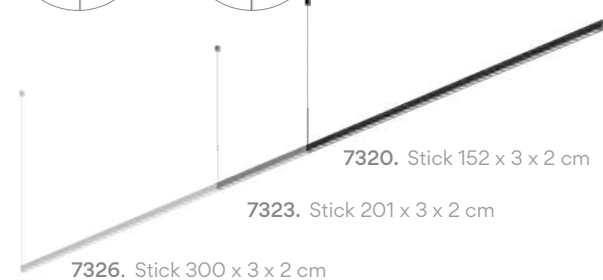
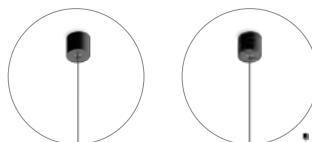

## Pendants

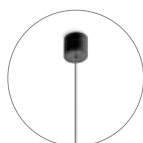

## Floor-Wall



# Sticks Connectable

Next sketches are composed by one or more compositions

## Pendant / Ceiling

---

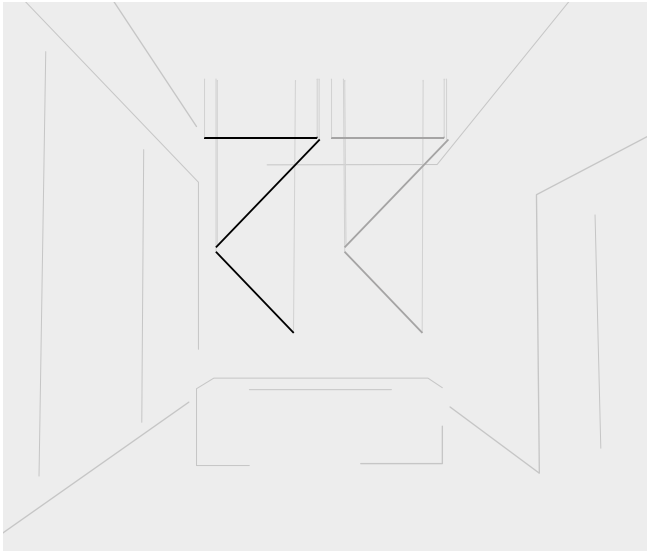

### ST1001

Sketch composed by two identical compositions.

#### Each composition:

3 Sticks: 2 x 150 cm, 1 x 200 cm. Total 5 m.

LED 4000 K. 11870 lm. 88 W.

Remote driver Built-in Micro. 1-10V.

Price 1.715,00 € / each composition

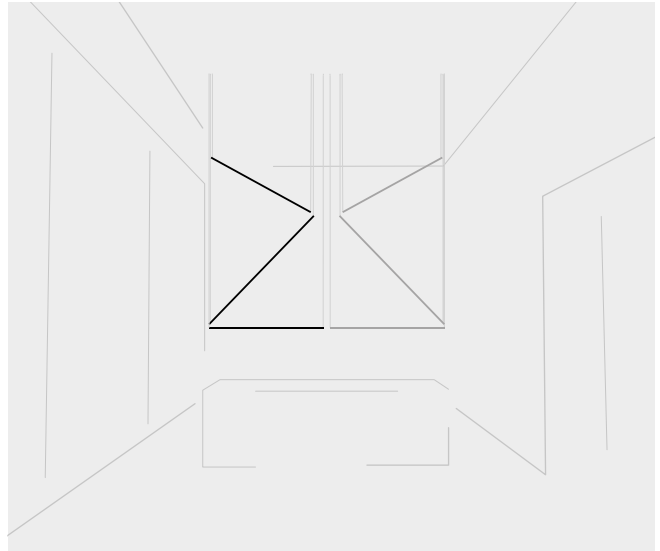

### ST1005

Sketch composed by two identical compositions.

#### Each composition:

3 Sticks: 2 x 150 cm, 1 x 200 cm. Total 5 m.

LED 4000 K. 11870 lm. 88 W.

Remote driver Built-in Micro. 1-10V.

Price 1.715,00 € / each composition

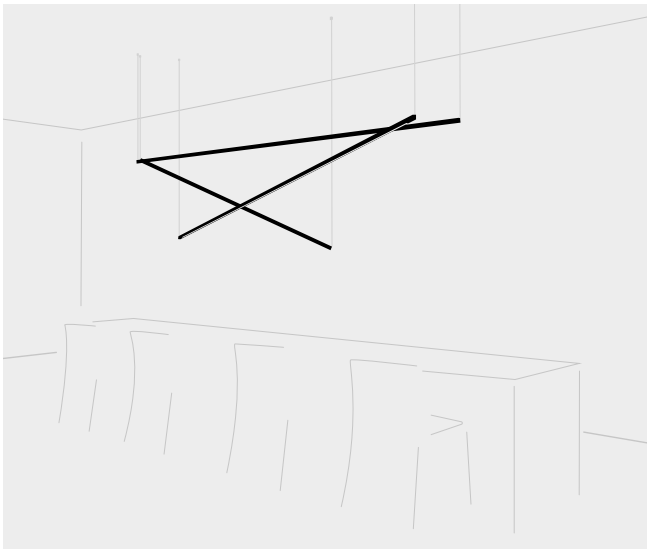

### ST1015

Sketch composed by two compositions.

#### Composition 1:

2 Sticks: 1 x 150 cm, 1 x 300 cm. Total 4,5 m.

LED 2700 K. 9779 lm. 79,2 W.

Built-in disc S canopy. 1-10V.

#### Composition 2:

1 Stick: 1 x 300 cm. Total 3 m.

LED 2700 K. 6519 lm. 52,8 W.

Built-in disc S canopy. 1-10V.

Price 2.650,00 €

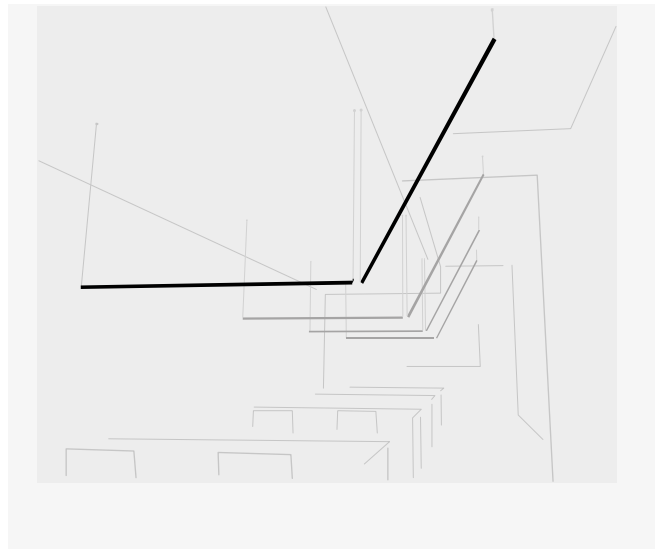

### ST1021

Sketch composed by four identical compositions.

#### Each composition:

2 Sticks: 2 x 200 cm. Total 4 m.

LED 4000 K. 9496 lm. 140,8 W.

Built-in disc S canopy. 1-10V.

Price 1.400,00 € / each composition

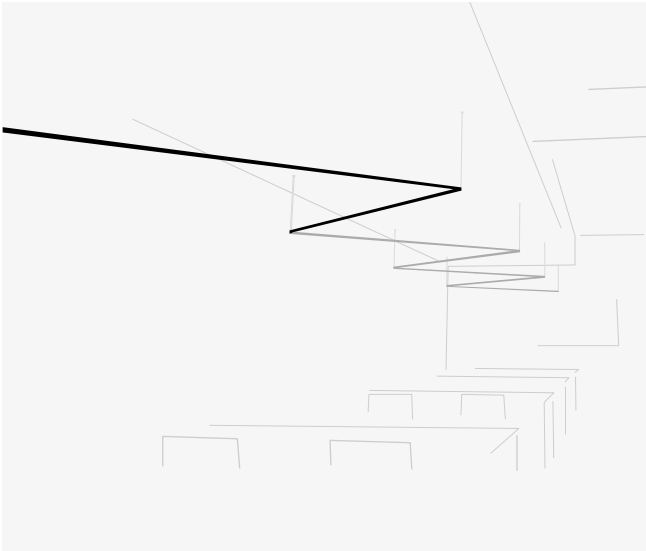

**ST1025**

Sketch composed by four identical compositions.

Each composition:

2 Sticks: 2 x 300 cm. Total 6 m.  
LED 4000 K. 14244 lm. 105,6 W.  
Built-in disc S canopy. 1-10V.

Price 2.015,00 € / each composition

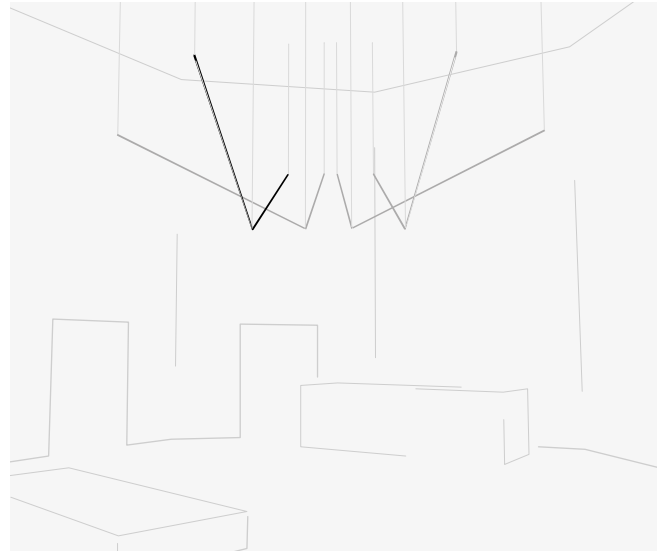

**ST1035**

Sketch composed by four identical compositions.

Each composition:

2 Sticks: 1 x 300 cm, 1 x 150 cm. Total 4,5 m.  
LED 4000 K. 10683 lm. 79,2 W.  
Built-in disc S canopy. 1-10V.

Price 1.550,00 € / each composition

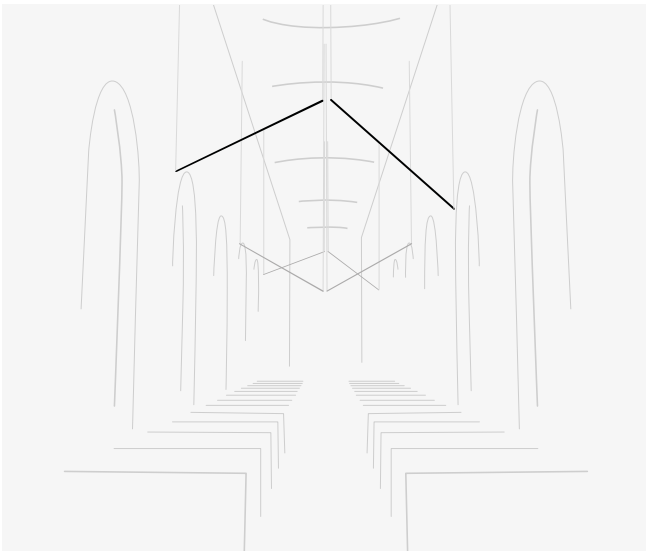

**ST1041**

Sketch composed by three identical compositions.

Each composition:

2 Sticks: 2 x 300 cm. Total 6 m.  
LED 4000 K. 14244 lm. 105,6 W.  
Built-in disc S canopy. 1-10V.

Price 2.015,00 € / each composition

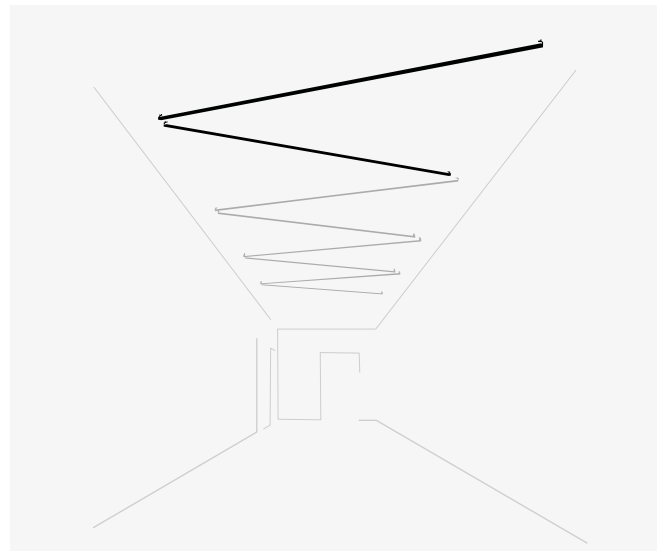

**ST1085**

Sketch composed by four identical compositions.

Each composition:

2 Sticks: 2 x 300 cm. Total 6 m.  
LED 4000 K. 14244 lm. 105,6 W.  
Remote driver Built-in Micro. 1-10V.

Price 2.015,00 € / each composition

# Sticks Connectable

Next sketches are composed by one or more compositions

Some sticks are attached to the Wall

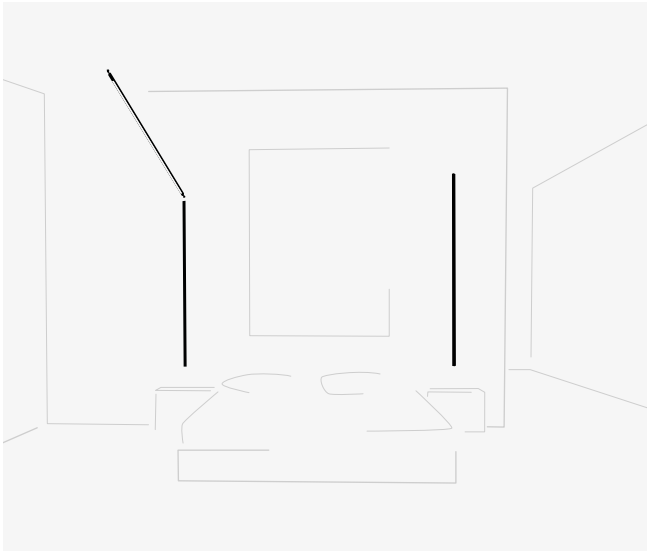

**STI051**  
Sketch composed by two compositions.

**Composition 1:**  
2 Sticks: 2 x 150 cm. Total 3 m.  
LED 2700 K. 6520 lm. 52,8 W.  
Floor base & plug. Push.

**Composition 2:**  
1 Stick: 1 x 200 cm. Total 2 m.  
LED 2700 K. 4346 lm. 35,2 W.  
Floor base & plug. Push.

**Price 2.220,00 €**

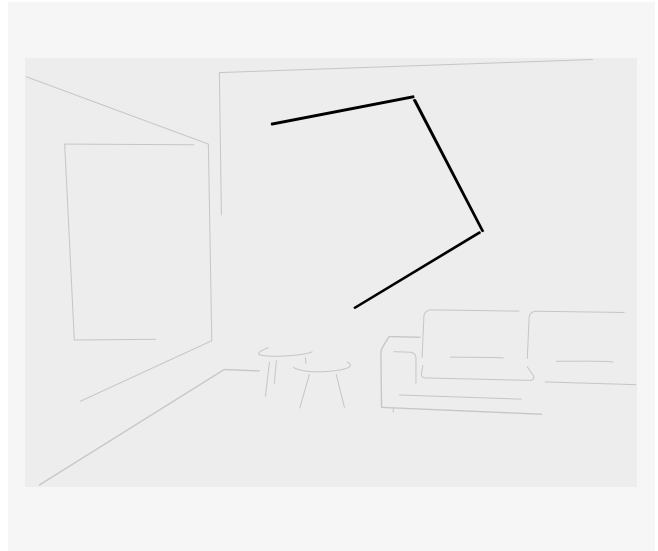

**STI055**  
Sketch composed by only one composition.

3 Sticks: 3 x 150 cm. Total 4,5 m.  
LED 2700 K. 9780 lm. 79,2 W.  
Floor base & plug. Push.

**Price 1.710,00 €**

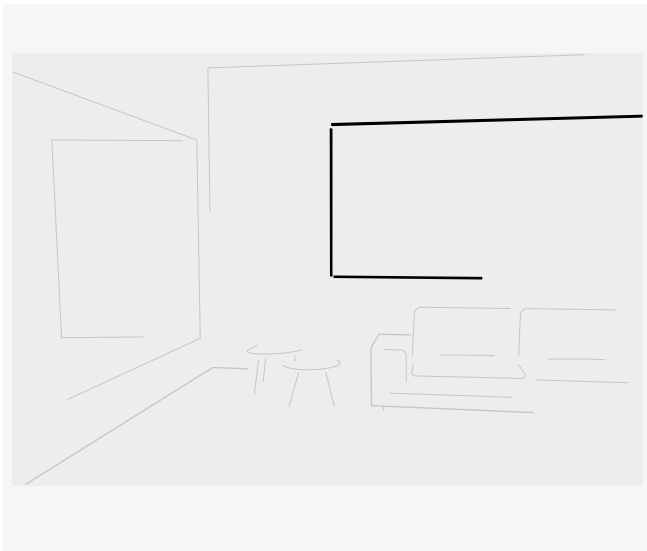

**STI061**  
Sketch composed by only one composition.

3 Sticks: 2 x 150 cm, 1 x 300 cm. Total 6 m.  
LED 2700 K. 13039 lm. 105,6 W.  
Floor base & plug. Push.

**Price 2.180,00 €**

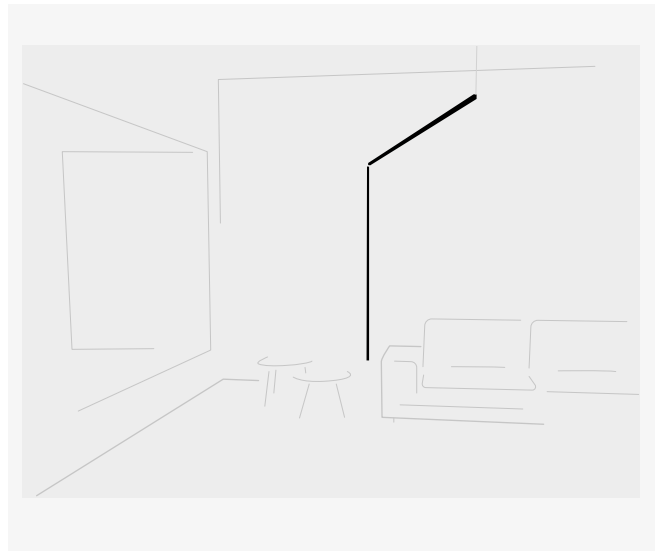

**STI065**  
Sketch composed by only one composition.

2 Sticks: 2 x 150 cm. Total 3 m.  
LED 2700 K. 6520 lm. 52,8 W.  
Floor base & plug. Push.

**Price 1.260,00 €**

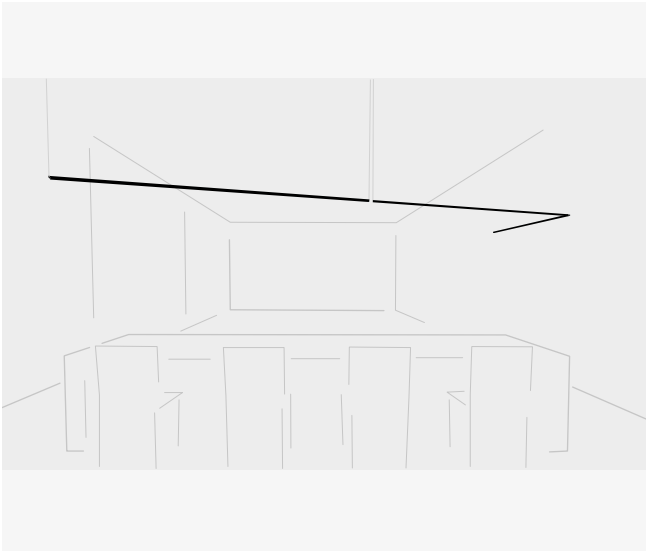

**ST1071**

Sketch composed by only one composition.

3 Sticks: 1 x 150 cm, 2 x 200 cm. Total 5,5 m.  
LED 2700 K. 11952 lm. 96,8 W.  
Floor base & plug. Push.

**Price 2.030,00 €**

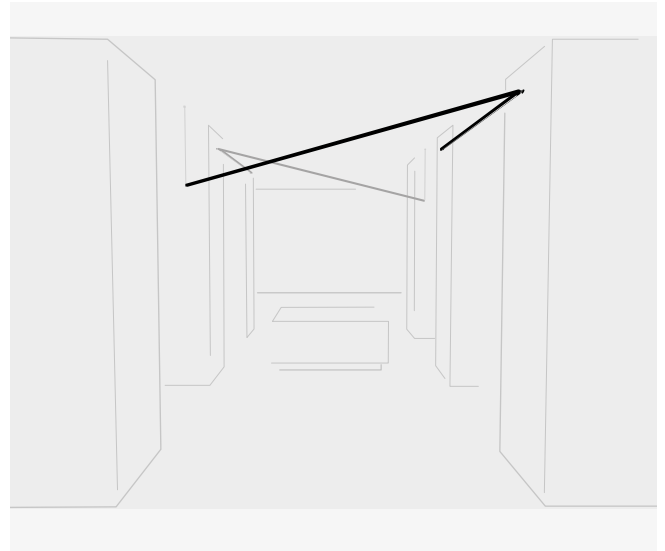

**ST1075**

Sketch composed by two identical compositions.

Each composition:  
2 Sticks: 2 x 300 cm. Total 6 m.  
LED 4000 K. 14244 lm. 105,6 W.  
Remote driver Built-in Micro. 1-10V.

**Price 2.015,00 € / each composition**

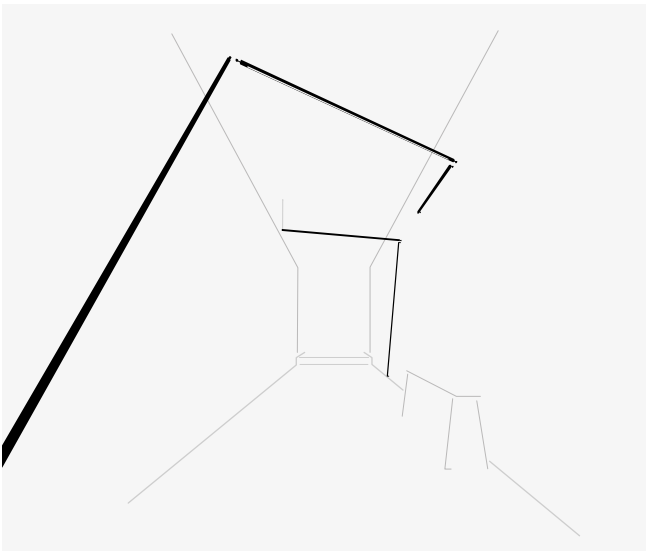

**ST1081**

Sketch composed by two compositions.

Composition 1:  
3 Sticks: 1 x 150 cm, 1 x 200 cm, 1 x 300 cm. Total 6,5 m.  
LED 4000 K. 15431 lm. 114,4 W.  
Remote driver Built-in Micro. 1-10V.

Composition 2:  
2 Sticks: 1 x 300 cm, 1 x 200 cm. Total 5 m.  
LED 4000 K. 11870 lm. 88 W.  
Remote driver Built-in Micro. 1-10V.

**Price 3.880,00 €**

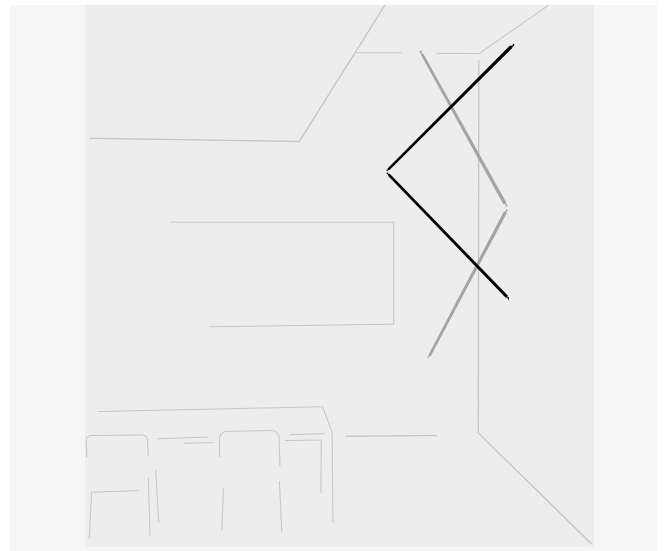

**ST1091**

Sketch composed by two identical compositions.

Each composition:  
2 Sticks: 2 x 200 cm. Total 4 m.  
LED 2700 K. 8692 lm. 70,4 W.  
Remote driver Built-in Micro. 1-10V.

**Price 1.400,00 € / each composition**

# Sticks Connectable

Next sketches are composed by one or more compositions

## Some sticks are attached to the Wall

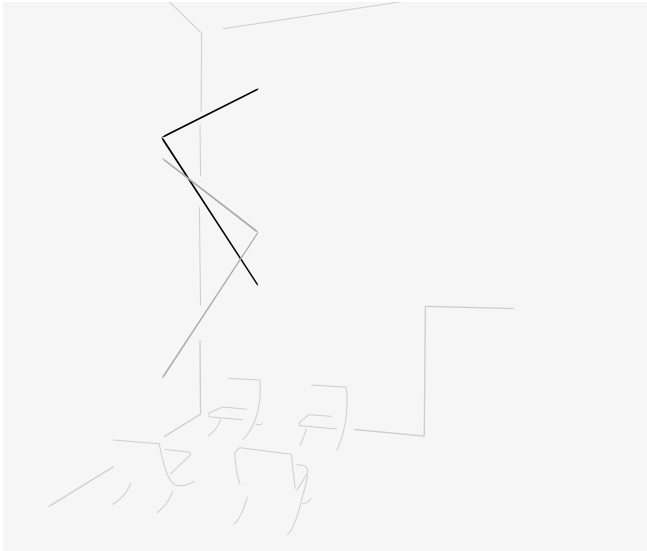

### ST1095

Sketch composed by two identical compositions.

#### Each composition:

2 Sticks: 1 x 200 cm, 1 x 300 cm. Total 5 m.  
LED 4000 K. 11870 lm. 88 W.  
Remote driver Built-in Micro. 1-10V.

Price 1.715,00 € / each composition

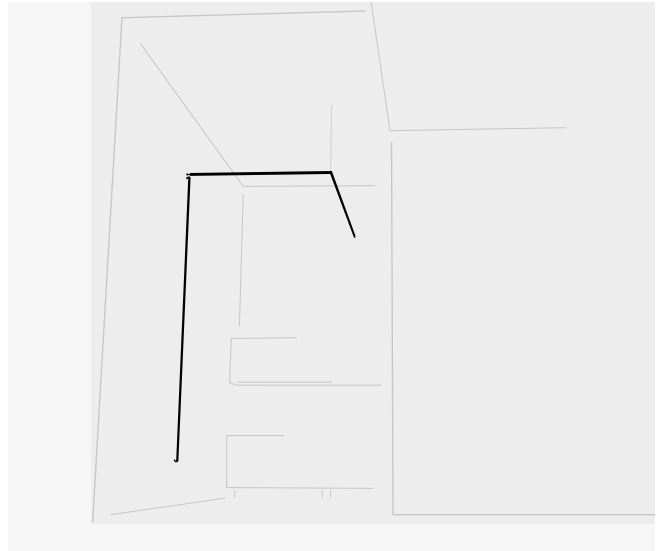

### ST1101

Sketch composed by two compositions.

#### Composition 1:

2 Sticks: 1 x 300 cm, 1 x 150 cm. Total 4,5 m.  
LED 2700 K. 9779 lm. 79,2 W.  
Remote driver Built-in Micro. 1-10V.

#### Composition 2:

1 Stick: 1 x 300 cm. Total 3 m.  
LED 2700 K. 6519 lm. 52,8 W.  
Remote driver Built-in Micro. 1-10V.

Price 2.650,00 €

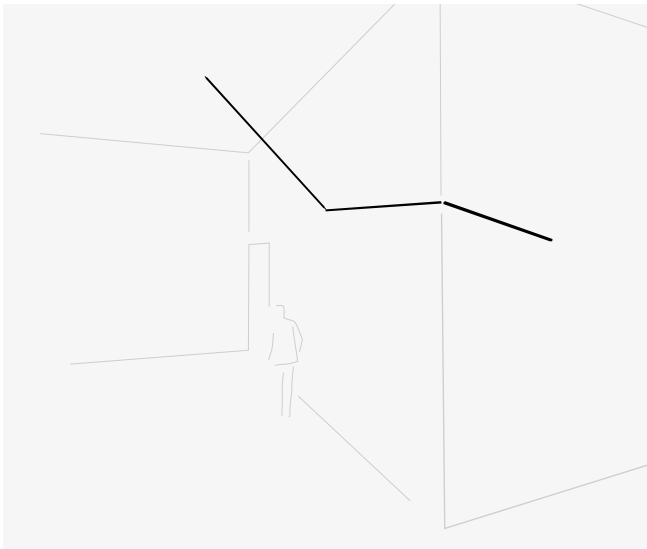

### ST1105

Sketch composed by only one composition.

3 Sticks: 2 x 150 cm, 1 x 200 cm. Total 5 m.  
LED 4000 K. 11870 lm. 88 W.  
Floor base & plug. Push.

Price 1.880,00 €

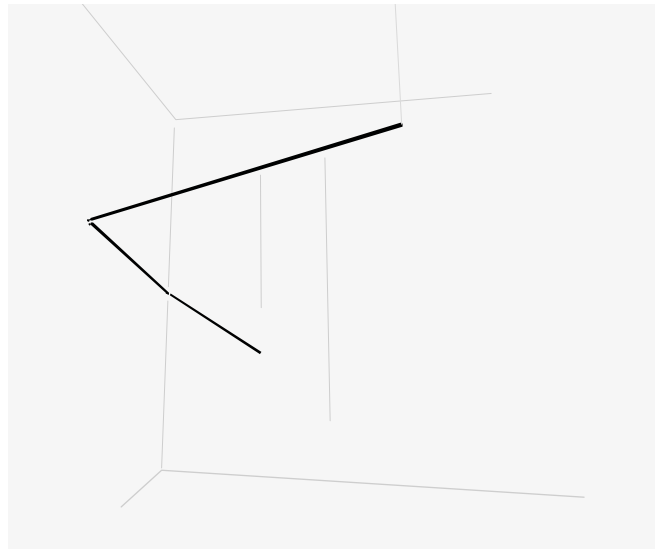

### ST1111

Sketch composed by only one composition.

3 Sticks: 2 x 150 cm, 1 x 300 cm. Total 6 m.  
LED 4000 K. 14244 lm. 105,6 W.  
Remote driver Built-in Micro. 1-10V.

Price 2.015,00 €





**ST115**

Sketch composed by three identical compositions.

**Each composition:**

2 Sticks: 2 x 200 cm. Total 4 m.  
LED 4000 K. 9496 lm. 70,4 W.  
Built-in disc S canopy. 1-10V.

**Price 1.400,00 € / each composition**

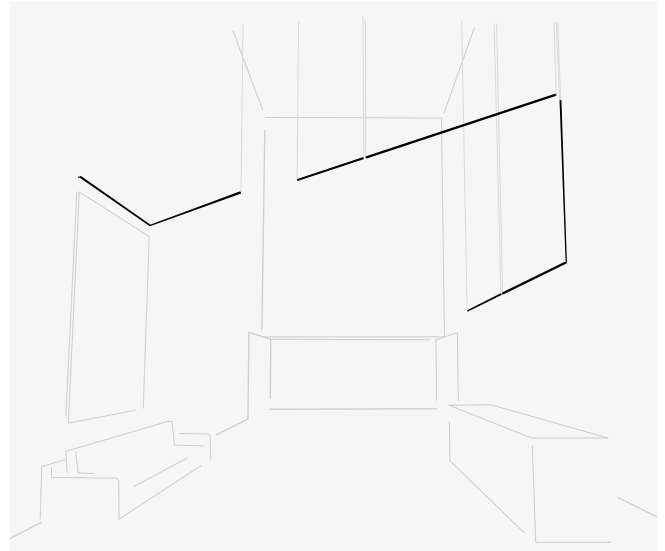

**ST131**

Sketch composed by four compositions.

**Composition 1:**

2 Sticks: 2 x 300 cm. Total 6 m.  
LED 4000 K. 14244 lm. 105,6 W.  
Remote driver Built-in Micro. 1-10V.

**Composition 2:**

1 Stick: 1 x 150 cm. Total 1,5 m.  
LED 4000 K. 3561 lm. 26,4 W.  
Remote driver Built-in Micro. 1-10V.

**Composition 3:**

2 Sticks: 2 x 300 cm. Total 6 m.  
LED 4000 K. 14244 lm. 105,6 W.  
Remote driver Built-in Micro. 1-10V.

**Composition 4:**

2 Sticks: 2 x 300 cm. Total 6 m.  
LED 4000 K. 14244 lm. 105,6 W.  
Remote driver Built-in Micro. 1-10V.

**Price 6.695,00 €**

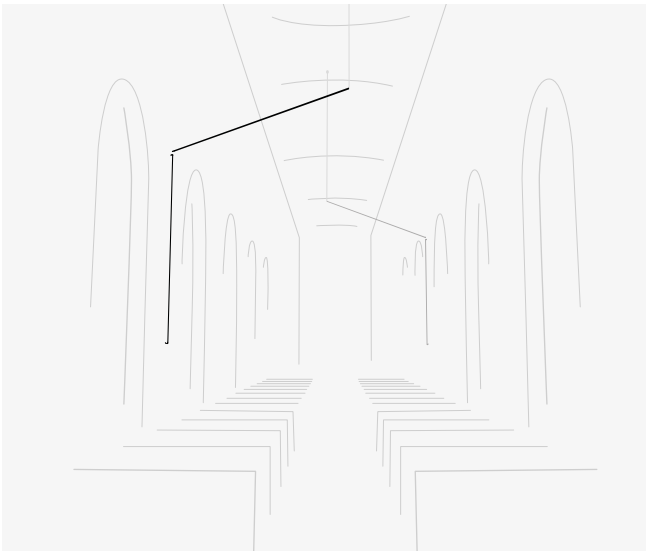

**ST141**

Sketch composed by two identical compositions.

**Each composition:**

2 Sticks: 2 x 300 cm. Total 6 m.  
LED 4000 K. 14244 lm. 105,6 W.  
Built-in disc S canopy. 1-10V.

**Price 2.015,00 € / each composition**

# Sticks Connectable

Next sketches are composed by one or more compositions

## Some sticks are attached to the Wall

---

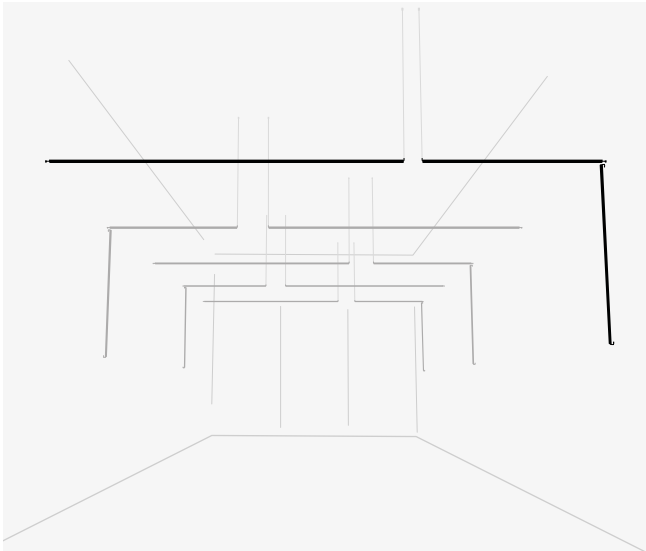

### ST1145

Sketch composed by five identical compositions.

#### Each composition:

3 Sticks: 1 x 300 cm, 2 x 150 cm . Total 6 m.

LED 4000 K. 14244 lm. 105,6 W.

Remote driver Built-in Micro. 1-10V

Price 2.015,00 € / each composition

## Some sticks are on the Floor

---

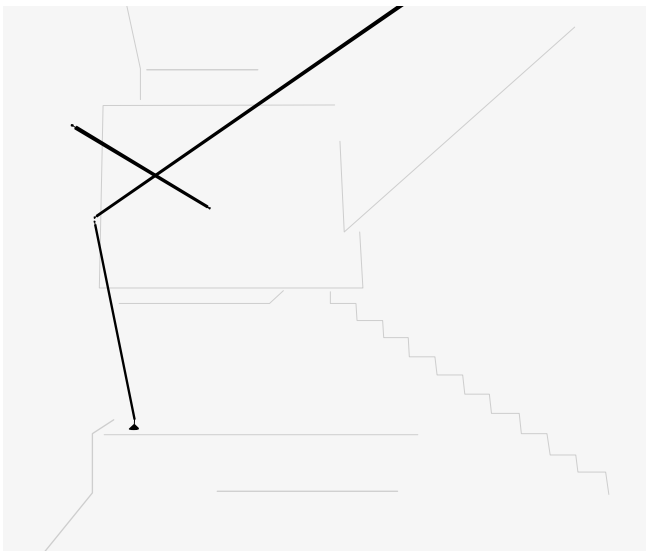

### ST1151

Sketch composed by two compositions.

#### Composition 1:

1 Stick: 1 x 150 cm. Total 1,5 m.

LED 2700 K. 3260 lm. 26,4 W.

Remote driver Built-in Micro. 1-10V.

#### Composition 2:

2 Sticks: 1 x 200 cm, 1 x 300 cm. Total 5 m.

LED 2700 K. 10865 lm. 88 W.

Remote driver Built-in Micro. 1-10V.

Price 2.365,00 €

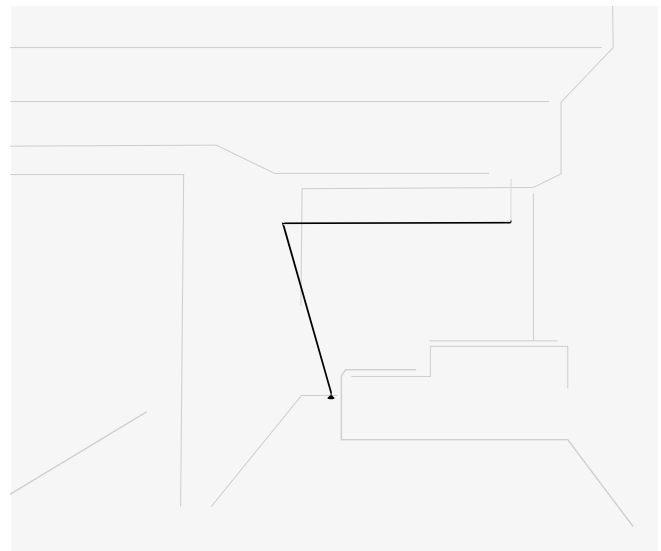

### ST1155

Sketch composed by only one composition.

2 Sticks: 2 x 300 cm. Total 6 m.

LED 4000 K. 14244 lm. 105,6 W.

Floor base & plug. Push.

Price 2.180,00 €

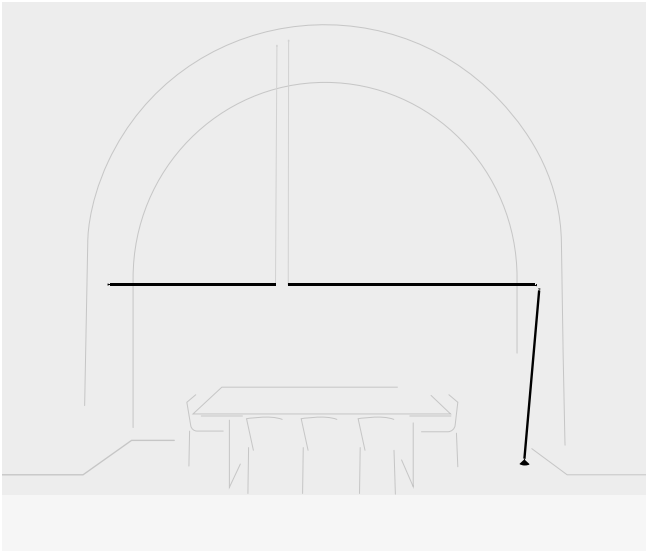

**ST1161**

Sketch composed by two compositions.

**Composition 1:**

1 Stick: 1 x 200 cm. Total 2 m.

LED 2700 K. 4336 lm. 35,2 W.

Remote driver Built-in Micro. 1-10V. Remote driver Built-in Micro. 1-10V.

**Composition 2:**

2 Sticks: 1 x 300 cm, 1 x 200 cm. Total 5 m.

LED 2700 K. 10865 lm. 88 W.

**Price 2.515,00 €**

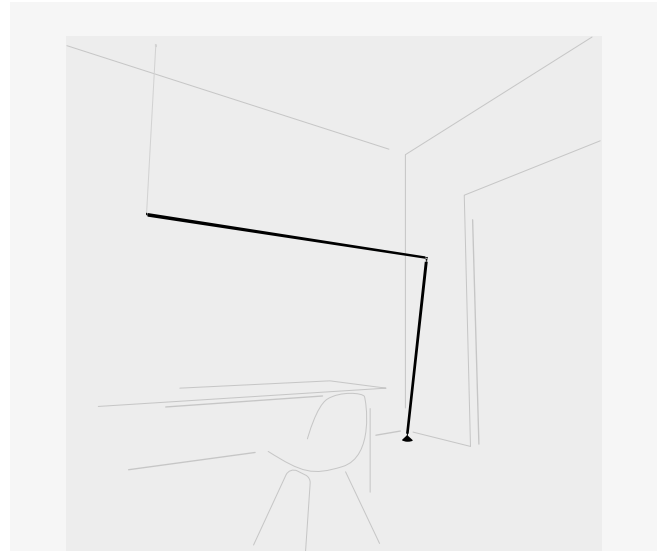

**ST1165**

Sketch composed by only one composition.

2 Sticks: 1 x 300 cm, 1 x 200 cm. Total 5 m.

LED 2700 K. 10865 lm. 88 W.

Floor base & plug. Push.

**Price 1.880,00 €**



**ST1171**

Sketch composed by two compositions.

**Composition 1:**

3 Sticks: 3 x 200 cm. Total 6 m.

LED 4000 K. 14244 lm. 105,6 W.

Surface canopy. 1-10V.

**Composition 2:**

2 Sticks: 1 x 200 cm, 1 x 300 cm. Total 5 m.

LED 4000 K. 11870 lm. 88 W.

Surface canopy. 1-10V.

**Price 3.990,00 €**

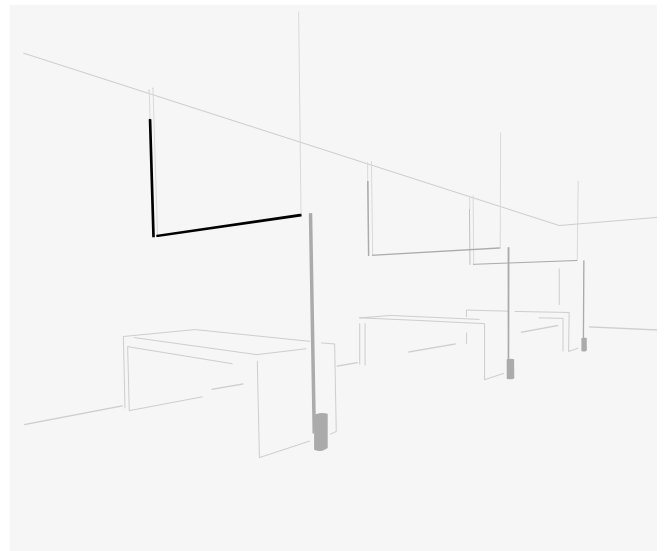

**ST1175**

Sketch composed by three identical compositions.

**Each composition:**

2 Sticks: 1 x 150 cm, 1 x 200 cm. Total 3,5 m.

LED 4000 K. 8309 lm. 61,6 W.

Surface canopy. 1-10V.

**Price 1.380,00 € / each composition**



Each project is unique.  
Visit [vibia.com](http://vibia.com) and chose among  
multiple compositions designed  
and adapted to your project needs.

Personalize your own Sticks composition  
quick and easy at [vibia.com](http://vibia.com).

# Sticks Connectable



## Elements to be configured

Wall-Wall / Ceiling-Ceiling  
Wall-Wall (corner) / Wall-Ceiling  
Wall-Pendants  
Pendants-Pendants  
Pendants-Ceiling  
Pendants

### Sticks 1,5 m.

7300 7310 7320 7330 7350

LED temperature colour

- /1 \_ 2700 K  CRI >90 3260 lm 123 lm/W  
/2 \_ 3000 K  CRI >90 3510 lm 133 lm/W  
/4 \_ 4000 K  CRI >90 3561 lm 134 lm/W



1 x LED STRIP 26,4 W 24V

Net weight 0,9 Kg.

### Sticks 2 m.

7303 7313 7323 7333 7353

LED temperature colour

- /1 \_ 2700 K  CRI >90 4346 lm 123 lm/W  
/2 \_ 3000 K  CRI >90 4680 lm 133 lm/W  
/4 \_ 4000 K  CRI >90 4748 lm 134 lm/W

1 x LED STRIP 35,2 W 24V

Net weight 1,2 Kg.

### Sticks 3 m.

7306 7316 7326 7336 7356

LED temperature colour

- /1 \_ 2700 K  CRI >90 6519 lm 123 lm/W  
/2 \_ 3000 K  CRI >90 7020 lm 133 lm/W  
/4 \_ 4000 K  CRI >90 7122 lm 134 lm/W

1 x LED STRIP 52,8 W 24V

Net weight 1,8 Kg.

Sticks: Aluminum.

Diffuser: Polycarbonate.

**Driver and Dimming** depends on selected installation accessory (see page 375).

Suspension cables up to 3m. for Wall - Pendants and Pendants-Pendants.

**Personalisation options available**

- Extra cable length for Wall - Pendants and Pendants - Pendants.

Min. quantity, upcharge and extra lead time apply.

11 Black

(NCS S 8500-N)





Horizontal Pendants version with a UGR index <19 available. Request more information.

## Floor-Wall

### Sticks 1,5 m.

7340

LED temperature colour

- /1 \_ 2700 K  CRI >90 3260 lm 123 lm/W  
/2 \_ 3000 K  CRI >90 2644 lm 100,15 lm/W  
/4 \_ 4000 K  CRI >90 3561 lm 134 lm/W



1 x LED STRIP 26,4 W 24V

Net weight 1,5 Kg.

### Sticks 2 m.

7343

LED temperature colour

- /1 \_ 2700 K  CRI >90 4346 lm 123 lm/W  
/2 \_ 3000 K  CRI >90 2644 lm 100,15 lm/W  
/4 \_ 4000 K  CRI >90 4748 lm 134 lm/W



1 x LED STRIP 35,2 W 24V

Net weight 1,8 Kg.

### Sticks 3 m.

7306 7316 7326 7336 7356

LED temperature colour

- /1 \_ 2700 K  CRI >90 6519 lm 123 lm/W  
/2 \_ 3000 K  CRI >90 5288 lm 100,15 lm/W  
/4 \_ 4000 K  CRI >90 7122 lm 134 lm/W

1 x LED STRIP 52,8 W 24V

Net weight 2,4 Kg.

Sticks: Aluminum.

Diffuser: Polycarbonate.

**Driver and Dimming** depends on selected installation accessory (see page 375).

11 Black

(NCS S 8500-N)

# Electrical connection options



Floor base & plug



Surface canopy



Built-in disc S



Remote driver Built-in Micro

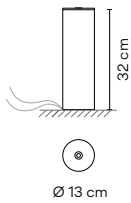

**Floor base & plug**  
ACST000001 ACST000002  
**Driver** Constant Voltage 24V.  
90~305V. 50/60Hz.  
**Dimming:** Push.

**Materials**  
Body: Steel.

**11 Black**  
(NCS S 8500-N)

**Packaging**  
1 Box.  
0,16 x 0,16 x 0,4 m.  
Vol. 0,01 m<sup>3</sup>.  
Gross weight 8,5 Kg.  
Net weight 7 Kg.

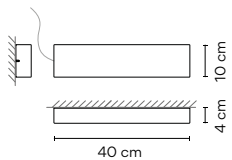

**Surface canopy**  
ACST000003 ACST000004  
**Driver** Constant Voltage 24V.  
90~305V. 50/60Hz.  
**Dimming:** 1-10V.

**Materials**  
Body: Steel.

**11 Black**  
(NCS S 8500-N)

**Packaging**  
1 Box.  
0,50 x 0,25 x 0,25 m.  
Vol. 0,03 m<sup>3</sup>.  
Gross weight 2,9 Kg.  
Net weight 2,5 Kg.



**Personalisation options available**  
- Dimming: DALI, Casambi.  
Min. quantity, upcharge and extra lead time apply.  
To be installed on ceiling or wall.

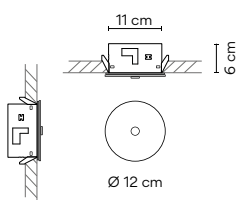

**Built-in disc S**  
ACST000005 ACST000006  
**Driver** Constant Voltage 24V.  
90~305V. 50/60Hz.  
**Dimming:** 1-10V.

**Materials**  
Body: Steel.

**11 Black**  
(NCS S 8500-N)

**Packaging**  
1 Box.  
0,25 x 0,25 x 0,25 m.  
Vol. 0,01 m<sup>3</sup>.  
Gross weight 1,8 Kg.  
Net weight 1,5 Kg.



**Personalisation options available**  
- Dimming: DALI, Casambi.  
Min. quantity, upcharge and extra lead time apply.  
To be installed on ceiling or wall.

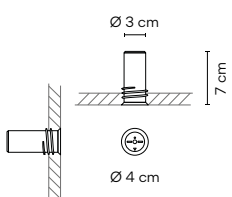

**Remote driver Built-in Micro**  
ACST000007 ACST000008  
**Driver** Constant Voltage 24V.  
90~305V. 50/60Hz.  
**Dimming:** 1-10V.

**Materials**  
Body: Aluminum.

**11 Black**  
(NCS S 8500-N)

**Packaging**  
1 Box.  
0,25 x 0,25 x 0,25 m.  
Vol. 0,01 m<sup>3</sup>.  
Gross weight 1,8 Kg.  
Net weight 1,5 Kg.



**Personalisation options available**  
- Dimming: DALI, Casambi.  
Min. quantity, upcharge and extra lead time apply.  
To be installed on ceiling or wall.

# Sticks Stand-alone

Design by Arik Levy

Fusing technology, space, and architecture, Sticks offers a creative toolkit for integrating light elements in an interior. Pure and graphic, the minimalist aluminum rods transform linear light into floating sculpture.

## Floor

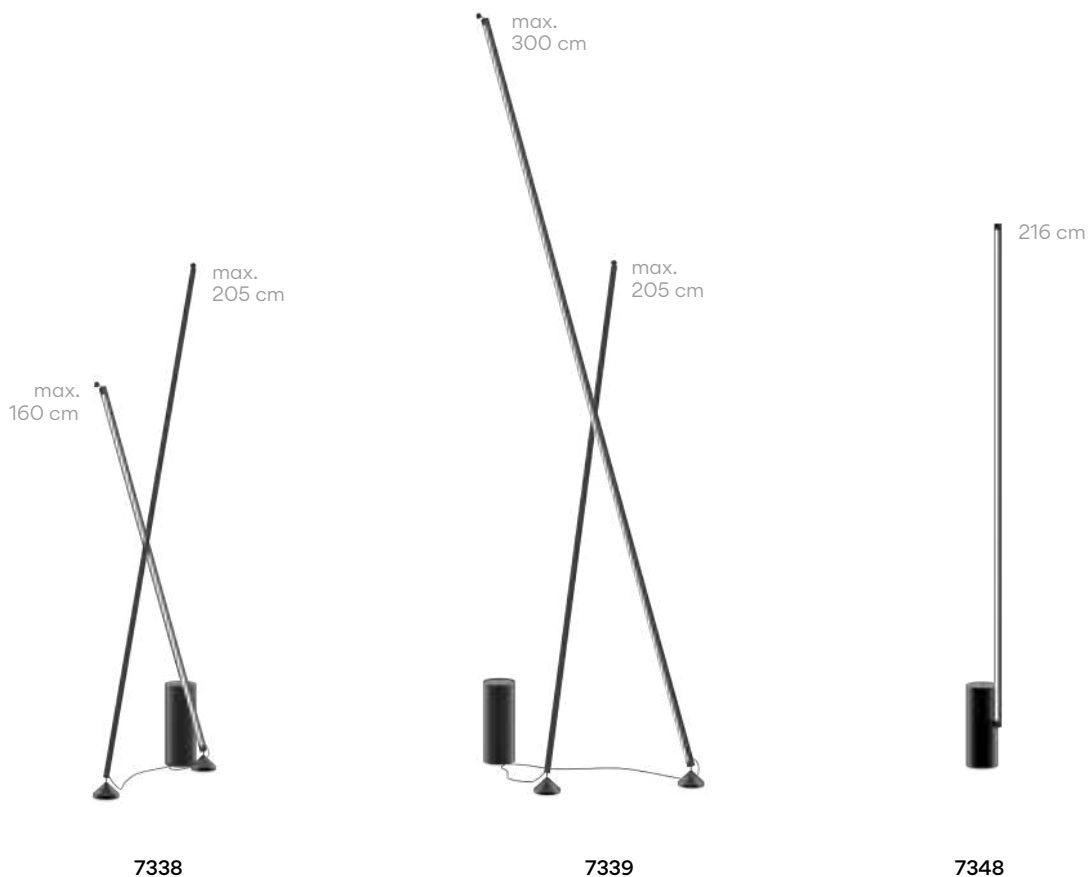



7338

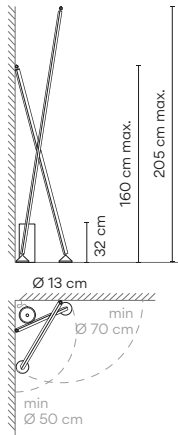

Finishes  
 ● 11/ \_\_ Black  
 (NCS S 8500-N)

LED temperature colour  
 /1 \_ 2700 K [F] >90 7606 lm 123 lm/W  
 /2 \_ 3000 K [F] >90 7606 lm 123 lm/W  
 /4 \_ 4000 K [F] >90 8309 lm 134 lm/W

Control  
 7338 \_\_ / \_ 5  
 Push 1.845,00 €

Materials  
 Sticks: Aluminum.  
 Diffuser: Polycarbonate.

Light Source and electronics  
 1 x LED STRIP 26,4 W 24V  
 1 x LED STRIP 35,2 W 24V  
 Constant Voltage 24V  
 200~240V 50/60Hz

Packaging  
 2 Boxes  
 Total Vol 0,0414 m<sup>3</sup>  
 Gross weight 14,2 Kg Net weight 9,7 Kg



7339

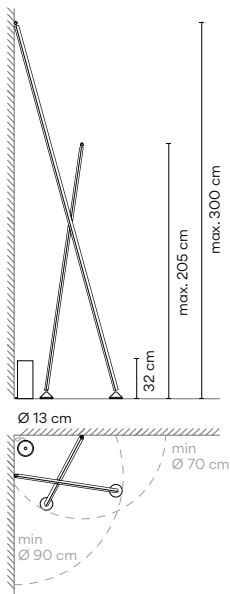

Finishes  
 ● 11/ \_\_ Black  
 (NCS S 8500-N)

LED temperature colour  
 /1 \_ 2700 K [F] >90 10865 lm 123 lm/W  
 /2 \_ 3000 K [F] >90 7606 lm 123 lm/W  
 /4 \_ 4000 K [F] >90 11870 lm 134 lm/W

Control  
 7339 \_\_ / \_ 5  
 Push 2.085,00 €

Materials  
 Sticks: Aluminum.  
 Diffuser: Polycarbonate.

Light Source and electronics  
 1 x LED STRIP 35,2 W 24V  
 1 x LED STRIP 52,8 W 24V  
 Constant Voltage 24V  
 200~240V 50/60Hz

Packaging  
 2 Boxes  
 Total Vol 0,057 m<sup>3</sup>  
 Gross weight 16,6 Kg Net weight 10,6 Kg



7348

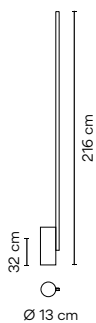

Finishes  
 ● 11/ \_\_ Black  
 (NCS S 8500-N)

LED temperature colour  
 /1 \_ 2700 K [F] >90 4346 lm 123 lm/W  
 /2 \_ 3000 K [F] >90 3511 lm 133 lm/W  
 /4 \_ 4000 K [F] >90 4748 lm 134 lm/W

Control  
 7348 \_\_ / \_ 5  
 Push 1.040,00 €

Materials  
 Sticks: Aluminum.  
 Diffuser: Polycarbonate.

Light Source and electronics  
 1 x LED STRIP 35,2 W 24V  
 Constant Voltage 24V  
 200~240V 50/60Hz

Packaging  
 2 Boxes  
 Total Vol 0,0166 m<sup>3</sup>  
 Gross weight 8,8 Kg Net weight 8,4 Kg



# Musa

Design by Note Design Studio

Delicate elegance.  
It explores the delicacy of nature  
which is both strong and powerful,  
in a poetic expression of light.

## Table Wall



ø 26 cm

7400



ø 26 cm

7402 7404



ø 26 cm

7415

### 7400

#### Finishes

- 36/ \_\_ Soft Pink (NCS S 1010-Y50R)
- 24/ \_\_ Beige M1 (NCS S 2005-Y50R)
- 93/ \_\_ White (RAL 9016)

Finish customization  
(Available options:  
Vibia colour palette)

#### LED temperature colour

/1 2700 K   
CRI >90 449 lm 100 lm/W

#### Control

7400 \_\_ / \_ 5  
Push

375,00 €

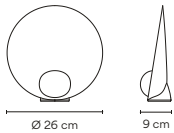

#### Materials

Diffuser: Blown glass.  
Body: Aluminum.

#### Light Source and electronics

1 x LED 4,5 W 350 mA  
Constant Voltage 24V  
100~240V 50/60Hz

#### Packaging

1 Box 0,17 x 0,32 x 0,3 m  
Vol 0,0163 m<sup>3</sup>  
Gross weight 1,3 Kg Net weight 0,85 Kg

#### Notes

Dimmer switch on the base.  
Electric cable with plug. 3 m



Bi-volt Dimmer

### 7402

#### Finishes

- 36/ \_\_ Soft Pink (NCS S 1010-Y50R)
- 24/ \_\_ Beige M1 (NCS S 2005-Y50R)
- 93/ \_\_ White (RAL 9016)

Finish customization  
(Available options:  
Vibia colour palette)

#### LED temperature colour

/1 2700 K   
CRI >90 449 lm 100 lm/W

#### Control

7402 \_\_ / \_ 5  
Push

370,00 €



#### Materials

Diffuser: Blown glass.  
Body: Aluminum.

#### Light Source and electronics

1 x LED 4,5 W 350 mA  
Constant Voltage 24V  
100~240V 50/60Hz

#### Packaging

1 Box 0,17 x 0,32 x 0,3 m  
Vol 0,0163 m<sup>3</sup>  
Gross weight 1,3 Kg Net weight 0,85 Kg

#### Notes

Dimmer switch on the base.  
Electric cable with plug. 3 m

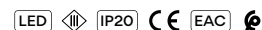

Bi-volt Dimmer

7404

- Finishes**
- 36/ \_ \_ Soft Pink (NCS S 1010-Y50R)
  - 24/ \_ \_ Beige M1 (NCS S 2005-Y50R)
  - 93/ \_ \_ White (RAL 9016)

**Finish customization**  
 (Available options:  
 Vibia colour palette)

**LED temperature colour**  
 /1 \_ 2700 K   
 CRI >90 157 lm 105 lm/W

**Control**  
 7404 \_ \_ / \_ 5  
 Push 430,00 €

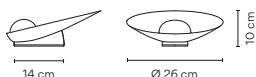

**Materials**

Diffuser: Blown glass.  
 Body: Aluminum.

**Light Source and electronics**

1 x LED 1,5 W 500 mA  
 Constant Voltage 5V  
 100~240V 50/60Hz

**Packaging**

1 Box 0,17 x 0,32 x 0,3 m  
 Vol 0,0163 m<sup>3</sup>  
 Gross weight 1,4 Kg Net weight 0,95 Kg

**Notes**

Portable version with battery.  
 Dimmer switch on the base. 3 step dimming.  
 Electric cable with plug. 3 m.  
 Battery life: from 6 to 18 hours  
 (depending on intensity).



7415

- Finishes**
- 36/ \_ \_ Soft Pink (NCS S 1010-Y50R)
  - 24/ \_ \_ Beige M1 (NCS S 2005-Y50R)
  - 93/ \_ \_ White (RAL 9016)

**Finish customization**  
 (Available options:  
 Vibia colour palette)

**LED temperature colour**  
 /1 \_ 2700 K   
 CRI >90 449 lm 100 lm/W

**Control**  
 7415 \_ \_ / \_ 3  
 1-10V 335,00 €

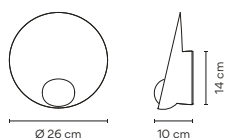

**Materials**

Diffuser: Blown glass.  
 Body: Aluminum.

**Light Source and electronics**

1 x LED 4,5 W 350 mA  
 Constant Current 350 mA  
 220~240V 50/60Hz

**Packaging**

1 Box 0,17 x 0,32 x 0,3 m  
 Vol 0,0163 m<sup>3</sup>  
 Gross weight 1,8 Kg Net weight 1,3 Kg

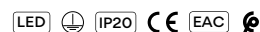

# Knit

Design by Meike Harde

Form, materiality and tangibility collide with the Knit collection. Its texture is magnetic, calling out for us to touch its surface, to feel its warmth and to keep it close. Light seeps outwards through the fabric and downwards through a translucent screen, softening its luminosity.

## Pendants



### 7450

Finishes  
 ● 24/ \_ Beige M1  
 (NCS S 2005-Y50R)

LED temperature colour  
 /1\_ 2700 K   
 CRI >90 7470 lm 133,9 lm/W

Control  
 7450 \_ \_ / \_ 1      1.455,00 €  
 DALI  
 7450 \_ \_ / \_ 3      1.335,00 €  
 1-10V  
 7450 \_ \_ / \_ Z      1.455,00 €  
 Casambi

Electrical connection  
 Surface  
 \_18 Free Wire  
 \_23 Built-in  
 \_31 Remote  
 Micro  
 for plaster  
 ceilings  
 \_32 Remote  
 XXS  
 for all types  
 of drop  
 ceilings

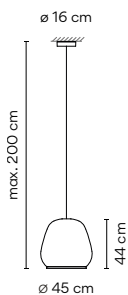

Materials  
 Fabric shade: Polyester flame retardant.  
 Shade: Polyethylene. Difuser: Methacrylate.  
 Difuser ring: ABS.

Light Source and electronics  
 6 x LED 5,9W 350 mA  
 Constant Current 1050 mA  
 110~240V 50/60Hz

Packaging  
 1 Box 0,55 x 0,55 x 0,65 m  
 Vol 0,196 m<sup>3</sup>  
 Gross weight 6 Kg Net weight 3,7 Kg

Notes  
 Extra cable length. 16,00 €/m

LED IP20 CE EAC Bi-volt

1160 | 10 | /1A | \_18

Model | Finish | LED temperature colour | Control | Electrical connection | Only for pendants



7455

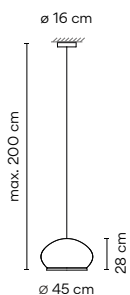

Finishes  
● 24/ \_ Beige M1  
(NCS S 2005-Y50R)

LED temperature colour  
/1\_ 2700 K   
CRI >90 7470 lm 133,9 lm/W

| Control                   | Price      |
|---------------------------|------------|
| 7455 _ _ / _ 1<br>DALI    | 1.350,00 € |
| 7455 _ _ / _ 3<br>1-10V   | 1.285,00 € |
| 7455 _ _ / _ Z<br>Casambi | 1.405,00 € |

Materials  
Fabric shade: Polyester flame retardant.  
Shade: Polyethylene. Difuser: Methacrylate.  
Difuser ring: ABS.

Light Source and electronics  
6 x LED 5,9W 350 mA  
Constant Current 1050 mA  
110-240V 50/60Hz

Packaging  
1 Box 0,54 x 0,54 x 0,41 m  
Vol 0,119 m<sup>3</sup>  
Gross weight 5,9 Kg Net weight 3,2Kg

Notes  
Extra cable length. 16,00 €/m

Electrical connection  
\_18 Surface  
\_18 Free Wire  
\_23 Built-in  
\_31 Remote  
\_31 Remote  
Micro  
for plaster  
ceilings  
\_32 Remote  
XXS  
for all types  
of drop  
ceilings

7460

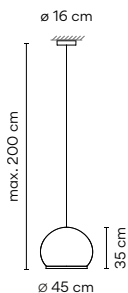

|   |  |  |
|---|--|--|
| <b>Finishes</b>   | <b>LED temperature colour</b>            | <b>Control</b>                                     |
| ● 24/ _ Beige M1<br>(NCS S 2005-Y50R)   | /1_ 2700 K<br>CRI >90 7470 lm 133,9 lm/W | <b>7460 _ _ / _ 1</b> <b>1.385,00 €</b><br>DALI    |
|   |  | <b>7460 _ _ / _ 3</b> <b>1.315,00 €</b><br>1-10V   |
|   |  | <b>7460 _ _ / _ Z</b> <b>1.435,00 €</b><br>Casambi |
| <b>Materials</b>  |  |  |
| Fabric shade: Polyester flame retardant<br>Shade: Polyethylene Difuser: Methacrylate.<br>Difuser ring: ABS. |  |  |
| <b>Light Source and electronics</b>   |  |  |
| 6 x LED 5,9W 350 mA<br>Constant Current 1050 mA<br>110-240V 50/60Hz   |  |  |
| <b>Packaging</b>  |  |  |
| 1 Box 0,54 x 0,54 x 0,41 m<br>Vol 0,119 m <sup>3</sup><br>Gross weight 5,2 Kg Net weight 3,4Kg              |  |  |
| <b>Notes</b>  |  |  |
| Extra cable length. <b>16,00 €/m</b>  |  |  |
|   |  |  |

**Electrical connection**

Surface

**\_18** Free Wire

**\_23** Built-in

**\_31** Remote

Micro for plaster ceilings

**\_32** Remote XXS for all types of drop ceilings

7470

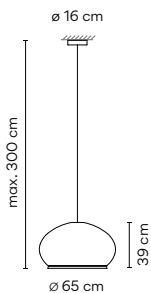

|  |  |  |
|--|--|--|
| <b>Finishes</b>  | <b>LED temperature colour</b>            | <b>Control</b>                                     |
| ● 24/ _ Beige M1<br>(NCS S 2005-Y50R)  | /1_ 2700 K<br>CRI >90 7470 lm 133,9 lm/W | <b>7470 _ _ / _ 1</b> <b>1.590,00 €</b><br>DALI    |
|  |  | <b>7470 _ _ / _ 3</b> <b>1.510,00 €</b><br>1-10V   |
|  |  | <b>7470 _ _ / _ Z</b> <b>1.630,00 €</b><br>Casambi |
| <b>Materials</b>   |  |  |
| Fabric shade: Polyester flame retardant.<br>Shade: Polyethylene Difuser: Methacrylate.<br>Difuser ring: ABS. |  |  |
| <b>Light Source and electronics</b>  |  |  |
| 6 x LED 6,7W 400 mA<br>Constant Current 1200 mA<br>110-240V 50/60Hz  |  |  |
| <b>Packaging</b>   |  |  |
| 1 Box 0,59 x 0,78 x 0,78m<br>Vol 0,358 m <sup>3</sup><br>Gross weight 9Kg Net weight 5,5Kg                   |  |  |
| <b>Notes</b>   |  |  |
| Extra cable length. <b>16,00 €/m</b>   |  |  |
|  |  |  |

**Electrical connection**

Surface

**\_18** Free Wire

**\_23** Built-in

**\_31** Remote

Micro for plaster ceilings

**\_32** Remote XXS for all types of drop ceilings

7475

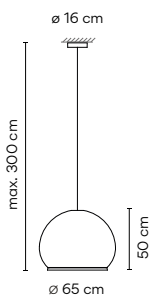

|   |  |  |
|---|--|--|
| <b>Finishes</b>   | <b>LED temperature colour</b>            | <b>Control</b>                                     |
| ● 24/ _ Beige M1<br>(NCS S 2005-Y50R)   | /1_ 2700 K<br>CRI >90 7470 lm 133,9 lm/W | <b>7475 _ _ / _ 1</b> <b>1.620,00 €</b><br>DALI    |
|   |  | <b>7475 _ _ / _ 3</b> <b>1.540,00 €</b><br>1-10V   |
|   |  | <b>7475 _ _ / _ Z</b> <b>1.660,00 €</b><br>Casambi |
| <b>Materials</b>  |  |  |
| Fabric shade: Polyester flame retardant<br>Shade: Polyethylene Difuser: Methacrylate.<br>Difuser ring: ABS. |  |  |
| <b>Light Source and electronics</b>   |  |  |
| 6 x LED 6,7W 400 mA<br>Constant Current 1200 mA<br>110-240V 50/60Hz   |  |  |
| <b>Packaging</b>  |  |  |
| 1 Box 0,80 x 0,80 x 0,77m<br>Vol 0,492 m <sup>3</sup><br>Gross weight 9,5Kg Net weight 6Kg                  |  |  |
| <b>Notes</b>  |  |  |
| Extra cable length. <b>16,00 €/m</b>  |  |  |
|   |  |  |

**Electrical connection**

Surface

**\_18** Free Wire

**\_23** Built-in

**\_31** Remote

Micro for plaster ceilings

**\_32** Remote XXS for all types of drop ceilings



# Electrical connection options for models 7450 / 7455 / 7460 / 7470 / 7475

Choose your preferred installation option according to your needs. For each composition, the optimal minimum number of drivers will be delivered.

## Drop ceiling

The innovative remote and built-in fittings accentuate the silkiness and lightness of compositions on suspended ceilings, its great visual grandeur taking center stage.

For Ref. 7450 / 7455 / 7460 / 7470 / 7475

### Remote

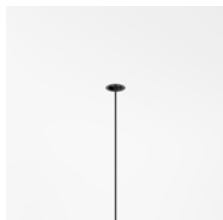

**Micro**  $\varnothing$  3 cm  
height 7 cm  
for plaster ceilings.  
Black finish.

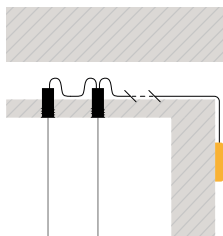

**XXS**  $\varnothing$  6 cm  
height 6 cm  
for all types of drop  
ceilings. Match with  
fixture finish.



### Built-in



$\varnothing$  8 cm  
height 6 cm  
match with  
fixture finish.

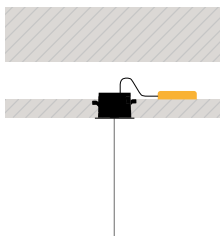



---

## Regular ceiling

When architecture does not allow for performance, surface and free wire showcase possibilities for any need or desire with no limits, ideal for both individual or cluster arrangements.

For Ref. 7450 / 7455 / 7460 / 7470 / 7475

### Surface



ø 16 cm

match with  
fixture finish.

### Free Wire



1 wire

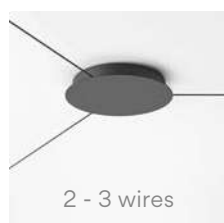

2 - 3 wires



4 wires

ø 22 cm

ø 36 cm

ø 40 cm

you can choose the finish of the canopy  
among black, white or any colour  
matching one of the pendants.

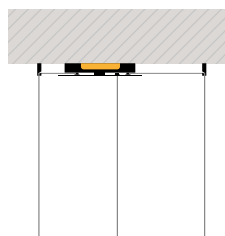
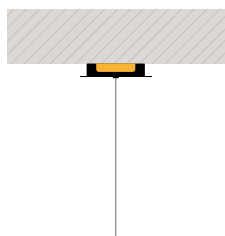

Floor



ø 45 cm

ø 65 cm

ø 65 cm



7480

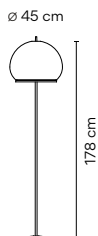

Finishes **24/ \_ \_ Beige M1**  
 (NCS S 2005-Y50R)

LED temperature colour **/1 \_ 2700 K**   
 CRI >90 4740 lm 133,9 lm/W

Control **7480 \_ \_ / \_ 5** **1.645,00 €**  
 Push

**7480 \_ \_ / \_ Z** **1.765,00 €**  
 Casambi

Materials  
 Fabric shade: Textile. Shade: Polyethylene.  
 Difuser: Methacrylate. Difuser ring: ABS Tube: Iron steel.  
 Base: Zamak.

Light Source and electronics  
 6 x LED 5,9W 350 mA  
 Constant Voltage 42V 1,43mA  
 110-240V 50/60Hz

Packaging  
 2 Boxes  
 Box 1: 0,54 x 0,54 x 0,41 m  
 Box 2: 1,71 x 0,38 x 0,36 m  
 Total Vol. 0,353 m<sup>3</sup>  
 Gross weight 21,9 Kg Net weight 11,3 Kg

Notes  
 Electric cable 2,5 m

7485

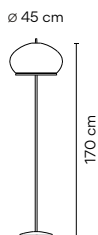

Finishes **24/ \_ \_ Beige M1**  
 (NCS S 2005-Y50R)

LED temperature colour **/1 \_ 2700 K**   
 CRI >90 4740 lm 133,9 lm/W

Control **7485 \_ \_ / \_ 5** **1.695,00 €**  
 Push

**7485 \_ \_ / \_ Z** **1.815,00 €**  
 Casambi

Materials  
 Fabric shade: Textile. Shade: Polyethylene.  
 Difuser: Methacrylate. Difuser ring: ABS Tube: Iron steel.  
 Base: Zamak.

Light Source and electronics  
 6 x LED 5,9W 350 mA  
 Constant Voltage 42V 1,43mA  
 110-240V 50/60Hz

Packaging  
 2 Boxes  
 Box 1: 0,54 x 0,54 x 0,41 m  
 Box 2: 1,71 x 0,38 x 0,36 m  
 Total Vol. 0,353m<sup>3</sup>  
 Gross weight 21,5Kg Net weight 10,8Kg

Notes  
 Electric cable 2,5 m

7487

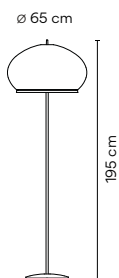

Finishes **24/ \_ \_ Beige M1**  
 (NCS S 2005-Y50R)

LED temperature colour **/1 \_ 2700 K**   
 CRI >90 4740 lm 133,9 lm/W

Control **7487 \_ \_ / \_ 5** **2.055,00 €**  
 Push

**7487 \_ \_ / \_ Z** **2.175,00 €**  
 Casambi

Materials  
 Fabric shade: Textile. Shade: Polyethylene.  
 Difuser: Methacrylate. Difuser ring: ABS Tube: Iron steel.  
 Base: Zamak.

Light Source and electronics  
 6 x LED 5,9W 350 mA  
 Constant Voltage 42V 1,43 mA  
 110-240V 50/60Hz

Packaging  
 2 Boxes  
 Box 1: 0,78 x 0,78 x 0,59 m  
 Box 2: 1,93 x 0,45 x 0,46 m  
 Total Vol. 0,7579 m<sup>3</sup>  
 Gross weight 30 Kg Net weight 18,5 Kg

Notes  
 Electric cable 2,5 m

|             |  |  |  |
|-------------|--|--|--|
| <b>7490</b> | <b>Finishes</b>                                | <b>LED temperature colour</b>  | <b>Control</b>                                     |
|             | ● <b>24/ _ _ Beige M1</b><br>(NCS S 2005-Y50R) | <b>/1 _ 2700 K</b> <br>CRI >90 4740 lm 133,9 lm/W | <b>7490 _ _ / _ 5</b> <b>1.305,00 €</b><br>Push    |
|             |  |  | <b>7490 _ _ / _ Z</b> <b>1.425,00 €</b><br>Casambi |

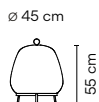

**Materials**

Fabric shade: Textile Shade: Polyethylene.  
Difuser: Methacrylate. Difuser ring: ABS.  
Support: ABS.

**Light Source and electronics**

6 x LED 5,9 W 350 mA  
Constant Voltage 42V 1,43 mA  
110-240V 50/60Hz

**Packaging**

1 Box 0,65 x 0,55 x 0,55 m  
Vol 0,196 m<sup>3</sup>  
Gross Weight 5,4 Kg Net Weight 3,3 Kg

**Notes**

Electric cable 2,5 m



|             |  |  |  |
|-------------|--|--|--|
| <b>7492</b> | <b>Finishes</b>                                | <b>LED temperature colour</b>  | <b>Control</b>                                     |
|             | ● <b>24/ _ _ Beige M1</b><br>(NCS S 2005-Y50R) | <b>/1 _ 2700 K</b> <br>CRI >90 4740 lm 133,9 lm/W | <b>7492 _ _ / _ 5</b> <b>1.490,00 €</b><br>Push    |
|             |  |  | <b>7492 _ _ / _ Z</b> <b>1.610,00 €</b><br>Casambi |

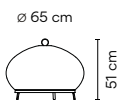

**Materials**

Fabric shade: Textile. Shade: Polyethylene.  
Difuser: Methacrylate. Difuser ring: ABS.  
Support: ABS.

**Light Source and electronics**

6 x LED 5,9 W 350 mA  
Constant Voltage 42V 1,43 mA  
110-240V 50/60Hz

**Packaging**

1 Box 0,78 x 0,78 x 0,59 m  
Vol 0,358 m<sup>3</sup>  
Gross Weight 7,3 Kg Net Weight 4,5 Kg

**Notes**

Electric cable 2,5 m



|             |  |  |  |
|-------------|--|--|--|
| <b>7494</b> | <b>Finishes</b>                                | <b>LED temperature colour</b>  | <b>Control</b>                                     |
|             | ● <b>24/ _ _ Beige M1</b><br>(NCS S 2005-Y50R) | <b>/1 _ 2700 K</b> <br>CRI >90 4740 lm 133,9 lm/W | <b>7494 _ _ / _ 5</b> <b>1.540,00 €</b><br>Push    |
|             |  |  | <b>7494 _ _ / _ Z</b> <b>1.660,00 €</b><br>Casambi |

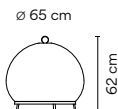

**Materials**

Fabric shade: Textile. Shade: Polyethylene.  
Difuser: Methacrylate. Difuser ring: ABS.  
Support: ABS.

**Light Source and electronics**

6 x LED 5,9 W 350 mA  
Constant Voltage 42V 1,43 mA  
110-240V 50/60Hz

**Packaging**

1 Box 0,80 x 0,80 x 0,75 m  
Vol 0,48 m<sup>3</sup>  
Gross weight 9,3 Kg Net weight 5,9 Kg

**Notes**

Electric cable 2,5 m



1160 10 /1A  
Model Finish  
LED temperature colour  
Control



# Set

Design by Xuclà

A game of light, shadows and volumes, Set is a new concept of modular wall sconces that composes light as art onto the walls. During the day Set decorates the wall with a pattern of rectangular elements, but once illuminated it creates a surprising feature of lights, shadows and volumes.



Each project is unique. Visit [vibia.com](http://vibia.com) and chose among multiple compositions designed and adapted to your project needs.

Personalise your own Set composition quick and easy at [vibia.com](http://vibia.com)

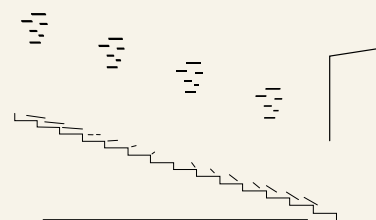
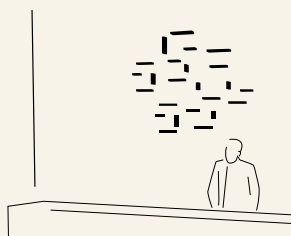
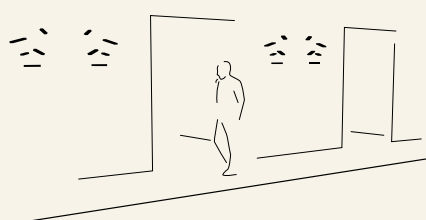

7753 x 3  
 1.245,00 €



7753 x 3  
 1.245,00 €

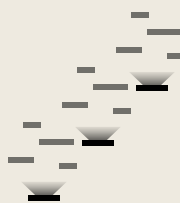

7750 x 1, 7751 x 3, 7752 x 1  
 1.510,00 €



7760 x 1, 7761 x 1, 7762 x 2,  
 7763 x 1, 7764 x 1  
 2.800,00 €

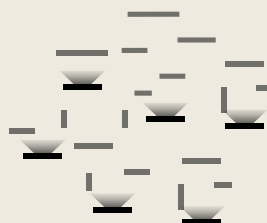

|             |  |  |                                |
|-------------|--|--|--------------------------------|
| <b>7749</b> | <b>Finishes</b>  | <b>LED temperature colour</b>  | <b>Control</b>                 |
|             | <ul style="list-style-type: none"> <li>● <b>59/</b> __ Mink (PANTONE 407)</li> <li>● <b>93/</b> __ White (RAL 9003)</li> </ul> | <b>/1</b> 2700 K <br>CRI >90 1269 lm 141 lm/W | <b>7749</b> __ / __ 2<br>0-10V |

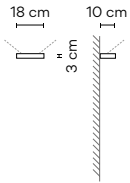
**Materials**

Body: Aluminum. Diffuser: Borosilicate glass.  
Lid: Polycarbonate.

**Light Source and electronics**

1 x LED 9 W 350 mA  
Constant Current 350 mA  
100~240V 50/60Hz

**Packaging**

1 Box 0,065 x 0,145 x 0,275 m  
Vol 0,0026 m<sup>3</sup>  
Gross weight 0,67 Kg Net weight 0,52 Kg

**Notes**

LED placed on the lower element.  
Small

|             |  |  |                                |
|-------------|--|--|--------------------------------|
| <b>7750</b> | <b>Finishes</b>  | <b>LED temperature colour</b>  | <b>Control</b>                 |
|             | <ul style="list-style-type: none"> <li>● <b>59/</b> __ Mink (PANTONE 407)</li> <li>● <b>93/</b> __ White (RAL 9003)</li> </ul> | <b>/1</b> 2700 K <br>CRI >90 1269 lm 141 lm/W | <b>7750</b> __ / __ 2<br>0-10V |

**Materials**

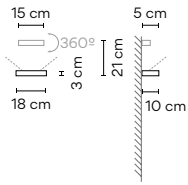
Body: Aluminum. Diffuser: Borosilicate glass.  
Reflector body: Foamed PVC. Lid: Polycarbonate.

**Light Source and electronics**

1 x LED 9 W 350 mA  
Constant Current 350 mA  
100~240V 50/60Hz

**Packaging**

1 Box 0,15 x 0,132 x 0,36 m  
Vol 0,0071 m<sup>3</sup>  
Gross weight 0,95 Kg Net weight 0,8 Kg

**Notes**

LED placed on the lower element.  
Small

|             |  |  |                                |
|-------------|--|--|--------------------------------|
| <b>7751</b> | <b>Finishes</b>  | <b>LED temperature colour</b>  | <b>Control</b>                 |
|             | <ul style="list-style-type: none"> <li>● <b>59/</b> __ Mink (PANTONE 407)</li> <li>● <b>93/</b> __ White (RAL 9003)</li> </ul> | <b>/1</b> 2700 K <br>CRI >90 1269 lm 141 lm/W | <b>7751</b> __ / __ 2<br>0-10V |

**Materials**

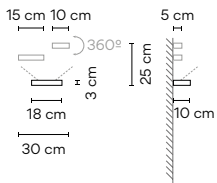
Body: Aluminum. Diffuser: Borosilicate glass.  
Reflector body: Foamed PVC. Lid: Polycarbonate.

**Light Source and electronics**

1 x LED 9 W 350 mA  
Constant Current 350 mA  
100~240V 50/60Hz

**Packaging**

1 Box 0,15 x 0,132 x 0,36 m  
Vol 0,0071 m<sup>3</sup>  
Gross weight 1,25 Kg Net weight 1,1 Kg

**Notes**

LED placed on the lower element.  
Small

|             |  |  |                                |
|-------------|--|--|--------------------------------|
| <b>7752</b> | <b>Finishes</b>  | <b>LED temperature colour</b>  | <b>Control</b>                 |
|             | <ul style="list-style-type: none"> <li>● <b>59/</b> __ Mink (PANTONE 407)</li> <li>● <b>93/</b> __ White (RAL 9003)</li> </ul> | <b>/1</b> 2700 K <br>CRI >90 1269 lm 141 lm/W | <b>7752</b> __ / __ 2<br>0-10V |

**Materials**

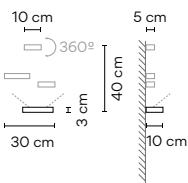
Body: Aluminum. Diffuser: Borosilicate glass.  
Reflector body: Foamed PVC. Lid: Polycarbonate.

**Light Source and electronics**

1 x LED 9 W 350 mA  
Constant Current 350 mA  
100~240V 50/60Hz

**Packaging**

1 Box 0,15 x 0,132 x 0,36 m  
Vol 0,0071 m<sup>3</sup>  
Gross weight 1,6 Kg Net weight 1,4 Kg

**Notes**

LED placed on the lower element.  
Small



7753

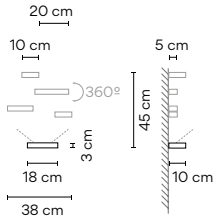

|   |   |  |                 |
|---|---|--|-----------------|
| <b>Finishes</b><br>● 59/ __ Mink (PANTONE 407)<br>● 93/ __ White (RAL 9003) | <b>LED temperature colour</b><br>/1_ 2700 K<br>CRI >90 1269 lm 141 lm/W | <b>Control</b><br>7753 __ / _ 2<br>0-10V | <b>415,00 €</b> |
|---|---|--|-----------------|

**Materials**  
 Body: Aluminum. Diffuser: Borosilicate glass.  
 Reflector body: Foamed PVC. Lid: Polycarbonate.

**Light Source and electronics**  
 1 x LED 9 W 350 mA  
 Constant Current 350 mA  
 100~240V 50/60Hz

**Packaging**  
 1 Box 0,15 x 0,193 x 0,36 m  
 Vol 0,0100 m<sup>3</sup>  
 Gross weight 2 Kg Net weight 1,5 Kg

**Notes**  
 LED placed on the lower element.  
 Small



7759

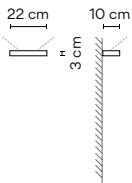

|   |   |  |                 |
|---|---|--|-----------------|
| <b>Finishes</b><br>● 59/ __ Mink (PANTONE 407)<br>● 93/ __ White (RAL 9003) | <b>LED temperature colour</b><br>/1_ 2700 K<br>CRI >90 1269 lm 141 lm/W | <b>Control</b><br>7759 __ / _ 2<br>0-10V | <b>285,00 €</b> |
|---|---|--|-----------------|

**Materials**  
 Body: Aluminum. Diffuser: Borosilicate glass.  
 Lid: Polycarbonate.

**Light Source and electronics**  
 1 x LED 9 W 350 mA  
 Constant Current 350 mA  
 100~240V 50/60Hz

**Packaging**  
 1 Box 0,065 x 0,145 x 0,275 m  
 Vol 0,0026 m<sup>3</sup>  
 Gross weight 0,75 Kg Net weight 0,6 Kg

**Notes**  
 LED placed on the lower element.  
 Big.

UNTIL STOCK RUNS OUT



7760

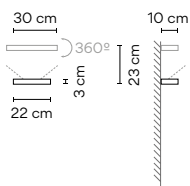

|   |   |  |                 |
|---|---|--|-----------------|
| <b>Finishes</b><br>● 59/ __ Mink (PANTONE 407)<br>● 93/ __ White (RAL 9003) | <b>LED temperature colour</b><br>/1_ 2700 K<br>CRI >90 1269 lm 141 lm/W | <b>Control</b><br>7760 __ / _ 2<br>0-10V | <b>360,00 €</b> |
|---|---|--|-----------------|

**Materials**  
 Body: Aluminum. Diffuser: Borosilicate glass.  
 Reflector body: Foamed PVC. Lid: Polycarbonate.

**Light Source and electronics**  
 1 x LED 9 W 350 mA  
 Constant Current 350 mA  
 100~240V 50/60Hz

**Packaging**  
 1 Box 0,15 x 0,132 x 0,36 m  
 Vol 0,0071 m<sup>3</sup>  
 Gross weight 1,4 Kg Net weight 1,1 Kg

**Notes**  
 LED placed on the lower element.  
 Big.

UNTIL STOCK RUNS OUT



7761

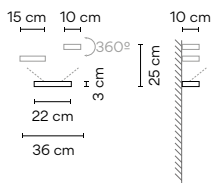

|   |   |  |                 |
|---|---|--|-----------------|
| <b>Finishes</b><br>● 59/ __ Mink (PANTONE 407)<br>● 93/ __ White (RAL 9003) | <b>LED temperature colour</b><br>/1_ 2700 K<br>CRI >90 1269 lm 141 lm/W | <b>Control</b><br>7761 __ / _ 2<br>0-10V | <b>410,00 €</b> |
|---|---|--|-----------------|

**Materials**  
 Body: Aluminum. Diffuser: Borosilicate glass.  
 Reflector body: Foamed PVC. Lid: Polycarbonate.

**Light Source and electronics**  
 1 x LED 9 W 350 mA  
 Constant Current 350 mA  
 100~240V 50/60Hz

**Packaging**  
 1 Box 0,15 x 0,132 x 0,36 m  
 Vol 0,0071 m<sup>3</sup>  
 Gross weight 1,5 Kg Net weight 1,2 Kg

**Notes**  
 LED placed on the lower element.  
 Big.

UNTIL STOCK RUNS OUT



|             |  |  |                               |
|-------------|--|--|-------------------------------|
| <b>7762</b> | <b>Finishes</b>  | <b>LED temperature colour</b>  | <b>Control</b>                |
|             | <ul style="list-style-type: none"> <li>● <b>59/</b> __ Mink (PANTONE 407)</li> <li>● <b>93/</b> __ White (RAL 9003)</li> </ul> | <b>/1</b> _ 2700 K <br>CRI >90 1269 lm 141 lm/W | <b>7762</b> __ / _ 2<br>0-10V |

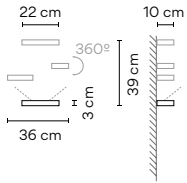

**Materials**  
 Body: Aluminum. Diffuser: Borosilicate glass.  
 Reflector body: Foamed PVC. Lid: Polycarbonate.

**Light Source and electronics**  
 1 x LED 9 W 350 mA  
 Constant Current 350 mA  
 100~240V 50/60Hz

**Packaging**  
 1 Box 0,15 x 0,193 x 0,36 m  
 Vol 0,0100 m<sup>3</sup>  
 Gross weight 1,9 Kg Net weight 1,9 Kg

**Notes**  
 LED placed on the lower element.  
 Big.

**UNTIL STOCK RUNS OUT**

|             |  |  |                               |
|-------------|--|--|-------------------------------|
| <b>7763</b> | <b>Finishes</b>  | <b>LED temperature colour</b>  | <b>Control</b>                |
|             | <ul style="list-style-type: none"> <li>● <b>59/</b> __ Mink (PANTONE 407)</li> <li>● <b>93/</b> __ White (RAL 9003)</li> </ul> | <b>/1</b> _ 2700 K <br>CRI >90 1269 lm 141 lm/W | <b>7763</b> __ / _ 2<br>0-10V |

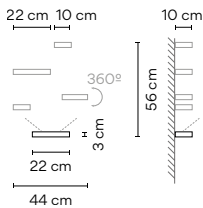

**Materials**  
 Body: Aluminum. Diffuser: Borosilicate glass.  
 Reflector body: Foamed PVC. Lid: Polycarbonate.

**Light Source and electronics**  
 1 x LED 9 W 350 mA  
 Constant Current 350 mA  
 100~240V 50/60Hz

**Packaging**  
 1 Box 0,15 x 0,193 x 0,36 m  
 Vol 0,0100 m<sup>3</sup>  
 Gross weight 2,25 Kg Net weight 1,75 Kg

**Notes**  
 LED placed on the lower element.  
 Big.

**UNTIL STOCK RUNS OUT**

|             |  |  |                               |
|-------------|--|--|-------------------------------|
| <b>7764</b> | <b>Finishes</b>  | <b>LED temperature colour</b>  | <b>Control</b>                |
|             | <ul style="list-style-type: none"> <li>● <b>59/</b> __ Mink (PANTONE 407)</li> <li>● <b>93/</b> __ White (RAL 9003)</li> </ul> | <b>/1</b> _ 2700 K <br>CRI >90 1269 lm 141 lm/W | <b>7764</b> __ / _ 2<br>0-10V |

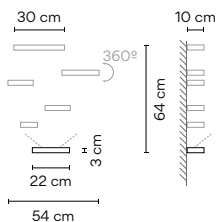

**Materials**  
 Body: Aluminum. Diffuser: Borosilicate glass.  
 Reflector body: Foamed PVC. Lid: Polycarbonate.

**Light Source and electronics**  
 1 x LED 9 W 350 mA  
 Constant Current 350 mA  
 100~240V 50/60Hz

**Packaging**  
 1 Box 0,15 x 0,193 x 0,36 m  
 Vol 0,0100 m<sup>3</sup>  
 Gross weight 2,75 Kg Net weight 2,25 Kg

**Notes**  
 LED placed on the lower element.  
 Big.

**UNTIL STOCK RUNS OUT**

1160 | 10 | /1A  
Model | Finish |  
LED temperature colour |  
Control |



# Alpha

Design by Ramos & Bassols

An embedded light breaking free to serve.

## Wall



∅ 10,5 cm

7920



8 cm

7925



5 cm

7930



10,5 cm

7935



12 x 12 cm

7940 7942\*



24 cm

7955



14 x 24 cm

7950

### 7920

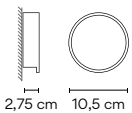

- Finishes
- 03/ \_\_ White and chrome (RAL 9016)
  - 04/ \_\_ Black and chrome (RAL 9005)
  - 18/ \_\_ Graphite and black (RAL 7016)
  - 93/ \_\_ White (RAL 9016)

LED temperature colour  
/1\_ 2700 K   
CRI >90 181,2 lm 86 lm/W

Control  
7920 \_\_ / \_ 0  
On/ Off

255,00 €

#### Materials

Box: Zamak. Diffuser: Polycarbonate.  
Lid: Steel.

#### Light Source and electronics

1 x LED 2,1 W 700 mA  
Constant Current 700 mA  
100~240V 50/60Hz

#### Packaging

1 Box 0,13 x 0,20 x 0,21 m  
Vol 0,0055 m<sup>3</sup>  
Gross weight 1 Kg Net weight 0,444 Kg

#### Notes

Surface.

**UNTIL STOCK RUNS OUT**

LED  IP20    Bi-volt

7925

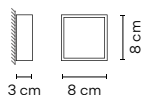

|  |  |   |                        |
|--|--|---|------------------------|
| <p><b>Finishes</b></p> <ul style="list-style-type: none"> <li>● 03/ __ White and chrome (RAL 9016)</li> <li>● 04/ __ Black and chrome (RAL 9005)</li> <li>● 18/ __ Graphite and black (RAL 7016)</li> <li>● 93/ __ White (RAL 9016)</li> </ul> | <p><b>LED temperature colour</b></p> <p>/1 _ 2700 K  <b>G</b><br/>       CRI &gt;90 181,2 lm 86 lm/W</p> | <p><b>Control</b></p> <p>7925 __ / _ 0<br/>       On/ Off</p> | <p><b>255,00 €</b></p> |
|--|--|---|------------------------|

|  |  |
|--|--|
| <p><b>Materials</b></p> <p>Box: Zamak. Diffuser: Polycarbonate.<br/>       Lid: Steel.</p> <p><b>Light Source and electronics</b></p> <p>1 x LED 2,1 W 700 mA<br/>       Constant Current 700 mA<br/>       100~240V 50/60Hz</p> | <p><b>Packaging</b></p> <p>1 Box 0,13 x 0,21 x 0,20 m<br/>       Vol 0,0055 m<sup>3</sup><br/>       Gross weight 1 Kg Net weight 0,32 Kg</p> <p><b>Notes</b></p> <p>Surface.<br/> <b>UNTIL STOCK RUNS OUT</b></p> |
|--|--|



7930

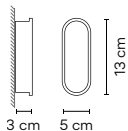

|  |  |   |                        |
|--|--|---|------------------------|
| <p><b>Finishes</b></p> <ul style="list-style-type: none"> <li>● 03/ __ White and chrome (RAL 9016)</li> <li>● 04/ __ Black and chrome (RAL 9005)</li> <li>● 18/ __ Graphite and black (RAL 7016)</li> <li>● 93/ __ White (RAL 9016)</li> </ul> | <p><b>LED temperature colour</b></p> <p>/1 _ 2700 K  <b>G</b><br/>       CRI &gt;90 181,2 lm 86 lm/W</p> | <p><b>Control</b></p> <p>7930 __ / _ 0<br/>       On/ Off</p> | <p><b>290,00 €</b></p> |
|--|--|---|------------------------|

|  |   |
|--|---|
| <p><b>Materials</b></p> <p>Box: Zamak. Diffuser: Polycarbonate.<br/>       Lid: Steel.</p> <p><b>Light Source and electronics</b></p> <p>2 x LED 2,1 W 700 mA<br/>       Constant Current 700 mA<br/>       100~240V 50/60Hz</p> | <p><b>Packaging</b></p> <p>1 Box 0,13 x 0,20 x 0,21 m<br/>       Vol 0,0055 m<sup>3</sup><br/>       Gross weight 0,9 Kg Net weight 0,3 Kg</p> <p><b>Notes</b></p> <p>Surface.<br/> <b>UNTIL STOCK RUNS OUT</b></p> |
|--|---|



7935

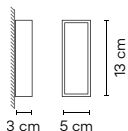

|  |  |   |                        |
|--|--|---|------------------------|
| <p><b>Finishes</b></p> <ul style="list-style-type: none"> <li>● 03/ __ White and chrome (RAL 9016)</li> <li>● 04/ __ Black and chrome (RAL 9005)</li> <li>● 18/ __ Graphite and black (RAL 7016)</li> <li>● 93/ __ White (RAL 9016)</li> </ul> | <p><b>LED temperature colour</b></p> <p>/1 _ 2700 K  <b>G</b><br/>       CRI &gt;90 362,4 lm 86 lm/W</p> | <p><b>Control</b></p> <p>7935 __ / _ 0<br/>       On/ Off</p> | <p><b>290,00 €</b></p> |
|--|--|---|------------------------|

|  |   |
|--|---|
| <p><b>Materials</b></p> <p>Box: Zamak. Diffuser: Polycarbonate.<br/>       Lid: Steel.</p> <p><b>Light Source and electronics</b></p> <p>2 x LED 2,1 W 700 mA<br/>       Constant Current 700 mA<br/>       100~240V 50/60Hz</p> | <p><b>Packaging</b></p> <p>1 Box 0,13 x 0,20 x 0,21 m<br/>       Vol 0,0055 m<sup>3</sup><br/>       Gross weight 0,9 Kg Net weight 0,3 Kg</p> <p><b>Notes</b></p> <p>Surface.<br/> <b>UNTIL STOCK RUNS OUT</b></p> |
|--|---|



**7940**

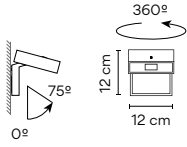

**Finishes**

- **03/** \_\_ White and chrome (RAL 9016)
- **04/** \_\_ Black and chrome (RAL 9005)
- **18/** \_\_ Graphite and black (RAL 7016)
- **93/** \_\_ White (RAL 9016)

**LED temperature colour**

**/1** 2700 K  CRI >90 181,22 lm 86 lm/W

**Control**

**7940** \_\_ / \_\_ **0** 295,00 €  
On/ Off





---

**Materials**  
Diffuser: Polycarbonate. Lid: Zamak.  
Body: Aluminum. Lid: Aluminum.

**Light Source and electronics**  
1 x LED 2,1 W 700 mA  
Constant Current 700 mA  
100~240V 50/60Hz

**Packaging**  
1 Box 0,13 x 0,20 x 0,20 m  
Vol 0,0055 m<sup>3</sup>  
Gross weight 1,2 Kg Net weight 1 Kg

**Notes**  
Surface  
On/off switch on the front cover

LED  IP20    Bi-volt

**7942**



**Finishes**

- **03/** \_\_ White and chrome (RAL 9016)
- **04/** \_\_ Black and chrome (RAL 9005)
- **18/** \_\_ Graphite and black (RAL 7016)
- **93/** \_\_ White (RAL 9016)

**LED temperature colour**

**/1** 2700 K  CRI >90 181,22 lm 86 lm/W

**Control**

**7942** \_\_ / \_\_ **0** 295,00 €  
On/ Off



---

**Materials**  
Diffuser: Polycarbonate. Lid: Zamak.  
Body: Aluminum. Lid: Aluminum.

**Light Source and electronics**  
1 x LED 2,1 W 700 mA  
Constant Current 700 mA  
100~240V 50/60Hz

**Packaging**  
1 Box 0,13 x 0,20 x 0,20 m  
Vol 0,0055 m<sup>3</sup>  
Gross weight 1,2 Kg Net weight 1 Kg

**Notes**  
Surface  
Without switch

LED  IP20    Bi-volt



7950

- Finishes
- 03/ \_ \_ White and chrome (RAL 9016)
  - 04/ \_ \_ Black and chrome (RAL 9005)

LED temperature colour  
 /1\_ 2700 K   
 CRI >90 543,6 lm 86 lm/W

Control  
 7950 \_ \_ / \_ 0  
 On/ Off

370,00 €

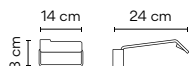

Materials

Diffuser: Polycarbonate. Lid: Zamak.  
 Body: Aluminum. Lid: Aluminum.

Light Source and electronics

3 x LED 2,1 W 700 mA  
 Constant Current 700 mA  
 100~240V 50/60Hz

Packaging

1 Box 0,26 x 0,26 x 0,26 m  
 Vol 0,0175 m<sup>3</sup>  
 Gross weight 1,56 Kg Net weight 0,65 Kg

Notes

Surface  
 Light beam with no IR and UV.

**UNTIL STOCK RUNS OUT**



7955

- Finishes
- 03/ \_ \_ White (RAL 9016)
  - 04/ \_ \_ Black (RAL 9005)

LED temperature colour  
 /1\_ 2700 K   
 CRI >90 543,6 lm 86 lm/W

Control  
 7955 \_ \_ / \_ 0  
 On/ Off

370,00 €

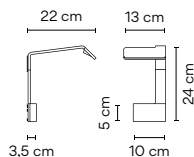

Materials

Diffuser: Polycarbonate. Lid: Zamak.  
 Body: Aluminum. Lid: Aluminum.

Light Source and electronics

3 x LED 2,1 W 700 mA  
 Constant Current 700 mA  
 100~240V 50/60Hz

Packaging

1 Box 0,23 x 0,37 x 0,37 m  
 Vol 0,0310 m<sup>3</sup>  
 Gross weight 0,97 Kg Net weight 0,47 Kg

Notes

Surface  
 Light beam with no IR and UV.

**UNTIL STOCK RUNS OUT**



# Domo

Design by Ramos & Bassols

Featuring a classic cylinder silhouette, Domo offers refined lighting effect, combining diffusion and reflection. The understated, LED-powered fixture has clean lines and a spherical shape that seamlessly blends into the ceiling architecture.

## Ceiling

8200

ø 18,5 cm



8201

ø 18,5 cm



8200

### Finishes

- 03/ \_\_ White (RAL 9010)

### LED temperature colour

- /1\_ 2700 K CRI >90 543,66 lm 86 lm/W
- /2\_ 3000 K CRI >90 489,6 lm 78 lm/W
- /3\_ 3500 K CRI >90 393,6 lm 62,5 lm/W

### Control

- 8200 \_\_ / \_\_ 0 285,00 €  
On / Off
- 8200 \_\_ / \_\_ 2 300,00 €  
0-10V

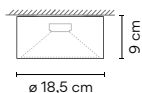

### Materials

Diffuser: Polycarbonate.  
Body: Aluminum.

### Light Source and electronics

3 x LED 2,1 W 700 mA  
Constant Current 700 mA  
100~240V 50/60Hz  
/ \_\_ 0: On/Off, 100~240V Bi-volt  
/ \_\_ 2: 0-10V, 100~277V Multi-volt

### Packaging

1 Box 0,26 x 0,26 x 0,26 m  
Vol 0,0170 m<sup>3</sup>  
Gross weight 1,7 Kg Net weight 1,2 Kg

### Notes

Surface fitting.

**UNTIL STOCK RUNS OUT**

8201

### Finishes

- 03/ \_\_ White (RAL 9010)

### LED temperature colour

- /1\_ 2700 K CRI >90 543,66 lm 86 lm/W
- /2\_ 3000 K CRI >90 489,6 lm 78 lm/W
- /3\_ 3500 K CRI >90 393,6 lm 62,5 lm/W

### Control

- 8201 \_\_ / \_\_ 0 300,00 €  
On / Off
- 8201 \_\_ / \_\_ 2 315,00 €  
0-10V

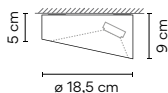

### Materials

Diffuser: Polycarbonate.  
Body: Aluminum.

### Light Source and electronics

3 x LED 2,1 W 700 mA  
Constant Current 700 mA  
100~240V 50/60Hz  
/ \_\_ 0: On/Off, 100~240V Bi-volt  
/ \_\_ 2: 0-10V, 100~277V Multi-volt

### Packaging

1 Box 0,26 x 0,26 x 0,26 m  
Vol 0,0170 m<sup>3</sup>  
Gross weight 1,6 Kg Net weight 1,1 Kg

### Notes

Surface fitting.

**UNTIL STOCK RUNS OUT**





# 45°

Design by Víctor Carrasco

45° fixture features a customised composition of vertical tubes that create a sculptural effect overhead. Suspended from the ceiling like sleek stalagmites, they create an array of glowing accent lighting points.

## Ceiling

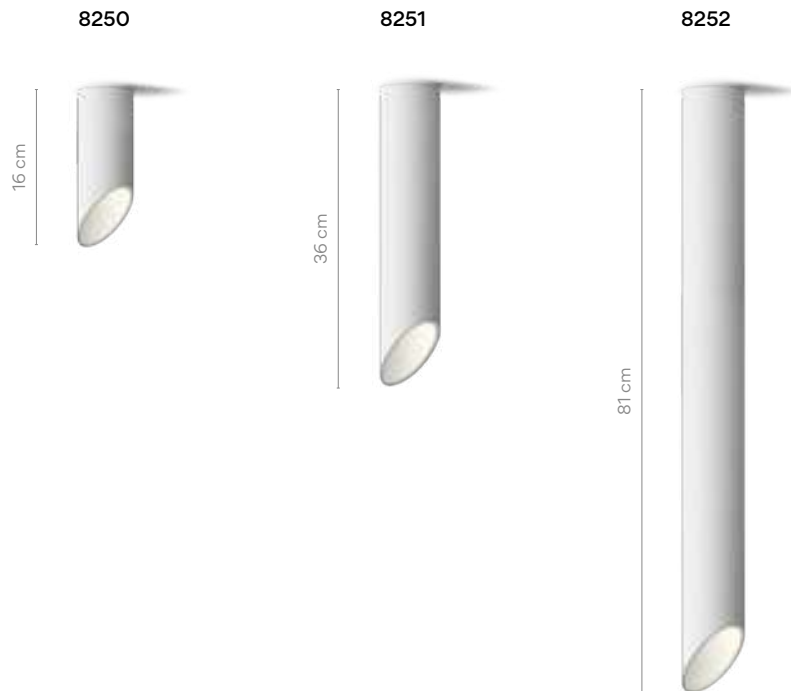

| 8250 | Finishes   | LED temperature colour   | Control   |                      |
|------|--|--|---|----------------------|
|      | <ul style="list-style-type: none"> <li>03/ __ White (RAL 9016)</li> <li>04/ __ Black (RAL 9005)</li> </ul>   | /1 _ 2700 K<br>CRI >90 1352,27 lm 101 lm/W<br>/2 _ 3000 K<br>CRI >90 662 lm 49 lm/W<br>/3 _ 3500 K<br>CRI >90 1463,02 lm 109,18 lm/W   | 8250 __ / _ 3<br>1-10V<br>8250 __ / _ 5<br>Push | 470,00 €<br>495,00 € |
|      | <ul style="list-style-type: none"> <li>52/ __ Black oxide (Satin bronze)</li> </ul>  | /1 _ 2700 K<br>CRI >90 1352,27 lm 101 lm/W<br>/2 _ 3000 K<br>CRI >90 662 lm 49 lm/W<br>/3 _ 3500 K<br>CRI >90 1463,02 lm 109,18 lm/W   | 8250 __ / _ 3<br>1-10V<br>8250 __ / _ 5<br>Push | 525,00 €<br>550,00 € |
|      | <b>Materials</b><br>Diffuser: Polycarbonate.<br>Tube: Aluminum.<br><br><b>Light Source and electronics</b><br>1 x LED 6,1 W 350 mA<br>Constant Current 350 mA<br>230V 50Hz | <b>Packaging</b><br>1 Box 0,21 x 0,21 x 0,48 m<br>Vol 0,0211 m³<br>Gross weight 2,1 Kg Net weight 1,15 Kg<br><br><b>Notes</b><br>Surface fitting.<br>It includes interchangeable diffusers, mink or orange finishes<br><b>UNTIL STOCK RUNS OUT</b> |   |                      |

8251

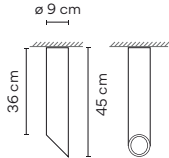

| Finishes                         | LED temperature colour                             | Control                                    |                 |
|----------------------------------|--|--|-----------------|
| ● <b>03/</b> __ White (RAL 9016) | <b>/1</b> _ 2700 K  CRI >90 1352,27 lm 101 lm/W    | <b>8251</b> __ / _ <b>B</b><br>1-10V, Push | <b>510,00 €</b> |
| ● <b>04/</b> __ Black (RAL 9005) | <b>/2</b> _ 3000 K  CRI >90 662 lm 49 lm/W         | <b>8251</b> __ / _ <b>1</b><br>DALI        | <b>540,00 €</b> |
|                                  | <b>/3</b> _ 3500 K  CRI >90 1463,02 lm 109,18 lm/W |  |                 |

| Finishes                                   | LED temperature colour                             | Control                                    |                 |
|--|--|--|-----------------|
| ● <b>52/</b> __ Black oxide (Satin bronze) | <b>/1</b> _ 2700 K  CRI >90 1352,27 lm 101 lm/W    | <b>8251</b> __ / _ <b>B</b><br>1-10V, Push | <b>595,00 €</b> |
|  | <b>/2</b> _ 3000 K  CRI >90 662 lm 49 lm/W         | <b>8251</b> __ / _ <b>1</b><br>DALI        | <b>625,00 €</b> |
|  | <b>/3</b> _ 3500 K  CRI >90 1463,02 lm 109,18 lm/W |  |                 |

Materials

Diffuser: Polycarbonate.  
 Tube: Aluminum.

Light Source and electronics

1 x LED 6,1 W 350 mA  
 Constant Current 350 mA  
 110-240V 50/60Hz

Packaging

1 Box 0,21 x 0,21 x 0,48 m  
 Vol 0,0326 m<sup>3</sup>  
 Gross weight 2,9 Kg Net weight 1,95 Kg

Notes

Surface fitting.  
 It includes interchangeable diffusers,  
 mink or orange finishes

**UNTIL STOCK RUNS OUT**



8252

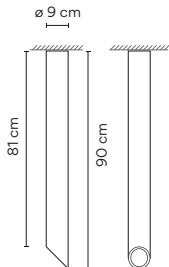

| Finishes                         | LED temperature colour                             | Control                                    |                 |
|----------------------------------|--|--|-----------------|
| ● <b>03/</b> __ White (RAL 9016) | <b>/1</b> _ 2700 K  CRI >90 1352,3 lm 101 lm/W     | <b>8252</b> __ / _ <b>B</b><br>1-10V, Push | <b>750,00 €</b> |
| ● <b>04/</b> __ Black (RAL 9005) | <b>/2</b> _ 3000 K  CRI >90 662 lm 49 lm/W         | <b>8252</b> __ / _ <b>1</b><br>DALI        | <b>790,00 €</b> |
|                                  | <b>/3</b> _ 3500 K  CRI >90 1463,02 lm 109,18 lm/W |  |                 |

| Finishes                                   | LED temperature colour                             | Control                                    |                 |
|--|--|--|-----------------|
| ● <b>52/</b> __ Black oxide (Satin bronze) | <b>/1</b> _ 2700 K  CRI >90 1352,3 lm 101 lm/W     | <b>8252</b> __ / _ <b>B</b><br>1-10V, Push | <b>865,00 €</b> |
|  | <b>/2</b> _ 3000 K  CRI >90 662 lm 49 lm/W         | <b>8252</b> __ / _ <b>1</b><br>DALI        | <b>905,00 €</b> |
|  | <b>/3</b> _ 3500 K  CRI >90 1463,02 lm 109,18 lm/W |  |                 |

Materials

Diffuser: Polycarbonate.  
 Tube: Aluminum.

Light Source and electronics

1 x LED 6,1 W 350 mA  
 Constant Current 350 mA  
 110-240V 50/60Hz

Packaging

1 Box 0,19 x 0,13 x 1,265 m  
 Vol 0,0312 m<sup>3</sup>  
 Gross weight 6,25 Kg Net weight 4,75 Kg

Notes

Surface fitting.  
 It includes interchangeable diffusers,  
 mink or orange finishes

**UNTIL STOCK RUNS OUT**



# Match

Design by Jordi Vilardell & Meritxell Vidal

Based on the principle of co-creation, Match is a lighting collection that can be fully customised virtually. Sculptural light structures arranged chaotically and adapted to fit into the room and the space available.

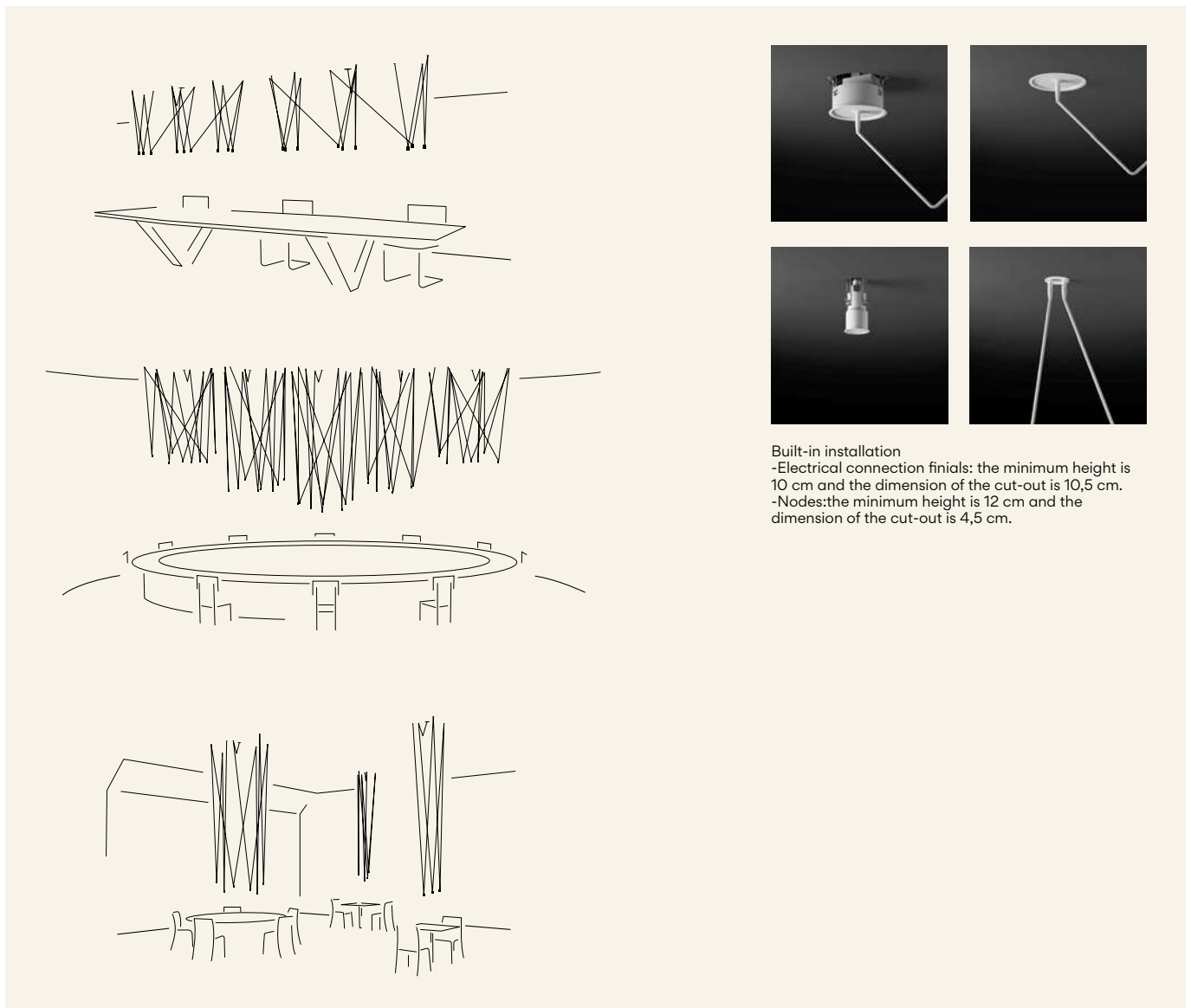

Built-in installation  
-Electrical connection finials: the minimum height is 10 cm and the dimension of the cut-out is 10,5 cm.  
-Nodes: the minimum height is 12 cm and the dimension of the cut-out is 4,5 cm.

Each project is unique. Visit [vibia.com](http://vibia.com) and chose among multiple compositions designed and adapted to your project needs.

Personalise your own Match composition quick and easy at [vibia.com](http://vibia.com)

**It's necessary to make your personalized configuration on [vibia.com](http://vibia.com) to see prices and place orders.**

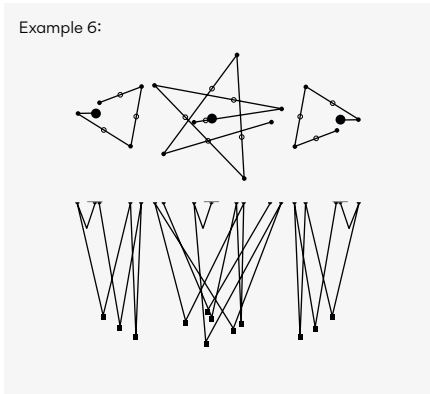
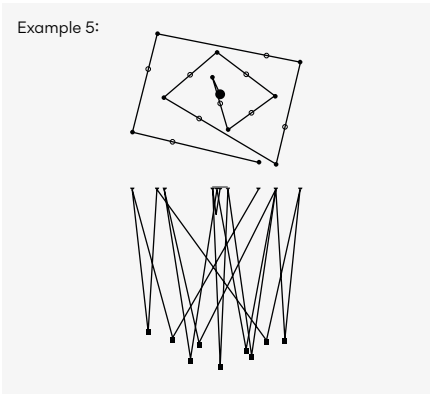
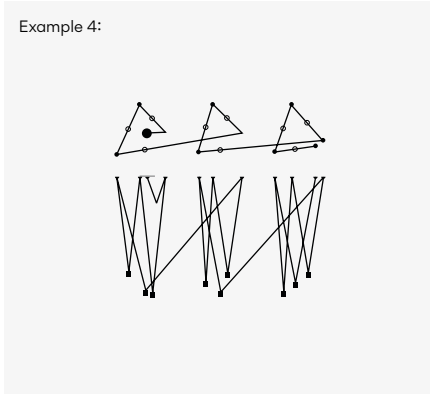
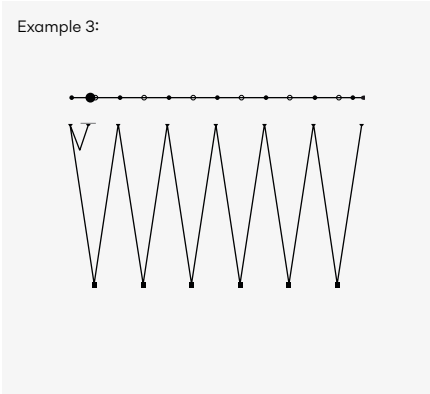
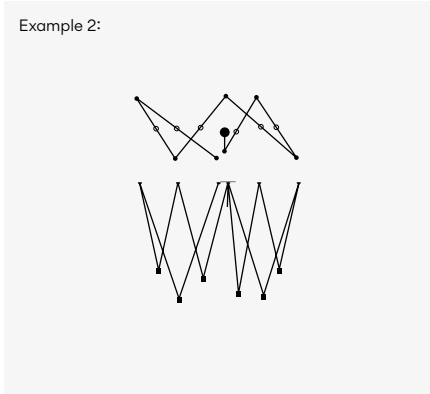
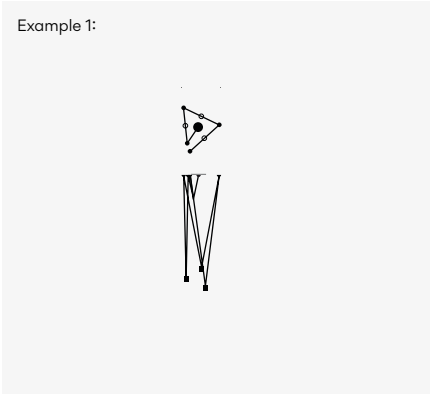

- Finishes**
- **03/ \_ \_ White**  
(RAL 9010)
  - **18/ \_ \_ Graphite**  
(RAL 7016)

**LED temperature colour**  
/1\_ 2700 K    
CRI >80 199 lm 95 lm/W

**Control**  
**A**  
DALI-2, 1-10V, Push  
**Z**  
Casambi

**Materials**  
Head: Aluminum. Canopy Plate: Steel.  
Rods: Steel.

**Light Source and electronics**  
LED 2,1 W 700 mA  
Constant Current 700 mA  
110-240V 50/60Hz

**Notes**  
Built-in  
**LED** **IP20** **CE** **EAC** **Bi-volt**   
⌀ 4,5 cm ⌀ 10,5 cm

**PLACE ORDER ONLINE AT [WWW.VIBIA.COM](http://WWW.VIBIA.COM)**





# Bulbs

| LED     |                                      |   | Fluorescent tube |                      |   |
|---------|--------------------------------------|---|------------------|----------------------|---|
| 900018. | LED G9 4,2W 2700K 470 lm.            |  9,75 €  | 900027.          | G5 230V 24W (T5)     |  5,25 €  |
| 900100. | LED G9 230V 3,8W LED 2700 K 470 lm   |  16,75 € | 900028.          | G5 230V 39W (T5)     |  10,25 € |
| 900102. | LED E27 230V 12W LED 2700 K 1520 lm  |  25,75 € | 900035.          | 2GX13 230V 55W (T5C) |  33,00 € |
| 900103. | LED E27 230V 9W 2700 K 800 lm        |  7,25 €  | 900070.          | 2GX13 230V 40W (T5C) |  26,50 € |
| 900105. | LED E27 PAR30 230V 10W 2700 K 630 lm |  28,50 € | 900071.          | 2GX13 230V 22W (T5C) |  26,50 € |
| 900106. | LED E14 230V 7W LED 2700 K 800 lm.   |  41,75 € | 900072.          | 2GX13 230V 60W (T5C) |  29,75 € |

**Bulbs: net prices, without discount**



# Professional area at vibia.com

## A new way of Working

We believe in cooperation and we bring you new ways to collaborate and online tools at [vibia.com](http://vibia.com) that we will help to work together efficiently. We propose a new way of working to have successful lighting projects.

Download all the information you need

Download and export all product information you need for your projects in one click:



Spec sheet

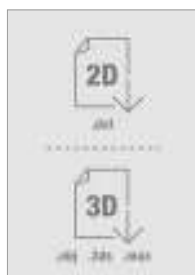

2D, 3D

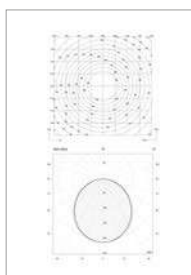

Photometry



HD images

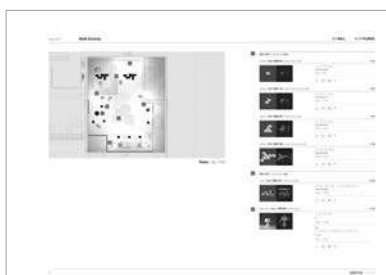

Project report



Budgets

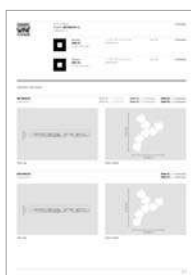

Product configuration spec sheet



Installation instructions

# Glossary

## CE

Product complying with the EN60598-1 and EN60598-2-1 European regulation.



Product complying with TP TC 004/2011 and TP TC 020/2011. Custom Union Regulation



Product that complies with the law N24-09 of the current Moroccan legislation.

## IP

Level of protection. Electrical products are prepared to avoid solids and liquids from getting in contact with the electrical parts. Such resistance is expressed as IP followed by two digits: the first digit indicates the level of resistance to solid objects and the second one to liquids. The scale goes from IP20 to IP68.



Product protected against solid object as big as or bigger than 12 mm. No protection against water.



Dust-tight product. Protected against water spray.



Dust-tight product. Protected against water trickles.



Dust-tight product. Protected against water spurts.

## Insulation class



Class I. Product with an additional protection cable (grounds).



Class II. Product protected against electric shock having a double insulation. No grounds.



Class III. Product protected against electric shock based on a very-low voltage system. No grounds.

## Flammable surfaces



Product suitable to be installed on any kind of surface (EN 60598).



Product that **CANNOT** be in contact with normally-flammable materials (wood or others).



Valid for the range 110V-230V, 50-60Hz.



Valid for the range 110-277V, 50-60Hz.



Contains lithium-ion battery. Li-Ion battery must be disposed of into label containers, returned to special waste collection points or retailers of electrical equipment.

## Cut out



Property for embedding dimension.

## No electronic equipment included



The lamp does not include any electronic equipment (transformer, driver, ballast...).

## Integrated Dimmer



Lamp that has a integrated dimmer.

## EU Energetic label

More Efficacy



Less Efficacy

## Light source information

CRI  
Colour rendering index.

K  
Colour temperature.

lm  
Lumen, unit of measurement of luminous flux.

lm/W  
Light source performance. Relationship between the luminous flux (lm) and the power consumed (W) by the source.



LED included.

# Lighting control systems

1 Push control

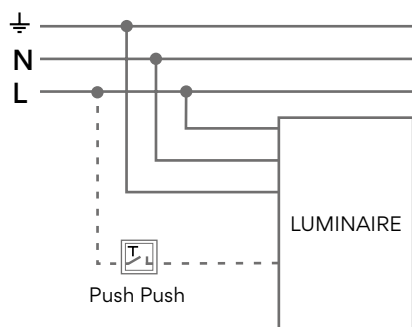

2 1-10V System control

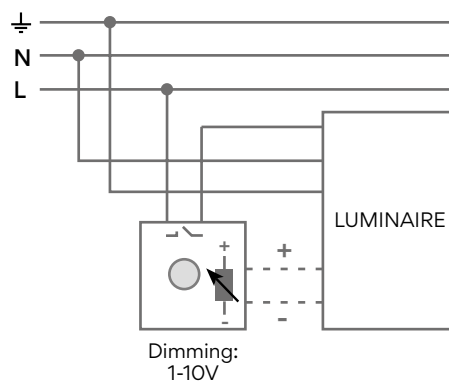

3 DALI System control

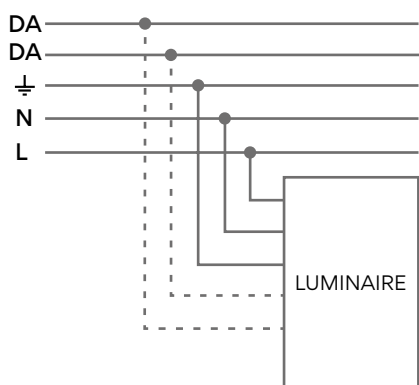

4 Casambi control

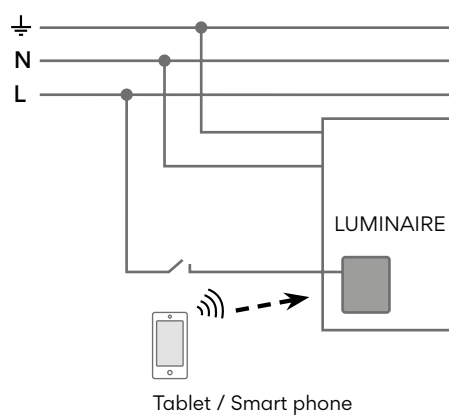

5 TRIAC control

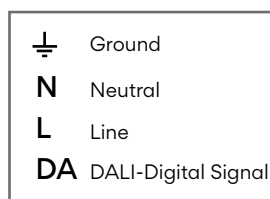
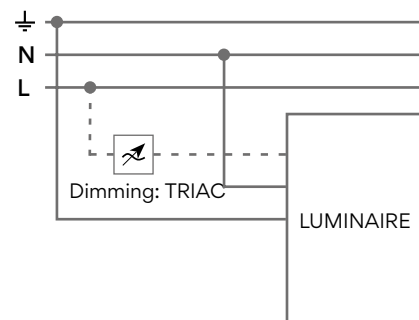

**Very important**

Vibia Lighting S.L.U. has the right to change any model or finish of the products included in the picture catalogue without any previous notice.

Vibia Lighting, S.L.U.

**Office**

Progrés 4-6.

08850 Gavà (Barcelona).

International Tel +34 934 796 971.

[customer.service@vibia.com](mailto:customer.service@vibia.com)

[vibia.com](http://vibia.com)

COPYRIGHT© VIBIA LIGHTING S.L.U. ALL RIGHTS RESERVED.



