

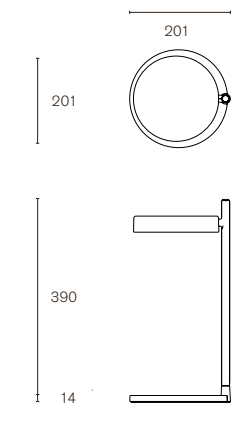
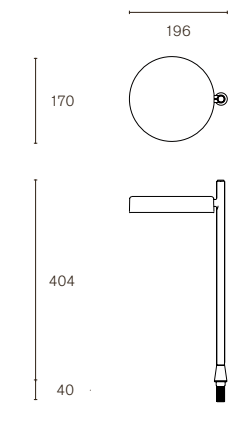
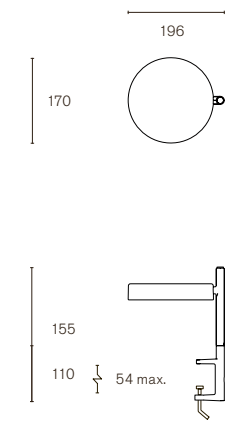
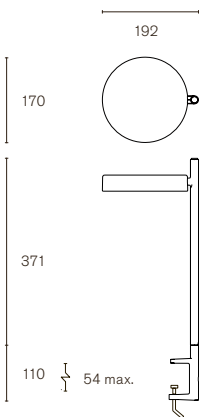
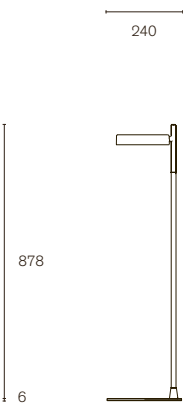

**Public price list
EUR**

January 2020

w 182 pastille	3–5
w 181 linier	6
w 171 alma	7
w 164 alto	8
w 163 lampyre	9
w 162 dalston	10–11
w 154 pal	12
w 153 île	13
w 152 busby	14–15
w 151 extra large pendant	16
w 132 nendo	17–21
w 131 bell	22
w 127 winkel	23–25
w 126 claesson koivisto rune	26
w 124 lindvall	27–28
w 103 sempé	29–30
w 102 chipperfield	31–32
w 084 studioilse	33

Product name	w 182 pastille b2	w 182 pastille p2	w 182 pastille c1						
Dimensions (mm)									
Model	Table lamp – long arm	Table lamp – long arm	Table lamp – short arm						
Mounting	Base	Pin – integrated (cut-out Ø 20 mm)	Clamp						
Material	Solid fiberglass reinforced biopolyamide	Solid fiberglass reinforced biopolyamide	Solid fiberglass reinforced biopolyamide						
Cord length	200 cm	200 cm	200 cm						
Light source	LED COB	LED COB	LED COB						
Watt	6 W	6 W	6 W						
Lumen	690	690	690						
Lumen/W	115	115	115						
Colour temperature	2700 K	2700 K	2700 K						
CRI	>90	>90	>90						
Light source life expectancy	50.000 h	50.000 h	50.000 h						
Light control	Dimmable	Dimmable	Dimmable						
Energy class	A++	A++	A++						
IP-classification	20	20	20						
Packaging dimensions	L51.7 x W22.5 x H6.4 cm (0.007m3)	L51.7 x W22.5 x H6.4 cm (0.007m3)	L51.7 x W22.5 x H6.4 cm (0.007m3)						
Packaging weight	2.4 kg	2.2 kg	2.3 kg						
	Colour	Art. no. / EAN code	Price ex. VAT	Colour	Art. no. / EAN code	Price ex. VAT	Colour	Art. no. / EAN code	Price ex. VAT
	Oxide red	182B23009 / 7330492008080	222 EUR	Oxide red	182P23009 / 7330492008363	201 EUR	Oxide red	182C13009 / 7330492008202	218 EUR
	Olive green	182B26003 / 7330492008097	222 EUR	Olive green	182P26003 / 7330492008370	201 EUR	Olive green	182C16003 / 7330492008219	218 EUR
	Soft white	182B20250 / 7330492008103	222 EUR	Soft white	182P20250 / 7330492008387	201 EUR	Soft white	182C10250 / 7330492008226	218 EUR
	Graphite black	182B29011 / 7330492008110	222 EUR	Graphite black	182P29011 / 7330492008394	201 EUR	Graphite black	182C19011 / 7330492008233	218 EUR

Product name	w 182 pastille c2	w 182 pastille f1	w 182 pastille f2						
Dimensions (mm)									
Model	Table lamp – long arm	Floor lamp – short arm	Floor lamp – long arm						
Mounting	Clamp	Free-standing	Free-standing						
Material	Solid fiberglass reinforced biopolyamide	Solid fiberglass reinforced biopolyamide, steel	Solid fiberglass reinforced biopolyamide, steel						
Cord length	200 cm	300 cm	300 cm						
Light source	LED COB	LED COB	LED COB						
Watt	6 W	6 W	6 W						
Lumen	690	690	690						
Lumen/W	115	115	115						
Colour temperature	2700 K	2700 K	2700 K						
CRI	>90	>90	>90						
Light source life expectancy	50.000 h	50.000 h	50.000 h						
Light control	Dimmable	Dimmable	Dimmable						
Energy class	A++	A++	A++						
IP-classification	20	20	20						
Packaging dimensions	L51.7 x W22.5 x H6.4 cm (0.007m3)	L75.0 x W32.5 x H5.0 cm (0.01m3)	L75.0 x W32.5 x H5.0 cm (0.01m3)						
Packaging weight	2.3 kg	3.8 kg	3.8 kg						
	Colour	Art. no. / EAN code	Price ex. VAT	Colour	Art. no. / EAN code	Price ex. VAT	Colour	Art. no. / EAN code	Price ex. VAT
	Oxide red	182C23009 / 7330492008240	218 EUR	Oxide red	182F13009 / 7330492008288	351 EUR	Oxide red	182F23009 / 7330492008325	351 EUR
	Olive green	182C26003 / 7330492008257	218 EUR	Olive green	182F16003 / 7330492008295	351 EUR	Olive green	182F26003 / 7330492008332	351 EUR
	Soft white	182C20250 / 7330492008264	218 EUR	Soft white	182F10250 / 7330492008301	351 EUR	Soft white	182F20250 / 7330492008349	351 EUR
	Graphite black	182C29011 / 7330492008271	218 EUR	Graphite black	182F19011 / 7330492008318	351 EUR	Graphite black	182F29011 / 7330492008356	351 EUR

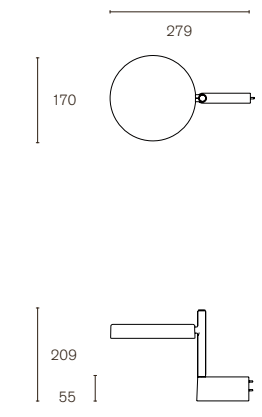
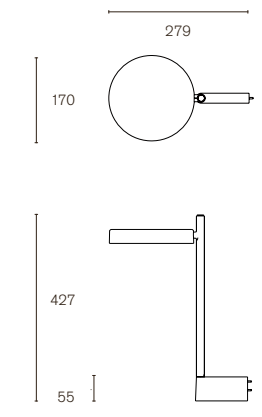
Product name	w 182 pastille br1	w 182 pastille br2				
Dimensions (mm)						
Model	Wall lamp – short arm	Wall lamp – long arm				
Mounting	Wall bracket	Wall bracket				
Material	Solid fiberglass reinforced biopolyamide					
Cord length	200 cm					
Light source	LED COB					
Watt	6 W					
Lumen	690					
Lumen/W	115					
Colour temperature	2700 K					
CRI	>90					
Light source life expectancy	50.000 h					
Light control	Dimmable					
Energy class	A++					
IP-classification	20					
Packaging dimensions	L51.7 x W22.5 x H6.4 cm (0.007m3)					
Packaging weight	2.3 kg					
	Colour	Art. no. / EAN code	Price ex. VAT	Colour	Art. no. / EAN code	Price ex. VAT
	Oxide red	182BR13009 / 7330492008127	207 EUR	Oxide red	182BR23009 / 7330492008165	207 EUR
	Olive green	182BR16003 / 7330492008134	207 EUR	Olive green	182BR26003 / 7330492008172	207 EUR
	Soft white	182BR10250 / 7330492008141	207 EUR	Soft white	182BR20250 / 7330492008189	207 EUR
	Graphite black	182BR19011 / 7330492008158	207 EUR	Graphite black	182BR29011 / 7330492008196	207 EUR

Product name	w 181 linier s		
Dimensions (mm)			
Model	Pedant Lamp		
Mounting	Ceiling rose – included		
Material	Aluminium		
Cord length	300 cm		
Light source	Integrated LED – included		
Watt	49 W		
Lumen	7100		
Lumen/W	145		
Colour temperature	3000 K		
CRI	>90		
Light source life expectancy	50.000 h		
Light control	Dimmable / Push dim / DALI		
Energy class	A++		
IP-classification	20		
Packaging dimensions	WIP		
Packaging weight	WIP		
	Colour / Light control	Art. no. / EAN code	Price ex. VAT
	Anodized black / Dimmable	181S1105 / 330492008516	725 EUR
	Anodized black / Push dim	181S1205 / 330492008523	725 EUR
	Anodized black / DALI	181S1305 / 330492008530	725 EUR

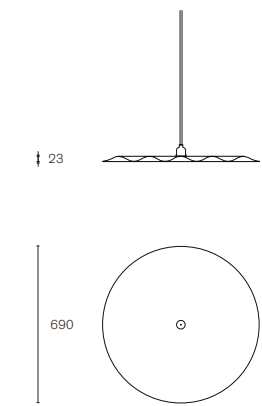
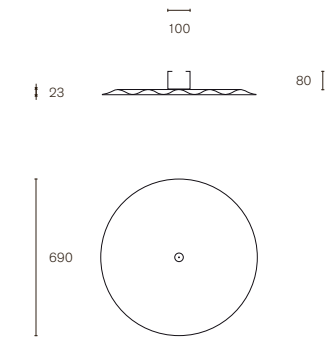
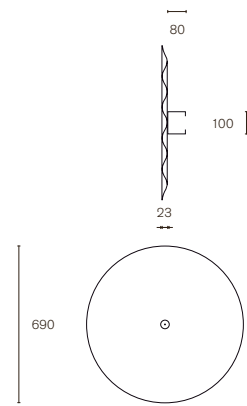
Product name	w171 alma s	w171 alma c/w	w171 alma w						
Dimensions (mm)									
Model	Pendant lamp	Ceiling lamp/Wall lamp	Wall lamp						
Mounting	Ceiling rose – included	Mounting plate – included	Mounting plate – included						
Material	Aluminium	Aluminium	Aluminium						
Cord length	300 cm	N/A	300 cm						
Light source	1 x E27 socket – light source included (not for US)	1 x E27 socket – light source included (not for US)	1 x E27 socket – light source included (not for US)						
Watt	Max 40 W	Max 40 W	Max 40 W						
Lumen	N/A	N/A	N/A						
Lumen/W	N/A	N/A	N/A						
Colour temperature	N/A	N/A	N/A						
CRI	N/A	N/A	N/A						
Light source life expectancy	N/A	N/A	N/A						
Light control	Dimmable	Dimmable	Dimmable						
Energy class	N/A	N/A	N/A						
IP-classification	20	20	20						
Packaging dimensions	L80 x W78 x H15 cm (0.09 m³)	L80 x W78 x H15 cm (0.09 m³)	L80 x W78 x H15 cm (0.09 m³)						
Packaging weight	4 kg	4.5 kg	4.5 kg						
	Colour	Art. no. / EAN code	Price ex. VAT	Colour	Art. no. / EAN code	Price ex. VAT	Colour	Art. no. / EAN code	Price ex. VAT
	Signal white	171S19003 / 7330492007953	330 EUR	Signal white	171C/W19003 / 7330492007939	365 EUR	Signal white	171W19003 / 7330492007977	378 EUR
	Grey white	171S19002 / 7330492007946	330 EUR	Grey white	171C/W19002 / 7330492007922	365 EUR	Grey white	171W19002 / 7330492007960	378 EUR

Product name	w164 alto		
Dimensions (mm)			
Model	Floor lamp		
Mounting	Free-standing		
Material	Aluminium and steel		
Cord length	300 cm		
Light source	Integrated LED – included		
Watt	55		
Lumen	7000		
Lumen/W	127		
Colour temperature	2700–2850 K by dynamic dimming		
CRI	90		
Light source life expectancy	50.000 h		
Light control	Dynamic dimming		
Energy class	A++		
IP-classification	20		
Packaging dimensions	L195 x W22 x H27 cm (0.03 m³)		
Packaging weight	23 kg		
	Colour	Art. no. / EAN code	Price ex. VAT
	White	164F102 / 7330492007588	1654 EUR
	Grey	164F104 / 7330492007595	1654 EUR
	Black	164F105 / 7330492007601	1654 EUR

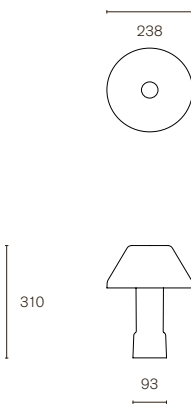
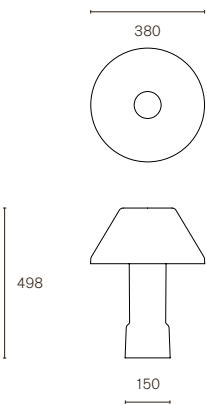
Product name	w163 lampyre t1			w163 lampyre t2		
Dimensions (mm)						
Model	Table lamp – small			Table lamp – large		
Mounting	Base			Base		
Material	Opaline glass			Opaline glass		
Cord length	250 cm			250 cm		
Light source	1 x E14 socket – light source not included			1 x E27 socket – light source not included		
Watt	Max 40 W			Max 40 W		
Lumen	N/A			N/A		
Colour temperature	N/A			N/A		
CRI	N/A			N/A		
Light source life expectancy	N/A			N/A		
Light control	Dimmable			Dimmable		
Energy class	N/A			N/A		
IP-classification	20			20		
Packaging dimensions	L44 x W38 x H16 cm (0.03 m ³)			L63 x W58 x H24 cm (0.09 m ³)		
Packaging weight	2.5 kg			4.5 kg		
	Colour	Art. no. / EAN code	Price ex. VAT	Colour	Art. no. / EAN code	Price ex. VAT
	White opaline	163T100 / 7330492007564	378 EUR	White opaline	163T200 / 7330492007571	602 EUR

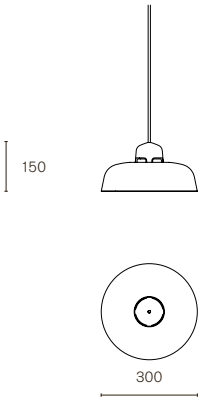
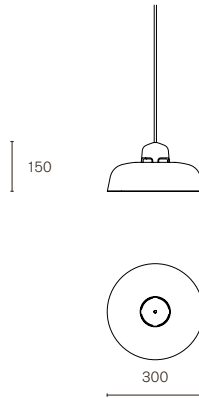
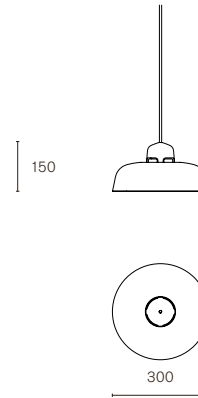
Product name	w162 dalston s1	w162 dalston s1	w162 dalston s1						
Dimensions (mm)									
Model	Pendant lamp – small shade	Pendant lamp – small shade	Pendant lamp – small shade						
LED unit	Black	Silver	Gold						
Mounting	Ceiling rose – included	Ceiling rose – included	Ceiling rose – included						
Material	Steel, aluminium	Steel, aluminium	Steel, aluminium						
Cord length	300 cm, textile cable	300 cm, textile cable	300 cm, textile cabl						
Light source	Integrated LED – included	Integrated LED – included	Integrated LED – included						
Watt	9 W	9 W	9 W						
Lumen	1100	1100	1100						
Lumen/W	122	122	122						
Colour temperature	2700 K	2700 K	2700 K						
CRI	> 80	> 80	> 80						
Light source life expectancy	50.000 h	50.000 h	50.000 h						
Light control	Dimmable	Dimmable	Dimmable						
Energy class	A++	A++	A++						
IP-classification	20	20	20						
Packaging dimensions	L52 x W40 x H18 cm (0.04 m ³)	L52 x W40 x H18 cm (0.04 m ³)	L52 x W40 x H18 cm (0.04 m ³)						
Packaging weight	2.5 kg	2.5 kg	2.5 kg						
	Colour	Art. no. / EAN code	Price ex. VAT	Colour	Art. no. / EAN code	Price ex. VAT	Colour	Art. no. / EAN code	Price ex. VAT
	Signal white shade Black LED-unit	162S119003 / 7330492007083	342 EUR	Signal white shade Silver LED-unit	162S129003 / 7330492007090	342 EUR	Signal white shade Gold LED-unit	162S139003 / 7330492007106	342 EUR
	Graphite black shade Black LED-unit	162S119011 / 7330492007113	342 EUR	Graphite black shade Silver LED-unit	162S129011 / 7330492007120	342 EUR	Graphite black shade Gold LED-unit	162S139011 / 7330492007137	342 EUR
	Silk grey shade Black LED-unit	162S117044 / 7330492007144	342 EUR	Silk grey shade Silver LED-unit	162S127044 / 7330492007151	342 EUR	Silk grey shade Gold LED-unit	162S137044 / 7330492007168	342 EUR
	Red orange shade Black LED-unit	162S112001 / 7330492007175	342 EUR	Red orange shade Silver LED-unit	162S122001 / 7330492007182	342 EUR	Red orange shade Gold LED-unit	162S132001 / 7330492007199	342 EUR
	Nut brown shade Black LED-unit	162S118011 / 7330492007205	342 EUR	Nut brown shade Silver LED-unit	162S128011 / 7330492007212	342 EUR	Nut brown shade Gold LED-unit	162S138011 / 7330492007229	342 EUR
	Olive yellow shade Black LED-unit	162S111020 / 7330492007236	342 EUR	Olive yellow shade Silver LED-unit	162S121020 / 7330492007243	342 EUR	Olive yellow shade Gold LED-unit	162S131020 / 7330492007250	342 EUR
	Moss green shade Black LED-unit	162S116005 / 7330492007267	342 EUR	Moss green shade Silver LED-unit	162S126005 / 7330492007274	342 EUR	Moss green shade Gold LED-unit	162S136005 / 7330492007281	342 EUR
	Steel blue shade Black LED-unit	162S115011 / 7330492007816	342 EUR	Steel blue shade Silver LED-unit	162S125011 / 7330492007823	342 EUR	Steel blue shade Gold LED-unit	162S135011 / 7330492007830	342 EUR

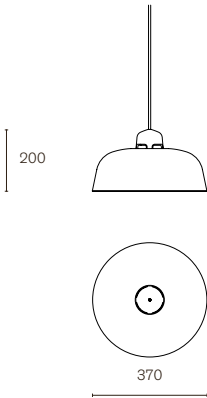
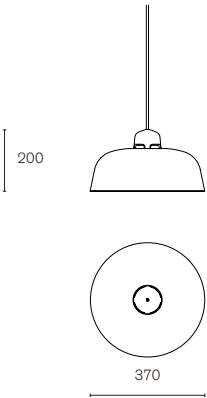
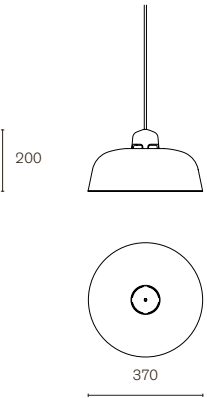
Product name	w162 dalston s2	w162 dalston s2	w162 dalston s2																																																																																	
Dimensions (mm)																																																																																				
Model	Pendant lamp – large shade	Pendant lamp – large shade	Pendant lamp – large shade																																																																																	
LED unit	Black	Silver	Gold																																																																																	
Mounting	Ceiling rose – included	Ceiling rose – included	Ceiling rose – included																																																																																	
Material	Steel, aluminium	Steel, aluminium	Steel, aluminium																																																																																	
Cord length	300 cm, textile cable	300 cm, textile cable	300 cm, textile cable																																																																																	
Light source	Integrated LED – included	Integrated LED – included	Integrated LED – included																																																																																	
Watt	9 W	9 W	9 W																																																																																	
Lumen	1100	1100	1100																																																																																	
Lumen/W	122	122	122																																																																																	
Colour temperature	2700 K	2700 K	2700 K																																																																																	
CRI	> 80	> 80	> 80																																																																																	
Light source life expectancy	50.000 h	50.000 h	50.000 h																																																																																	
Light control	Dimmable	Dimmable	Dimmable																																																																																	
Energy class	A++	A++	A++																																																																																	
IP-classification	20	20	20																																																																																	
Packaging dimensions	L52 x W40 x H18 cm (0.04 m ³)	L52 x W40 x H18 cm (0.04 m ³)	L52 x W40 x H18 cm (0.04 m ³)																																																																																	
Packaging weight	2.5 kg	2.5 kg	2.5 kg																																																																																	
	<table border="1"> <thead> <tr> <th>Colour</th> <th>Art. no. / EAN code</th> <th>Price ex. VAT</th> </tr> </thead> <tbody> <tr> <td>Signal white shade Black LED-unit</td> <td>162S219003 / 7330492007298</td> <td>414 EUR</td> </tr> <tr> <td>Graphite black shade Black LED-unit</td> <td>162S219011 / 7330492007328</td> <td>414 EUR</td> </tr> <tr> <td>Silk grey shade Black LED-unit</td> <td>162S217044 / 7330492007359</td> <td>414 EUR</td> </tr> <tr> <td>Red orange shade Black LED-unit</td> <td>162S212001 / 7330492007380</td> <td>414 EUR</td> </tr> <tr> <td>Nut brown shade Black LED-unit</td> <td>162S218011 / 7330492007410</td> <td>414 EUR</td> </tr> <tr> <td>Olive yellow shade Black LED-unit</td> <td>162S211020 / 7330492007441</td> <td>414 EUR</td> </tr> <tr> <td>Moss green shade Black LED-unit</td> <td>162S216005 / 7330492007472</td> <td>414 EUR</td> </tr> <tr> <td>Steel blue shade Black LED-unit</td> <td>162S215011 / 7330492007847</td> <td>414 EUR</td> </tr> </tbody> </table>	Colour	Art. no. / EAN code	Price ex. VAT	Signal white shade Black LED-unit	162S219003 / 7330492007298	414 EUR	Graphite black shade Black LED-unit	162S219011 / 7330492007328	414 EUR	Silk grey shade Black LED-unit	162S217044 / 7330492007359	414 EUR	Red orange shade Black LED-unit	162S212001 / 7330492007380	414 EUR	Nut brown shade Black LED-unit	162S218011 / 7330492007410	414 EUR	Olive yellow shade Black LED-unit	162S211020 / 7330492007441	414 EUR	Moss green shade Black LED-unit	162S216005 / 7330492007472	414 EUR	Steel blue shade Black LED-unit	162S215011 / 7330492007847	414 EUR	<table border="1"> <thead> <tr> <th>Colour</th> <th>Art. no. / EAN code</th> <th>Price ex. VAT</th> </tr> </thead> <tbody> <tr> <td>Signal white shade Silver LED-unit</td> <td>162S229003 / 7330492007304</td> <td>414 EUR</td> </tr> <tr> <td>Graphite black shade Silver LED-unit</td> <td>162S229011 / 7330492007335</td> <td>414 EUR</td> </tr> <tr> <td>Silk grey shade Silver LED-unit</td> <td>162S227044 / 7330492007366</td> <td>414 EUR</td> </tr> <tr> <td>Red orange shade Silver LED-unit</td> <td>162S222001 / 7330492007397</td> <td>414 EUR</td> </tr> <tr> <td>Nut brown shade Silver LED-unit</td> <td>162S228011 / 7330492007427</td> <td>414 EUR</td> </tr> <tr> <td>Olive yellow shade Silver LED-unit</td> <td>162S221020 / 7330492007458</td> <td>414 EUR</td> </tr> <tr> <td>Moss green shade Silver LED-unit</td> <td>162S226005 / 7330492007489</td> <td>414 EUR</td> </tr> <tr> <td>Steel blue shade Silver LED-unit</td> <td>162S225011 / 7330492007854</td> <td>414 EUR</td> </tr> </tbody> </table>	Colour	Art. no. / EAN code	Price ex. VAT	Signal white shade Silver LED-unit	162S229003 / 7330492007304	414 EUR	Graphite black shade Silver LED-unit	162S229011 / 7330492007335	414 EUR	Silk grey shade Silver LED-unit	162S227044 / 7330492007366	414 EUR	Red orange shade Silver LED-unit	162S222001 / 7330492007397	414 EUR	Nut brown shade Silver LED-unit	162S228011 / 7330492007427	414 EUR	Olive yellow shade Silver LED-unit	162S221020 / 7330492007458	414 EUR	Moss green shade Silver LED-unit	162S226005 / 7330492007489	414 EUR	Steel blue shade Silver LED-unit	162S225011 / 7330492007854	414 EUR	<table border="1"> <thead> <tr> <th>Colour</th> <th>Art. no. / EAN code</th> <th>Price ex. VAT</th> </tr> </thead> <tbody> <tr> <td>Signal white shade Gold LED-unit</td> <td>162S239003 / 7330492007311</td> <td>414 EUR</td> </tr> <tr> <td>Graphite black shade Gold LED-unit</td> <td>162S239011 / 7330492007342</td> <td>414 EUR</td> </tr> <tr> <td>Silk grey shade Gold LED-unit</td> <td>162S237044 / 7330492007373</td> <td>414 EUR</td> </tr> <tr> <td>Red orange shade Gold LED-unit</td> <td>162S232001 / 7330492007403</td> <td>414 EUR</td> </tr> <tr> <td>Nut brown shade Gold LED-unit</td> <td>162S238011 / 7330492007434</td> <td>414 EUR</td> </tr> <tr> <td>Olive yellow shade Gold LED-unit</td> <td>162S231020 / 7330492007465</td> <td>414 EUR</td> </tr> <tr> <td>Moss green shade Gold LED-unit</td> <td>162S236005 / 7330492007496</td> <td>414 EUR</td> </tr> <tr> <td>Steel blue shade Gold LED-unit</td> <td>162S235011 / 7330492007861</td> <td>414 EUR</td> </tr> </tbody> </table>	Colour	Art. no. / EAN code	Price ex. VAT	Signal white shade Gold LED-unit	162S239003 / 7330492007311	414 EUR	Graphite black shade Gold LED-unit	162S239011 / 7330492007342	414 EUR	Silk grey shade Gold LED-unit	162S237044 / 7330492007373	414 EUR	Red orange shade Gold LED-unit	162S232001 / 7330492007403	414 EUR	Nut brown shade Gold LED-unit	162S238011 / 7330492007434	414 EUR	Olive yellow shade Gold LED-unit	162S231020 / 7330492007465	414 EUR	Moss green shade Gold LED-unit	162S236005 / 7330492007496	414 EUR	Steel blue shade Gold LED-unit	162S235011 / 7330492007861	414 EUR
Colour	Art. no. / EAN code	Price ex. VAT																																																																																		
Signal white shade Black LED-unit	162S219003 / 7330492007298	414 EUR																																																																																		
Graphite black shade Black LED-unit	162S219011 / 7330492007328	414 EUR																																																																																		
Silk grey shade Black LED-unit	162S217044 / 7330492007359	414 EUR																																																																																		
Red orange shade Black LED-unit	162S212001 / 7330492007380	414 EUR																																																																																		
Nut brown shade Black LED-unit	162S218011 / 7330492007410	414 EUR																																																																																		
Olive yellow shade Black LED-unit	162S211020 / 7330492007441	414 EUR																																																																																		
Moss green shade Black LED-unit	162S216005 / 7330492007472	414 EUR																																																																																		
Steel blue shade Black LED-unit	162S215011 / 7330492007847	414 EUR																																																																																		
Colour	Art. no. / EAN code	Price ex. VAT																																																																																		
Signal white shade Silver LED-unit	162S229003 / 7330492007304	414 EUR																																																																																		
Graphite black shade Silver LED-unit	162S229011 / 7330492007335	414 EUR																																																																																		
Silk grey shade Silver LED-unit	162S227044 / 7330492007366	414 EUR																																																																																		
Red orange shade Silver LED-unit	162S222001 / 7330492007397	414 EUR																																																																																		
Nut brown shade Silver LED-unit	162S228011 / 7330492007427	414 EUR																																																																																		
Olive yellow shade Silver LED-unit	162S221020 / 7330492007458	414 EUR																																																																																		
Moss green shade Silver LED-unit	162S226005 / 7330492007489	414 EUR																																																																																		
Steel blue shade Silver LED-unit	162S225011 / 7330492007854	414 EUR																																																																																		
Colour	Art. no. / EAN code	Price ex. VAT																																																																																		
Signal white shade Gold LED-unit	162S239003 / 7330492007311	414 EUR																																																																																		
Graphite black shade Gold LED-unit	162S239011 / 7330492007342	414 EUR																																																																																		
Silk grey shade Gold LED-unit	162S237044 / 7330492007373	414 EUR																																																																																		
Red orange shade Gold LED-unit	162S232001 / 7330492007403	414 EUR																																																																																		
Nut brown shade Gold LED-unit	162S238011 / 7330492007434	414 EUR																																																																																		
Olive yellow shade Gold LED-unit	162S231020 / 7330492007465	414 EUR																																																																																		
Moss green shade Gold LED-unit	162S236005 / 7330492007496	414 EUR																																																																																		
Steel blue shade Gold LED-unit	162S235011 / 7330492007861	414 EUR																																																																																		

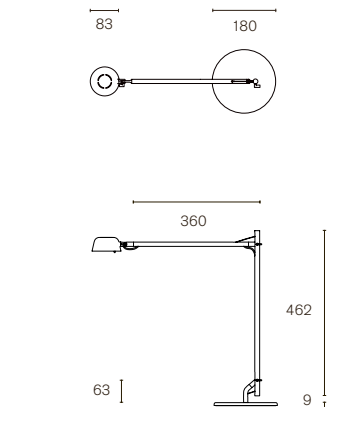
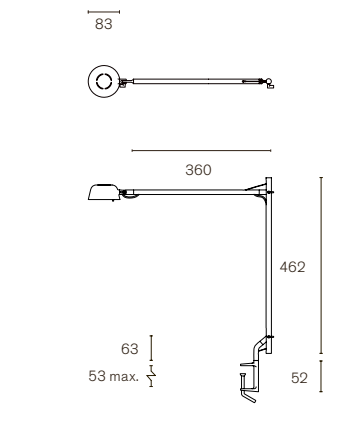
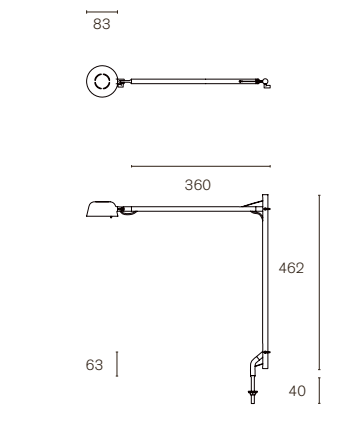
Product name	w154 pal b	w154 pal c	w154 pal p																											
Dimensions (mm)																														
Model	Table lamp	Table lamp	Table lamp																											
Mounting	Base	Clamp	Pin – integrated (cut-out Ø 8 mm)																											
Material	Aluminium	Aluminium	Aluminium																											
Cord length	215 cm	215 cm	215 cm																											
Light source	Integrated LED – included	Integrated LED – included	Integrated LED – included																											
Watt	8 W	8 W	8 W																											
Lumen	900	900	900																											
Lumen/W	112	112	112																											
Color temperature	3000 K	3000 K	3000 K																											
CRI	> 90	> 90	> 90																											
Light source life expectancy	50.000 h	50.000 h	50.000 h																											
Light control	2-step switch	2-step switch	2-step switch																											
Energy class	A++	A++	A++																											
IP-classification	20	20	20																											
Packaging dimensions	L79.5 x W34 x H6.5 cm (0.02 m³)	L79.5 x W34 x H6.5 cm (0.02 m³)	L79.5 x W34 x H6.5 cm (0.02 m³)																											
Packaging weight	3.4 kg	1.4 kg	1.4 kg																											
	<table border="1"> <thead> <tr> <th>Colour</th> <th>Art. no. / EAN code</th> <th>Price ex. VAT</th> </tr> </thead> <tbody> <tr> <td>Black</td> <td>154B205.2 / 7330492006437</td> <td>237 EUR</td> </tr> <tr> <td>White</td> <td>154B202.2 / 7330492006444</td> <td>237 EUR</td> </tr> </tbody> </table>	Colour	Art. no. / EAN code	Price ex. VAT	Black	154B205.2 / 7330492006437	237 EUR	White	154B202.2 / 7330492006444	237 EUR	<table border="1"> <thead> <tr> <th>Colour</th> <th>Art. no. / EAN code</th> <th>Price ex. VAT</th> </tr> </thead> <tbody> <tr> <td>Black</td> <td>154C205.2 / 7330492006451</td> <td>211 EUR</td> </tr> <tr> <td>White</td> <td>154C202.2 / 7330492006468</td> <td>211 EUR</td> </tr> </tbody> </table>	Colour	Art. no. / EAN code	Price ex. VAT	Black	154C205.2 / 7330492006451	211 EUR	White	154C202.2 / 7330492006468	211 EUR	<table border="1"> <thead> <tr> <th>Colour</th> <th>Art. no. / EAN code</th> <th>Price ex. VAT</th> </tr> </thead> <tbody> <tr> <td>Black</td> <td>154P205.2 / 7330492006475</td> <td>211 EUR</td> </tr> <tr> <td>White</td> <td>154P202.2 / 7330492006482</td> <td>211 EUR</td> </tr> </tbody> </table>	Colour	Art. no. / EAN code	Price ex. VAT	Black	154P205.2 / 7330492006475	211 EUR	White	154P202.2 / 7330492006482	211 EUR
Colour	Art. no. / EAN code	Price ex. VAT																												
Black	154B205.2 / 7330492006437	237 EUR																												
White	154B202.2 / 7330492006444	237 EUR																												
Colour	Art. no. / EAN code	Price ex. VAT																												
Black	154C205.2 / 7330492006451	211 EUR																												
White	154C202.2 / 7330492006468	211 EUR																												
Colour	Art. no. / EAN code	Price ex. VAT																												
Black	154P205.2 / 7330492006475	211 EUR																												
White	154P202.2 / 7330492006482	211 EUR																												

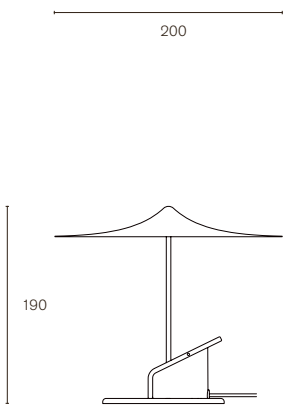
Product name	w153 île		
Dimensions (mm)			
Model	Multipurpose lamp		
Mounting	Base, clamp and wall-mounted		
Material	Aluminium		
Cord length	200 cm		
Light source	Integrated LED – included		
Watt	6 W		
Lumen	690		
Lumen/W	115		
Colour temperature	2700 K		
CRI	> 90		
Light source life expectancy	50.000 h		
Light control	On/off		
Energy class	A++		
IP-classification	20		
Packaging dimensions	L21 x W21 x H11 cm (0.005 m³)		
Packaging weight	0.8 kg		
	Colour	Art. no. / EAN code	Price ex. VAT
	Poppy red	153M10580 / 7330492006062	188 EUR
	Sky blue	153M10515 / 7330492006079	188 EUR
	Light yellow	153M11020 / 7330492006086	188 EUR
	Grey brown	153M15010 / 7330492006093	188 EUR
	Petrol	153M16530 / 7330492006109	188 EUR
	Traffic white	153M19016 / 7330492007991	188 EUR
	Jet black	153M19005 / 7330492007984	188 EUR

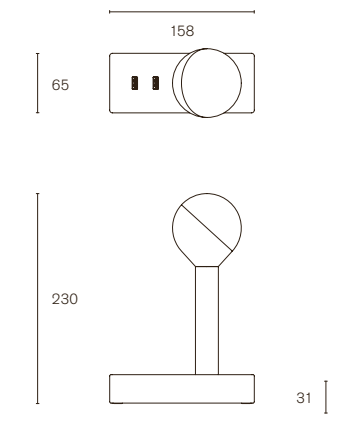
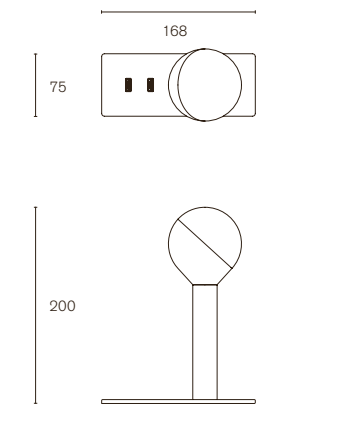
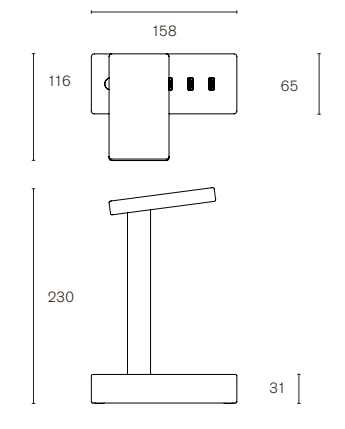
Product name	w152 busby b1	w152 busby i1	w152 busby b2						
Dimensions (mm)									
Model	Ambient lamp	Ambient lamp	Directable lamp						
USB sockets	3 x 3 amps, 5V	3 x 3 amps, 5V	3 x 3 amps, 5V						
Mounting	Base, free-standing and wall-mounted	Integrated (cut-out 160 x 67 mm)	Base, free-standing and wall-mounted						
Material	Aluminium	Aluminium	Aluminium						
Cord length	160 cm	160 cm	160 cm						
Light source	Integrated LED – included	Integrated LED – included	Integrated LED – included						
Watt	6 W	6 W	6 W						
Lumen	690	690	690						
Lumen/W	115	115	115						
Colour temperature	2700 K	2700 K	2700 K						
CRI	> 90	> 90	> 90						
Light source life expectancy	50.000 h	50.000 h	50.000 h						
Light control	Dimmable	Dimmable	Dimmable						
Energy class	A++	A++	A++						
IP-classification	20	20	20						
Packaging dimensions	L27 x W23.5 x H9 cm (0.01 m ³)	L27 x W23.5 x H9 cm (0.01 m ³)	L27 x W23.5 x H9 cm (0.01 m ³)						
Packaging weight	1 kg	1 kg	1.2 kg						
	Colour	Art. no. / EAN code	Price ex. VAT	Colour	Art. no. / EAN code	Price ex. VAT	Colour	Art. no. / EAN code	Price ex. VAT
	Black	152B105 / 7330492005621	414 EUR	Black	152I105 / 7330492005645	443 EUR	Black	152B205 / 7330492005669	422 EUR
	Silver	152B104 / 7330492005638	414 EUR	Silver	152I104 / 7330492005652	443 EUR	Silver	152B204 / 7330492005676	422 EUR

Product name	w152 Busby i2		
Dimensions (mm)			
Model	Directable lamp		
USB sockets	3 x 3 amps, 5V		
Mounting	Integrated (cut-out 160 x 67 mm)		
Material	Aluminium		
Cord length	160 cm		
Light source	Integrated LED – included		
Watt	6 W		
Lumen	690		
Lumen/W	115		
Colour temperature	2700 K		
CRI	> 90		
Light source life expectancy	50.000 h		
Light control	Dimmable		
Energy class	A++		
IP-classification	20		
Packaging dimensions	L27 x W23.5 x H9 cm (0.01 m ³)		
Packaging weight	1.2 kg		
	Colour	Art. no. / EAN code	Price ex. VAT
	Black	152i205 / 7330492005683	450 EUR
	Silver	152i204 / 7330492005690	450 EUR

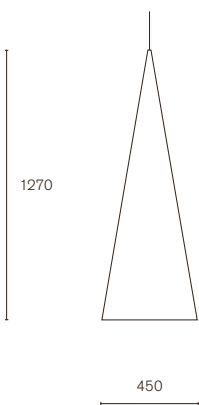
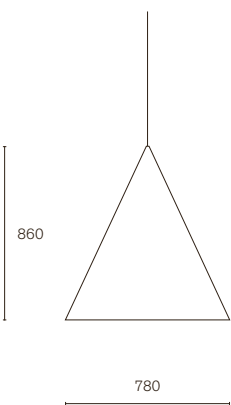
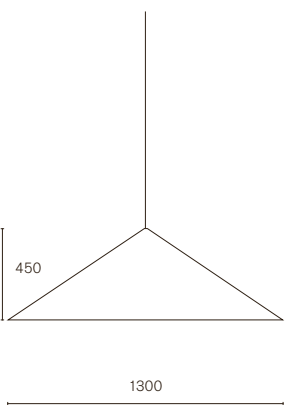
Product name	w151 extra large pendant s1	w151 extra large pendant s2	w151 extra large pendant s3																																				
Dimensions (mm)																																							
Model	Pendant lamp	Pendant lamp	Pendant lamp																																				
Mounting	Steel wire reinforced cable included	Steel wire reinforced cable included	Steel wire reinforced cable included																																				
Material	Aluminium	Aluminium	Aluminium																																				
Cord length	450 cm (cable and wire)	480 cm (cable and wire)	500 cm (cable and wire)																																				
Light source	Integrated LED – included	Integrated LED – included	Integrated LED – included																																				
Watt	19 W	19 W	19 W																																				
Lumen	2750	2750	2750																																				
Lumen/W	145	145	145																																				
Colour temperature	3000 K	3000 K	3000 K																																				
CRI	> 80	> 80	> 80																																				
Light source life expectancy	50.000 h	50.000 h	50.000 h																																				
Light control	Dim/DALI	Dim/DALI	Dim/DALI																																				
Energy class	A++	A++	A++																																				
IP-classification	20	20	20																																				
Packaging dimensions	L55 x W55 x H134 cm (0.4 m³)	L89 x W89 x H93 cm (0.74 m³)	L142 x W142 x H54 cm (1.09 m³)																																				
Packaging weight	10 kg	15 kg	24 kg																																				
	<table border="1"> <thead> <tr> <th>Colour</th> <th>Art. no. / EAN code</th> <th>Price ex. VAT</th> </tr> </thead> <tbody> <tr> <td>Jet black</td> <td>151S19005 / 7330492005430</td> <td>2587 EUR</td> </tr> <tr> <td>Traffic white</td> <td>151S19016 / 7330492005447</td> <td>2587 EUR</td> </tr> <tr> <td>Red orange</td> <td>151S12001 / 7330492005454</td> <td>2587 EUR</td> </tr> </tbody> </table>	Colour	Art. no. / EAN code	Price ex. VAT	Jet black	151S19005 / 7330492005430	2587 EUR	Traffic white	151S19016 / 7330492005447	2587 EUR	Red orange	151S12001 / 7330492005454	2587 EUR	<table border="1"> <thead> <tr> <th>Colour</th> <th>Art. no. / EAN code</th> <th>Price ex. VAT</th> </tr> </thead> <tbody> <tr> <td>Jet black</td> <td>151S29005 / 7330492005461</td> <td>2587 EUR</td> </tr> <tr> <td>Traffic white</td> <td>151S29016 / 7330492005478</td> <td>2587 EUR</td> </tr> <tr> <td>Carmine red</td> <td>151S23002 / 7330492005485</td> <td>2587 EUR</td> </tr> </tbody> </table>	Colour	Art. no. / EAN code	Price ex. VAT	Jet black	151S29005 / 7330492005461	2587 EUR	Traffic white	151S29016 / 7330492005478	2587 EUR	Carmine red	151S23002 / 7330492005485	2587 EUR	<table border="1"> <thead> <tr> <th>Colour</th> <th>Art. no. / EAN code</th> <th>Price ex. VAT</th> </tr> </thead> <tbody> <tr> <td>Jet black</td> <td>151S39005 / 7330492005492</td> <td>3050 EUR</td> </tr> <tr> <td>Traffic white</td> <td>151S39016 / 7330492005508</td> <td>3050 EUR</td> </tr> <tr> <td>Purple red</td> <td>151S33004 / 7330492005515</td> <td>3050 EUR</td> </tr> </tbody> </table>	Colour	Art. no. / EAN code	Price ex. VAT	Jet black	151S39005 / 7330492005492	3050 EUR	Traffic white	151S39016 / 7330492005508	3050 EUR	Purple red	151S33004 / 7330492005515	3050 EUR
Colour	Art. no. / EAN code	Price ex. VAT																																					
Jet black	151S19005 / 7330492005430	2587 EUR																																					
Traffic white	151S19016 / 7330492005447	2587 EUR																																					
Red orange	151S12001 / 7330492005454	2587 EUR																																					
Colour	Art. no. / EAN code	Price ex. VAT																																					
Jet black	151S29005 / 7330492005461	2587 EUR																																					
Traffic white	151S29016 / 7330492005478	2587 EUR																																					
Carmine red	151S23002 / 7330492005485	2587 EUR																																					
Colour	Art. no. / EAN code	Price ex. VAT																																					
Jet black	151S39005 / 7330492005492	3050 EUR																																					
Traffic white	151S39016 / 7330492005508	3050 EUR																																					
Purple red	151S33004 / 7330492005515	3050 EUR																																					

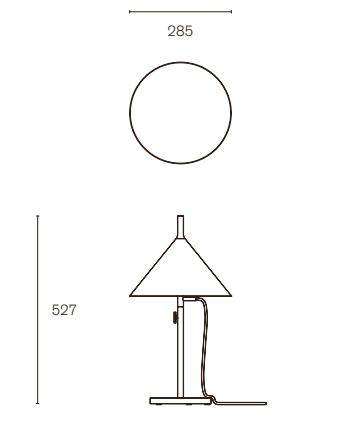
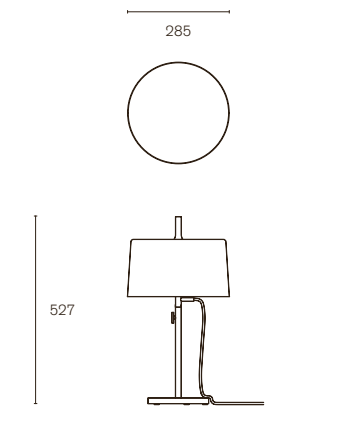
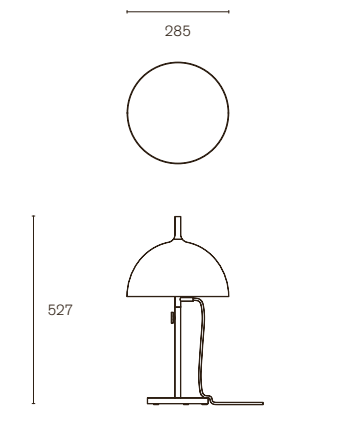
Product name	w132 nendo t1	w132 nendo t2	w132 nendo t3																																				
Dimensions (mm)																																							
Model	Table lamp – cone	Table lamp – cylinder	Table lamp – sphere																																				
Mounting	Base	Base	Base																																				
Material	Steel	Steel	Steel																																				
Cord length	330 cm	330 cm	330 cm																																				
Light source	2 x E14 socket – light source not included	2 x E14 socket – light source not included	2 x E14 socket – light source not included																																				
Watt	Max 40 W	Max 40 W	Max 40 W																																				
Lumen	N/A	N/A	N/A																																				
Colour temperature	N/A	N/A	N/A																																				
CRI	N/A	N/A	N/A																																				
Light source life expectancy	N/A	N/A	N/A																																				
Light control	On/off	On/off	On/off																																				
Energy class	N/A	N/A	N/A																																				
IP-classification	20	20	20																																				
Packaging dimensions	L34 x W30 x H26 cm (0.026 m ³)	L34 x W30 x H26 cm (0.026 m ³)	L34 x W30 x H26 cm (0.026 m ³)																																				
Packaging weight	5 kg	5 kg	5 kg																																				
	<table border="1"> <thead> <tr> <th>Colour</th> <th>Art. no. / EAN code</th> <th>Price ex. VAT</th> </tr> </thead> <tbody> <tr> <td>White</td> <td>132T102 / 7330492006512</td> <td>605 EUR</td> </tr> <tr> <td>Blue</td> <td>132T104 / 7330492006529</td> <td>605 EUR</td> </tr> <tr> <td>Black</td> <td>132T105 / 7330492006536</td> <td>605 EUR</td> </tr> </tbody> </table>	Colour	Art. no. / EAN code	Price ex. VAT	White	132T102 / 7330492006512	605 EUR	Blue	132T104 / 7330492006529	605 EUR	Black	132T105 / 7330492006536	605 EUR	<table border="1"> <thead> <tr> <th>Colour</th> <th>Art. no. / EAN code</th> <th>Price ex. VAT</th> </tr> </thead> <tbody> <tr> <td>White</td> <td>132T202 / 7330492006543</td> <td>605 EUR</td> </tr> <tr> <td>Blue</td> <td>132T204 / 7330492006550</td> <td>605 EUR</td> </tr> <tr> <td>Black</td> <td>132T205 / 7330492006567</td> <td>605 EUR</td> </tr> </tbody> </table>	Colour	Art. no. / EAN code	Price ex. VAT	White	132T202 / 7330492006543	605 EUR	Blue	132T204 / 7330492006550	605 EUR	Black	132T205 / 7330492006567	605 EUR	<table border="1"> <thead> <tr> <th>Colour</th> <th>Art. no. / EAN code</th> <th>Price ex. VAT</th> </tr> </thead> <tbody> <tr> <td>White</td> <td>132T302 / 7330492006574</td> <td>605 EUR</td> </tr> <tr> <td>Blue</td> <td>132T304 / 7330492006581</td> <td>605 EUR</td> </tr> <tr> <td>Black</td> <td>132T305 / 7330492006598</td> <td>605 EUR</td> </tr> </tbody> </table>	Colour	Art. no. / EAN code	Price ex. VAT	White	132T302 / 7330492006574	605 EUR	Blue	132T304 / 7330492006581	605 EUR	Black	132T305 / 7330492006598	605 EUR
Colour	Art. no. / EAN code	Price ex. VAT																																					
White	132T102 / 7330492006512	605 EUR																																					
Blue	132T104 / 7330492006529	605 EUR																																					
Black	132T105 / 7330492006536	605 EUR																																					
Colour	Art. no. / EAN code	Price ex. VAT																																					
White	132T202 / 7330492006543	605 EUR																																					
Blue	132T204 / 7330492006550	605 EUR																																					
Black	132T205 / 7330492006567	605 EUR																																					
Colour	Art. no. / EAN code	Price ex. VAT																																					
White	132T302 / 7330492006574	605 EUR																																					
Blue	132T304 / 7330492006581	605 EUR																																					
Black	132T305 / 7330492006598	605 EUR																																					

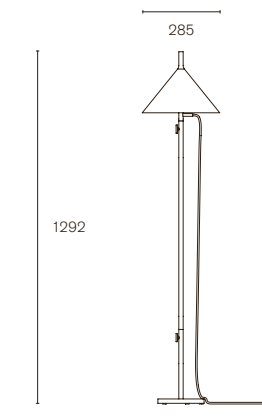
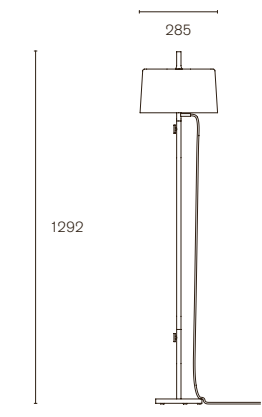
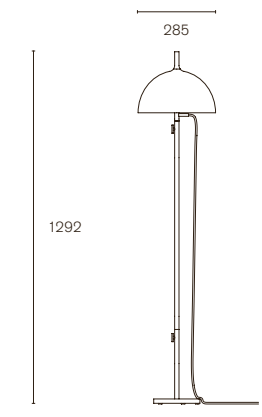
Product name	w132 nendo f1	w132 nendo f2	w132 nendo f3						
Dimensions (mm)									
Model	Floor Lamp – cone	Floor lamp – cylinder	Floor lamp – sphere						
Mounting	Free-standing	Free-standing	Free-standing						
Material	Steel	Steel	Steel						
Cord length	330 cm	330 cm	330 cm						
Light source	2 x E14 socket – light source not included	2 x E14 socket – light source not included	2 x E14 socket – light source not included						
Watt	Max 40 W	Max 40 W	Max 40 W						
Lumen	N/A	N/A	N/A						
Colour temperature	N/A	N/A	N/A						
CRI	N/A	N/A	N/A						
Light source life expectancy	N/A	N/A	N/A						
Light control	On/off	On/off	On/off						
Energy class	N/A	N/A	N/A						
IP-classification	20	20	20						
Packaging dimensions	Box 1: L34 x W30 x H26 cm (0.026 m ³) Box 2: L83 x W5 x H5 cm (0.002 m ³)	Box 1: L34 x W30 x H26 cm (0.026 m ³) Box 2: L83 x W5 x H5 cm (0.002 m ³)	Box 1: L34 x W30 x H26 cm (0.026 m ³) Box 2: L83 x W5 x H5 cm (0.002 m ³)						
Packaging weight	Box 1: 5 kg – Box 2: 0.5 kg	Box 1: 5 kg – Box 2: 0.5 kg	Box 1: 5 kg – Box 2: 0.5 kg						
	Colour	Art. no. / EAN code	Price ex. VAT	Colour	Art. no. / EAN code	Price ex. VAT	Colour	Art. no. / EAN code	Price ex. VAT
	White	132F102 / 7330492006604	727 EUR	White	132F202 / 7330492006635	727 EUR	White	132F302 / 7330492006666	727 EUR
	Blue	132F104 / 7330492006611	727 EUR	Blue	132F204 / 7330492006642	727 EUR	Blue	132F304 / 7330492006673	727 EUR
	Black	132F105 / 7330492006628	727 EUR	Black	132F205 / 7330492006659	727 EUR	Black	132F305 / 7330492006680	727 EUR

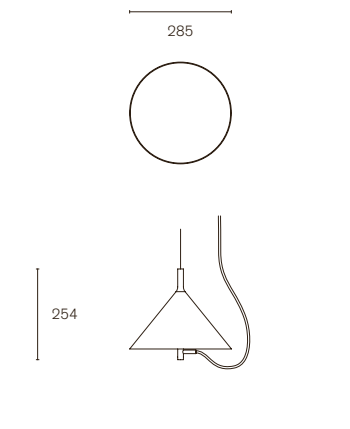
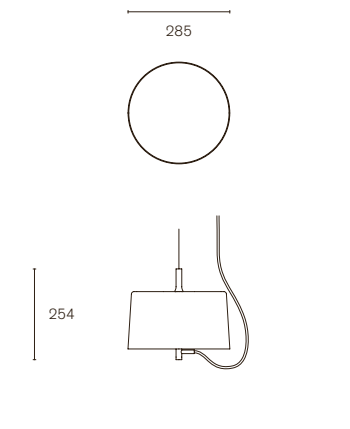
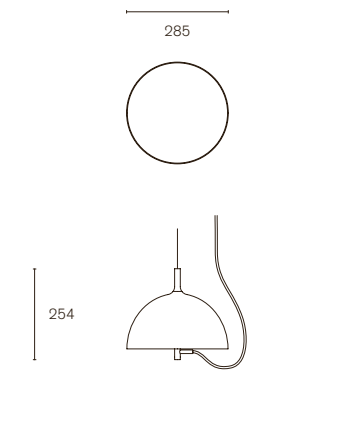
Product name	w132 nendo s1	w132 nendo s2	w132 nendo s3						
Dimensions (mm)									
Model	Pendant lamp – cone	Pendant lamp – cylinder	Pendant lamp – sphere						
Mounting	Steel ceiling attachments with wire gliders – included	Steel ceiling attachments with wire gliders – included	Steel ceiling attachments with wire gliders – included						
Material	Steel	Steel	Steel						
Cord length	280 cm (cable and wire)	280 cm (cable and wire)	280 cm (cable and wire)						
Light source	2 x E14 socket – light source not included	2 x E14 socket – light source not included	2 x E14 socket – light source not included						
Watt	Max 40 W	Max 40 W	Max 40 W						
Lumen	N/A	N/A	N/A						
Colour temperature	N/A	N/A	N/A						
CRI	N/A	N/A	N/A						
Light source life expectancy	N/A	N/A	N/A						
Light control	Dimmable	Dimmable	Dimmable						
Energy class	N/A	N/A	N/A						
IP-classification	20	20	20						
Packaging dimensions	L34 x W30 x H26 cm (0.026 m ³)	L34 x W30 x H26 cm (0.026 m ³)	L34 x W30 x H26 cm (0.026 m ³)						
Packaging weight	2.5 kg	2.5 kg	2.5 kg						
	Colour	Art. no. / EAN code	Price ex. VAT	Colour	Art. no. / EAN code	Price ex. VAT	Colour	Art. no. / EAN code	Price ex. VAT
	White	132S102 / 7330492006697	415 EUR	White	132S202 / 7330492006727	415 EUR	White	132S302 / 7330492006758	415 EUR
	Blue	132S104 / 7330492006703	415 EUR	Blue	132S204 / 7330492006734	415 EUR	Blue	132S304 / 7330492006765	415 EUR
	Black	132S105 / 7330492006710	415 EUR	Black	132S205 / 7330492006741	415 EUR	Black	132S305 / 7330492006772	415 EUR

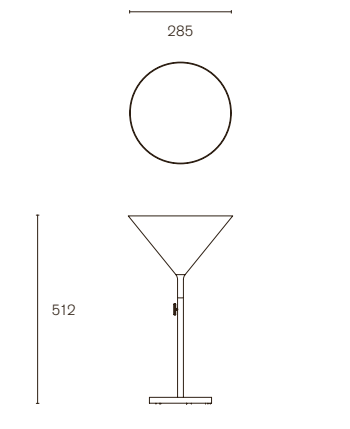
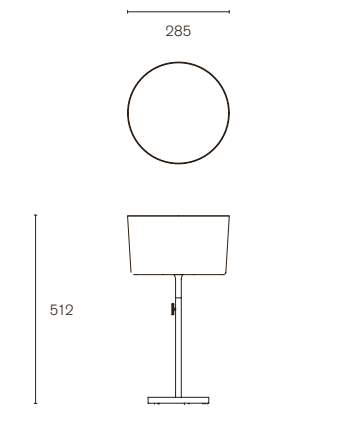
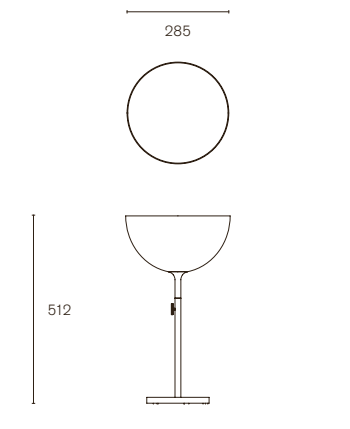
Product name	w132 nendo a1	w132 nendo a2	w132 nendo a3																																													
Dimensions (mm)																																																
Model	Bowl – cone	Bowl – cylinder	Bowl – sphere																																													
Mounting	Free-standing	Free-standing	Free-standing																																													
Material	Steel	Steel	Steel																																													
Cord length	N/A	N/A	N/A																																													
Light source	N/A	N/A	N/A																																													
Watt	N/A	N/A	N/A																																													
Lumen	N/A	N/A	N/A																																													
Colour temperature	N/A	N/A	N/A																																													
CRI	N/A	N/A	N/A																																													
Light source life expectancy	N/A	N/A	N/A																																													
Light control	N/A	N/A	N/A																																													
Energy class	N/A	N/A	N/A																																													
Packaging dimensions	L34 x W30 x H26 cm (0.027 m³)	L34 x W30 x H26 cm (0.027 m³)	L34 x W30 x H26 cm (0.027 m³)																																													
Packaging weight	4.6 kg	5.2 kg	4.8 kg																																													
	<table border="1"> <thead> <tr> <th>Colour</th> <th>Art. no. / EAN code</th> <th>Price ex. VAT</th> </tr> </thead> <tbody> <tr> <td>White</td> <td>132A102 / 7330492006789</td> <td>465 EUR</td> </tr> <tr> <td>Blue</td> <td>132A104 / 7330492006796</td> <td>465 EUR</td> </tr> <tr> <td>Black</td> <td>132A105 / 7330492006802</td> <td>465 EUR</td> </tr> <tr> <td>Pink</td> <td>132A107 / 7330492006819</td> <td>465 EUR</td> </tr> </tbody> </table>	Colour	Art. no. / EAN code	Price ex. VAT	White	132A102 / 7330492006789	465 EUR	Blue	132A104 / 7330492006796	465 EUR	Black	132A105 / 7330492006802	465 EUR	Pink	132A107 / 7330492006819	465 EUR	<table border="1"> <thead> <tr> <th>Colour</th> <th>Art. no. / EAN code</th> <th>Price ex. VAT</th> </tr> </thead> <tbody> <tr> <td>White</td> <td>132A202 / 7330492006826</td> <td>465 EUR</td> </tr> <tr> <td>Blue</td> <td>132A204 / 7330492006833</td> <td>465 EUR</td> </tr> <tr> <td>Black</td> <td>1322205 / 7330492006840</td> <td>465 EUR</td> </tr> <tr> <td>Pink</td> <td>132A207 / 7330492006857</td> <td>465 EUR</td> </tr> </tbody> </table>	Colour	Art. no. / EAN code	Price ex. VAT	White	132A202 / 7330492006826	465 EUR	Blue	132A204 / 7330492006833	465 EUR	Black	1322205 / 7330492006840	465 EUR	Pink	132A207 / 7330492006857	465 EUR	<table border="1"> <thead> <tr> <th>Colour</th> <th>Art. no. / EAN code</th> <th>Price ex. VAT</th> </tr> </thead> <tbody> <tr> <td>White</td> <td>132A302 / 7330492006864</td> <td>465 EUR</td> </tr> <tr> <td>Blue</td> <td>132A304 / 7330492006871</td> <td>465 EUR</td> </tr> <tr> <td>Black</td> <td>132A305 / 7330492006888</td> <td>465 EUR</td> </tr> <tr> <td>Pink</td> <td>132A307 / 7330492006895</td> <td>465 EUR</td> </tr> </tbody> </table>	Colour	Art. no. / EAN code	Price ex. VAT	White	132A302 / 7330492006864	465 EUR	Blue	132A304 / 7330492006871	465 EUR	Black	132A305 / 7330492006888	465 EUR	Pink	132A307 / 7330492006895	465 EUR
Colour	Art. no. / EAN code	Price ex. VAT																																														
White	132A102 / 7330492006789	465 EUR																																														
Blue	132A104 / 7330492006796	465 EUR																																														
Black	132A105 / 7330492006802	465 EUR																																														
Pink	132A107 / 7330492006819	465 EUR																																														
Colour	Art. no. / EAN code	Price ex. VAT																																														
White	132A202 / 7330492006826	465 EUR																																														
Blue	132A204 / 7330492006833	465 EUR																																														
Black	1322205 / 7330492006840	465 EUR																																														
Pink	132A207 / 7330492006857	465 EUR																																														
Colour	Art. no. / EAN code	Price ex. VAT																																														
White	132A302 / 7330492006864	465 EUR																																														
Blue	132A304 / 7330492006871	465 EUR																																														
Black	132A305 / 7330492006888	465 EUR																																														
Pink	132A307 / 7330492006895	465 EUR																																														

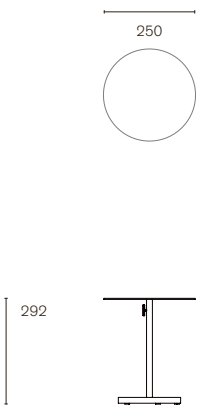
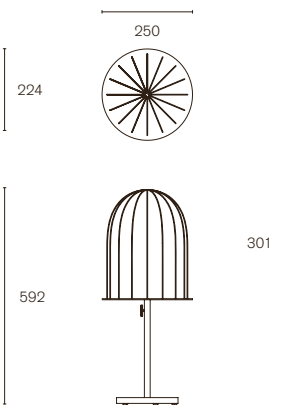

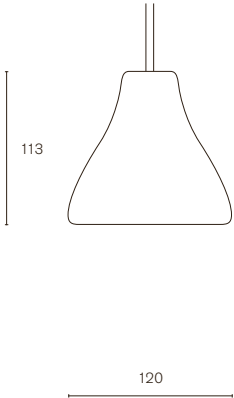
Product name	w132 nendo a4			w132 nendo a5		
Dimensions (mm)						
Model	Table			Birdcage		
Mounting	Free-standing			Free-standing		
Material	Steel			Steel		
Cord length	N/A			N/A		
Light source	N/A			N/A		
Watt	N/A			N/A		
Lumen	N/A			N/A		
Colour temperature	N/A			N/A		
CRI	N/A			N/A		
Light source life expectancy	N/A			N/A		
Light control	N/A			N/A		
Energy class	N/A			N/A		
Packaging dimensions	L34 x W30 x H26 cm (0.027 m³)			Box 1: L34 x W30 x H26 cm (0.027 m³) Box 2: L29 x W29 x H49 cm (0.041 m³)		
Packaging weight	5.2 kg			Box 1: 5.2 kg – Box 2: 2 kg		
	Colour	Art. no. / EAN code	Price ex. VAT	Colour	Art. no. / EAN code	Price ex. VAT
	White	132A402 / 7330492006901	401 EUR	White	132A502 / 7330492006949	1287 EUR
	Blue	132A404 / 7330492006918	401 EUR	Blue	132A504 / 7330492006956	1287 EUR
	Black	132A405 / 7330492006925	401 EUR	Black	132A505 / 7330492006963	1287 EUR
	Pink	132A407 / 7330492006932	401 EUR	Pink	132A507 / 7330492006970	1287 EUR

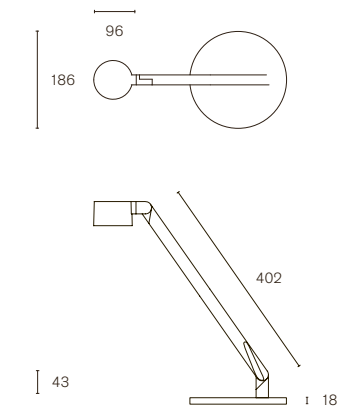
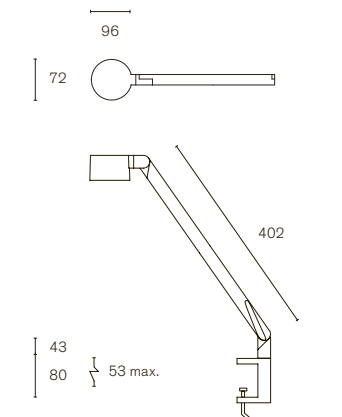
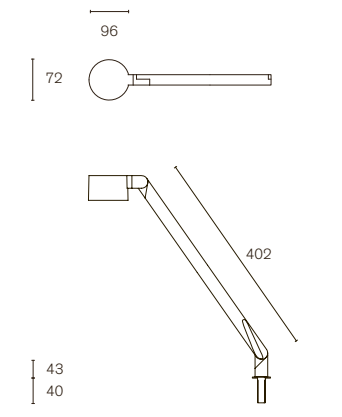
Product name	w131 bell		
Dimensions (mm)			
Model	Pendant lamp		
Mounting	Ceiling rose included		
Material	Aluminium		
Cord length	280 cm, textile cable		
Light source	GU10 socket – light source not included		
Watt	Max 8 W LED		
Lumen	N/A		
Colour temperature	N/A		
CRI	N/A		
Light source life expectancy	N/A		
Light control	Dimmable		
Energy class	N/A		
IP-classification	20		
Packaging dimensions	L16 x W16.5 x H16 cm (0.005 m³)		
Packaging weight	1 kg		
	Colour	Art. no. / EAN code	Price ex. VAT
	Silver grey	131S11111 / 7330492005317	180 EUR
	Pure orange	131S12004 / 7330492005324	180 EUR
	Jet black	131S19005 / 7330492005331	180 EUR
	Zink yellow	131S11018 / 7330492005348	180 EUR
	Beige	131S11001 / 7330492005355	180 EUR
	Traffic red	131S13020 / 7330492005362	180 EUR
	Sapphire blue	131S15003 / 7330492005379	180 EUR
	Grass green	131S16010 / 7330492005386	180 EUR
	Sepia brown	131S18014 / 7330492005393	180 EUR
	Traffic white	131S19016 / 7330492005409	180 EUR

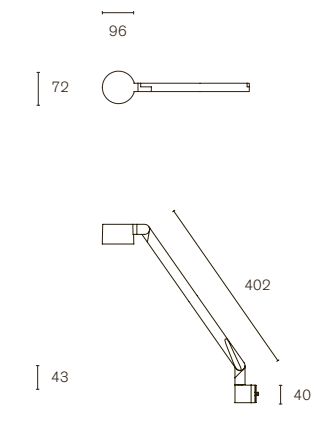
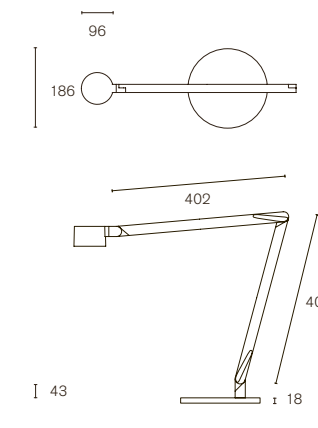
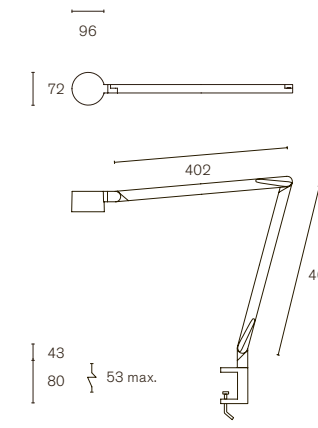
Product name	w127 winkel b1	w127 winkel c1	w127 winkel p1						
Dimensions (mm)									
Model	Table lamp – one arm	Table lamp – one arm	Table lamp – one arm						
Mounting	Base	Clamp	Pin – integrated (cut-out Ø 12mm)						
Material	Solid fiberglass reinforced biopolyamide	Solid fiberglass reinforced biopolyamide	Solid fiberglass reinforced biopolyamide						
Cord length	200 cm	200 cm	200 cm						
Light source	Integrated LED – included	Integrated LED – included	Integrated LED – included						
Watt	6 W	6 W	6 W						
Lumen	1000	1000	1000						
Lumen/W	166	166	166						
Colour temperature	3000 K	3000 K	3000 K						
Colour rendering	CRI 97, GAI 80	CRI 97, GAI 80	CRI 97, GAI 80						
Max colour variation	3 SDCM	3 SDCM	3 SDCM						
Frequency	20.000 Hz	20.000 Hz	20.000 Hz						
Light source life expectancy	50.000 h	50.000 h	50.000 h						
Light control	Dimmable – timer 9 h	Dimmable – timer 9 h	Dimmable – timer 9 h						
Energy class	A++	A++	A++						
IP-classification	20	20	20						
Packaging dimensions	L54 x W38 x H10 cm (0.02 m³)	L54 x W38 x H10 cm (0.02 m³)	L54 x W38 x H10 cm (0.02 m³)						
Packaging weight	5 kg	2 kg	2 kg						
	Colour	Art. no. / EAN code	Price ex. VAT	Colour	Art. no. / EAN code	Price ex. VAT	Colour	Art. no. / EAN code	Price ex. VAT
	White	127B102.2 / 7330492006116	332 EUR	White	127C102.2 / 7330492006154	300 EUR	White	127P102.2 / 7330492006192	300 EUR
	Grey	127B104.2 / 7330492006123	332 EUR	Grey	127C104.2 / 7330492006161	300 EUR	Grey	127P104.2 / 7330492006208	300 EUR
	Black	127B105.2 / 7330492006130	332 EUR	Black	127C105.2 / 7330492006178	300 EUR	Black	127P105.2 / 7330492006215	300 EUR
	Red	127B108.2 / 7330492006147	332 EUR	Red	127C108.2 / 7330492006185	300 EUR	Red	127P108.2 / 7330492006222	300 EUR

Product name	w127 winkel br1	w127 winkel b2	w127 winkel c2																																													
Dimensions (mm)																																																
Model	Table lamp – one arms	Table lamp – two arms	Table lamp – two arms																																													
Mounting	Wall/Rail bracket	Base	Clamp																																													
Material	Solid fiberglass reinforced biopolyamide	Solid fiberglass reinforced biopolyamide	Solid fiberglass reinforced biopolyamide																																													
Cord length	200 cm	200 cm	200 cm																																													
Light source	Integrated LED – included	Integrated LED – included	Integrated LED – included																																													
Watt	6 W	6 W	6 W																																													
Lumen	1000	1000	1000																																													
Lumen/W	166	166	166																																													
Colour temperature	3000 K	3000 K	3000 K																																													
Colour rendering	CRI 97, GAI 80	CRI 97, GAI 80	CRI 97, GAI 80																																													
Max colour variation	3 SDCM	3 SDCM	3 SDCM																																													
Frequency	20.000 Hz	20.000 Hz	20.000 Hz																																													
Light source life expectancy	50.000 h	50.000 h	50.000 h																																													
Light control	Dimmable – timer 9 h	Dimmable – timer 9 h	Dimmable – timer 9 h																																													
Energy class	A++	A++	A++																																													
IP-classification	20	20	20																																													
Packaging dimensions	L54 x W38 x H10 cm (0.02 m³)	L54 x W38 x H10 cm (0.02 m³)	L54 x W38 x H10 cm (0.02 m³)																																													
Packaging weight	2 kg	5 kg	2 kg																																													
	<table border="1"> <thead> <tr> <th>Colour</th> <th>Art. no. / EAN code</th> <th>Price ex. VAT</th> </tr> </thead> <tbody> <tr> <td>White (Black bracket)</td> <td>127BR102.2 / 7330492006239</td> <td>354 EUR</td> </tr> <tr> <td>Grey (Black bracket)</td> <td>127BR104.2 / 7330492006246</td> <td>354 EUR</td> </tr> <tr> <td>Black (Black bracket)</td> <td>127BR105.2 / 7330492006253</td> <td>354 EUR</td> </tr> <tr> <td>Red (Black bracket)</td> <td>127BR108.2 / 7330492006260</td> <td>354 EUR</td> </tr> </tbody> </table>	Colour	Art. no. / EAN code	Price ex. VAT	White (Black bracket)	127BR102.2 / 7330492006239	354 EUR	Grey (Black bracket)	127BR104.2 / 7330492006246	354 EUR	Black (Black bracket)	127BR105.2 / 7330492006253	354 EUR	Red (Black bracket)	127BR108.2 / 7330492006260	354 EUR	<table border="1"> <thead> <tr> <th>Colour</th> <th>Art. no. / EAN code</th> <th>Price ex. VAT</th> </tr> </thead> <tbody> <tr> <td>White</td> <td>127B202.2 / 7330492006277</td> <td>372 EUR</td> </tr> <tr> <td>Grey</td> <td>127B204.2 / 7330492006284</td> <td>372 EUR</td> </tr> <tr> <td>Black</td> <td>127B205.2 / 7330492006291</td> <td>372 EUR</td> </tr> <tr> <td>Red</td> <td>127B208.2 / 7330492006307</td> <td>372 EUR</td> </tr> </tbody> </table>	Colour	Art. no. / EAN code	Price ex. VAT	White	127B202.2 / 7330492006277	372 EUR	Grey	127B204.2 / 7330492006284	372 EUR	Black	127B205.2 / 7330492006291	372 EUR	Red	127B208.2 / 7330492006307	372 EUR	<table border="1"> <thead> <tr> <th>Colour</th> <th>Art. no. / EAN code</th> <th>Price ex. VAT</th> </tr> </thead> <tbody> <tr> <td>White</td> <td>127C202.2 / 7330492006314</td> <td>345 EUR</td> </tr> <tr> <td>Grey</td> <td>127C204.2 / 7330492006321</td> <td>345 EUR</td> </tr> <tr> <td>Black</td> <td>127C205.2 / 7330492006338</td> <td>345 EUR</td> </tr> <tr> <td>Red</td> <td>127C208.2 / 7330492006345</td> <td>345 EUR</td> </tr> </tbody> </table>	Colour	Art. no. / EAN code	Price ex. VAT	White	127C202.2 / 7330492006314	345 EUR	Grey	127C204.2 / 7330492006321	345 EUR	Black	127C205.2 / 7330492006338	345 EUR	Red	127C208.2 / 7330492006345	345 EUR
Colour	Art. no. / EAN code	Price ex. VAT																																														
White (Black bracket)	127BR102.2 / 7330492006239	354 EUR																																														
Grey (Black bracket)	127BR104.2 / 7330492006246	354 EUR																																														
Black (Black bracket)	127BR105.2 / 7330492006253	354 EUR																																														
Red (Black bracket)	127BR108.2 / 7330492006260	354 EUR																																														
Colour	Art. no. / EAN code	Price ex. VAT																																														
White	127B202.2 / 7330492006277	372 EUR																																														
Grey	127B204.2 / 7330492006284	372 EUR																																														
Black	127B205.2 / 7330492006291	372 EUR																																														
Red	127B208.2 / 7330492006307	372 EUR																																														
Colour	Art. no. / EAN code	Price ex. VAT																																														
White	127C202.2 / 7330492006314	345 EUR																																														
Grey	127C204.2 / 7330492006321	345 EUR																																														
Black	127C205.2 / 7330492006338	345 EUR																																														
Red	127C208.2 / 7330492006345	345 EUR																																														

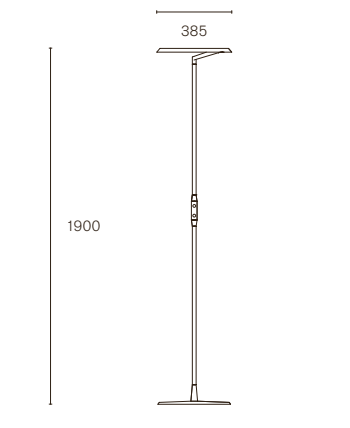
Product name	w127 winkel p2	w127 winkel br2																														
Dimensions (mm)																																
Model	Table lamp – two arms	Table lamp – two arms																														
Mounting	Pin – integrated (cut-out Ø 12 mm)	Wall/Rail bracket																														
Material	Solid fiberglass reinforced biopolyamide	Solid fiberglass reinforced biopolyamide																														
Cord length	200 cm	200 cm																														
Light source	Integrated LED – included	Integrated LED – included																														
Watt	6 W	6 W																														
Lumen	1000	1000																														
Lumen/W	166	166																														
Colour temperature	3000 K	3000 K																														
Colour rendering	CRI 97, GAI 80	CRI 97, GAI 80																														
Max colour variation	3 SDCM	3 SDCM																														
Frequency	20.000 Hz	20.000 Hz																														
Light source life expectancy	50.000 h	50.000 h																														
Light control	Dimmable – timer 9 h	Dimmable – timer 9 h																														
Energy class	A++	A++																														
IP-classification	20	20																														
Packaging dimensions	L54 x W38 x H10 cm (0.02 m³)	L54 x W38 x H10 cm (0.02 m³)																														
Packaging weight	2 kg	2 kg																														
	<table border="1"> <thead> <tr> <th>Colour</th> <th>Art. no. / EAN code</th> <th>Price ex. VAT</th> </tr> </thead> <tbody> <tr> <td>White</td> <td>127P202.2 / 7330492006352</td> <td>345 EUR</td> </tr> <tr> <td>Grey</td> <td>127P204.2 / 7330492006369</td> <td>345 EUR</td> </tr> <tr> <td>Black</td> <td>127P205.2 / 7330492006376</td> <td>345 EUR</td> </tr> <tr> <td>Red</td> <td>127P208.2 / 7330492006383</td> <td>345 EUR</td> </tr> </tbody> </table>	Colour	Art. no. / EAN code	Price ex. VAT	White	127P202.2 / 7330492006352	345 EUR	Grey	127P204.2 / 7330492006369	345 EUR	Black	127P205.2 / 7330492006376	345 EUR	Red	127P208.2 / 7330492006383	345 EUR	<table border="1"> <thead> <tr> <th>Colour</th> <th>Art. no. / EAN code</th> <th>Price ex. VAT</th> </tr> </thead> <tbody> <tr> <td>White (Black bracket)</td> <td>127BR202.2 / 7330492006390</td> <td>394 EUR</td> </tr> <tr> <td>Grey (Black bracket)</td> <td>127BR204.2 / 7330492006406</td> <td>394 EUR</td> </tr> <tr> <td>Black (Black bracket)</td> <td>127BR205.2 / 7330492006413</td> <td>394 EUR</td> </tr> <tr> <td>Red (Black bracket)</td> <td>127BR208.2 / 7330492006420</td> <td>394 EUR</td> </tr> </tbody> </table>	Colour	Art. no. / EAN code	Price ex. VAT	White (Black bracket)	127BR202.2 / 7330492006390	394 EUR	Grey (Black bracket)	127BR204.2 / 7330492006406	394 EUR	Black (Black bracket)	127BR205.2 / 7330492006413	394 EUR	Red (Black bracket)	127BR208.2 / 7330492006420	394 EUR
Colour	Art. no. / EAN code	Price ex. VAT																														
White	127P202.2 / 7330492006352	345 EUR																														
Grey	127P204.2 / 7330492006369	345 EUR																														
Black	127P205.2 / 7330492006376	345 EUR																														
Red	127P208.2 / 7330492006383	345 EUR																														
Colour	Art. no. / EAN code	Price ex. VAT																														
White (Black bracket)	127BR202.2 / 7330492006390	394 EUR																														
Grey (Black bracket)	127BR204.2 / 7330492006406	394 EUR																														
Black (Black bracket)	127BR205.2 / 7330492006413	394 EUR																														
Red (Black bracket)	127BR208.2 / 7330492006420	394 EUR																														

Product name	w126 claesson koivisto rune f	w126 claesson koivisto rune p																								
Dimensions (mm)																										
Model	Floor lamp	Table lamp																								
Mounting	Free-standing	Pin – integrated (cut-out Ø 24 mm)																								
Material	Aluminium	Aluminium																								
Cord length	325 cm	325 cm																								
Light source	Integrated LED – included	Integrated LED – included																								
Watt	85 W	85 W																								
Lumen	10.500	10.500																								
Lumen/W	124	124																								
Colour temperature	3000 K	3000 K																								
CRI	> 85	> 85																								
Light source life expectancy	50.000 h	50.000 h																								
Light control	Separate dimming upwards/downwards	Separate dimming upwards/downwards																								
Energy class	A++	A++																								
IP-classification	20	20																								
Packaging dimensions	L92 x W48 x H16 cm (0.706 m³)	L92 x W48 x H16 cm (0.706 m³)																								
Packaging weight	8 kg	5.5 kg																								
	<table border="1"> <thead> <tr> <th>Colour</th> <th>Art. no. / EAN code</th> <th>Price ex. VAT</th> </tr> </thead> <tbody> <tr> <td>White</td> <td>126F202 / 7330492005225</td> <td>1197 EUR</td> </tr> <tr> <td>Grey</td> <td>126F204 / 7330492005232</td> <td>1197 EUR</td> </tr> <tr> <td>Orange</td> <td>126F209 / 7330492005249</td> <td>1197 EUR</td> </tr> </tbody> </table>	Colour	Art. no. / EAN code	Price ex. VAT	White	126F202 / 7330492005225	1197 EUR	Grey	126F204 / 7330492005232	1197 EUR	Orange	126F209 / 7330492005249	1197 EUR	<table border="1"> <thead> <tr> <th>Colour</th> <th>Art. no. / EAN code</th> <th>Price ex. VAT</th> </tr> </thead> <tbody> <tr> <td>White</td> <td>126P202 / 7330492005287</td> <td>1118 EUR</td> </tr> <tr> <td>Grey</td> <td>126P204 / 7330492005294</td> <td>1118 EUR</td> </tr> <tr> <td>Orange</td> <td>126P209 / 7330492005300</td> <td>1118 EUR</td> </tr> </tbody> </table>	Colour	Art. no. / EAN code	Price ex. VAT	White	126P202 / 7330492005287	1118 EUR	Grey	126P204 / 7330492005294	1118 EUR	Orange	126P209 / 7330492005300	1118 EUR
Colour	Art. no. / EAN code	Price ex. VAT																								
White	126F202 / 7330492005225	1197 EUR																								
Grey	126F204 / 7330492005232	1197 EUR																								
Orange	126F209 / 7330492005249	1197 EUR																								
Colour	Art. no. / EAN code	Price ex. VAT																								
White	126P202 / 7330492005287	1118 EUR																								
Grey	126P204 / 7330492005294	1118 EUR																								
Orange	126P209 / 7330492005300	1118 EUR																								

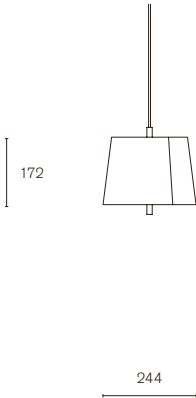
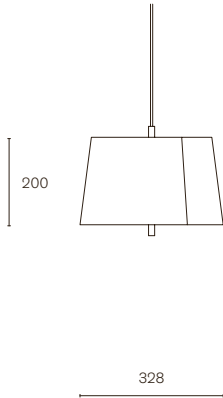
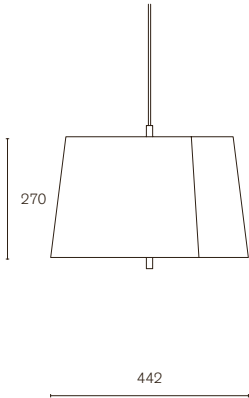
Product name	w124 lindvall s1	w124 lindvall s2	w124 lindvall s3																																				
Dimensions (mm)																																							
Model	Pendant Lamp – small	Pendant Lamp – medium	Pendant Lamp – large																																				
Mounting	Ceiling rose – included	Ceiling rose – included	Ceiling rose – included																																				
Material	Solid copper, solid brass or steel	Solid copper, solid brass or steel	Solid copper, solid brass or steel																																				
Cord length	300 cm, textile cable	300 cm, textile cable	300 cm, textile cable																																				
Light source	2 x E14 socket – light source not included	3 x E14 socket – light source not included	3 x E27 socket – light source not included																																				
Watt	Max 40 W	Max 40 W	Max 40 W																																				
Lumen	N/A	N/A	N/A																																				
Colour temperature	N/A	N/A	N/A																																				
CRI	N/A	N/A	N/A																																				
Light source life expectancy	N/A	N/A	N/A																																				
Light control	Dimmable	Dimmable	Dimmable																																				
Energy class	N/A	N/A	N/A																																				
Packaging dimensions	L29 x W29 x H31 cm (0.026 m ³)	L39 x W39 x H35 cm (0.05 m ³)	L50 x W50 x H42 cm (0.10 m ³)																																				
Packaging weight	WIP	WIP	WIP																																				
	<table border="1"> <thead> <tr> <th>Colour</th> <th>Art. no. / EAN code</th> <th>Price ex. VAT</th> </tr> </thead> <tbody> <tr> <td>Copper</td> <td>124S101 / 7330492005713</td> <td>646 EUR</td> </tr> <tr> <td>Brass</td> <td>124S102 / 7330492005720</td> <td>635 EUR</td> </tr> <tr> <td>White</td> <td>124S103 / 7330492005737</td> <td>593 EUR</td> </tr> </tbody> </table>	Colour	Art. no. / EAN code	Price ex. VAT	Copper	124S101 / 7330492005713	646 EUR	Brass	124S102 / 7330492005720	635 EUR	White	124S103 / 7330492005737	593 EUR	<table border="1"> <thead> <tr> <th>Colour</th> <th>Art. no. / EAN code</th> <th>Price ex. VAT</th> </tr> </thead> <tbody> <tr> <td>Copper</td> <td>124S201 / 7330492005744</td> <td>743 EUR</td> </tr> <tr> <td>Brass</td> <td>124S202 / 7330492005751</td> <td>728 EUR</td> </tr> <tr> <td>White</td> <td>124S203 / 7330492005768</td> <td>664 EUR</td> </tr> </tbody> </table>	Colour	Art. no. / EAN code	Price ex. VAT	Copper	124S201 / 7330492005744	743 EUR	Brass	124S202 / 7330492005751	728 EUR	White	124S203 / 7330492005768	664 EUR	<table border="1"> <thead> <tr> <th>Colour</th> <th>Art. no. / EAN code</th> <th>Price ex. VAT</th> </tr> </thead> <tbody> <tr> <td>Copper</td> <td>124S301 / 7330492005775</td> <td>940 EUR</td> </tr> <tr> <td>Brass</td> <td>124S302 / 7330492005782</td> <td>906 EUR</td> </tr> <tr> <td>White</td> <td>124S303 / 7330492005799</td> <td>789 EUR</td> </tr> </tbody> </table>	Colour	Art. no. / EAN code	Price ex. VAT	Copper	124S301 / 7330492005775	940 EUR	Brass	124S302 / 7330492005782	906 EUR	White	124S303 / 7330492005799	789 EUR
Colour	Art. no. / EAN code	Price ex. VAT																																					
Copper	124S101 / 7330492005713	646 EUR																																					
Brass	124S102 / 7330492005720	635 EUR																																					
White	124S103 / 7330492005737	593 EUR																																					
Colour	Art. no. / EAN code	Price ex. VAT																																					
Copper	124S201 / 7330492005744	743 EUR																																					
Brass	124S202 / 7330492005751	728 EUR																																					
White	124S203 / 7330492005768	664 EUR																																					
Colour	Art. no. / EAN code	Price ex. VAT																																					
Copper	124S301 / 7330492005775	940 EUR																																					
Brass	124S302 / 7330492005782	906 EUR																																					
White	124S303 / 7330492005799	789 EUR																																					

Product name	w124 lindvall t		
Dimensions (mm)			
Model	Table lamp		
Mounting	Base		
Material	Solid copper		
Cord length	280 cm, textile cable		
Light source	2 x E14 socket – light source not included		
Watt	Max 40 W		
Lumen	N/A		
Colour temperature	N/A		
CRI	N/A		
Light source life expectancy	N/A		
Light control	On/off		
Energy class	N/A		
Packaging dimensions	L30 x W30 x H50 cm (0.045 m ³)		
Packaging weight	WIP		
	Colour	Art. no. / EAN code	Price ex. VAT
	Copper	124T101 / 7330492005805	900 EUR

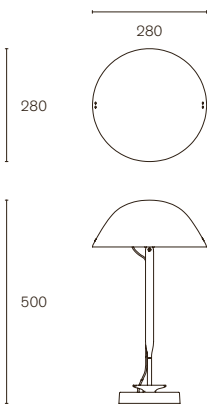
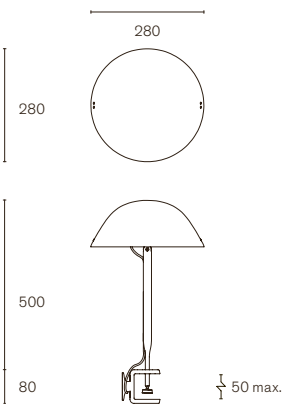
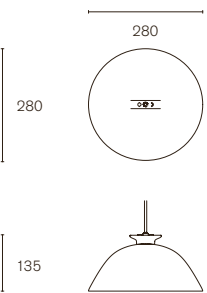
Product name	w103 sempé b	w103 sempé c	w103 sempé s1						
Dimensions (mm)									
Model	Table lamp	Table lamp	Pendant lamp – single shade						
Mounting	Base	Clamp	Ceiling rose included						
Material	Aluminium, steel, cast iron	Aluminium, steel	Aluminium, steel						
Cord length	360 cm	360 cm	300 cm						
Light source	Integrated LED – included	Integrated LED – included	Integrated LED – included						
Watt	7 W	7 W	10 W						
Lumen	661	661	1000						
Lumen/W	94	94	100						
Colour temperature	3000 K	3000 K	2700 K						
CRI	> 92	> 92	> 90						
Light source life expectancy	50.000 h	50.000 h	50.000 h						
Light control	On/Off	On/Off	Dimmable						
Energy class	A+	A+	A+						
IP-classification	20	20	20						
Packaging dimensions	L59 x W34 x H17 cm (0.033 m³)	L59 x W34 x H17 cm (0.033 m³)	L34 x W31 x H20 cm (0.02 m³)						
Packaging weight	5.8 kg	3 kg	2.2 kg						
	Colour	Art. no. / EAN code	Price ex. VAT	Colour	Art. no. / EAN code	Price ex. VAT	Colour	Art. no. / EAN code	Price ex. VAT
	Jet black	103B19005 / 7330492005836	689 EUR	Jet black	103C19005 / 7330492005874	611 EUR	Traffic white	103S19016 / 7330492005911	453 EUR
	Beige red	103B13012 / 7330492005843	689 EUR	Beige red	103C13012 / 7330492005881	611 EUR	Sulfur yellow	103S11016 / 7330492005928	453 EUR
	Traffic white	103B19016 / 7330492005850	689 EUR	Traffic white	103C19016 / 7330492005898	611 EUR	Beige red	103S13012 / 7330492005935	453 EUR
	Reed green	103B16013 / 7330492005867	689 EUR	Reed green	103C16013 / 7330492005904	611 EUR	Coral red	103S13016 / 7330492005942	453 EUR
							Reed green	103S16013 / 7330492005959	453 EUR
							Silver grey	103S17001 / 7330492005966	453 EUR
							Jet black	103S19005 / 7330492005973	453 EUR

Product name	w103 sempé s2	w103 sempé s3					
Dimensions (mm)							
Model	Pendant lamp – two shades on rail	Pendant lamp – three shades on rail					
Mounting	Steel ceiling attachments with wire gliders – included	Steel ceiling attachments with wire gliders – included					
Material	Aluminium, steel	Aluminium, steel					
Cord length	300 cm (cable and wire)	300 cm (cable and wire)					
Light source	Integrated LED – included	Integrated LED – included					
Watt	10 W (per shade)	10 W (per shade)					
Lumen	1000 (per shade)	1000 (per shade)					
Lumen/W	100	100					
Colour temperature	2700 K	2700 K					
CRI	> 90	> 90					
Light source life expectancy	50.000 h	50.000 h					
Light control	Dimmable	Dimmable					
Energy class	A+	A+					
IP-classification	20	20					
Packaging dimensions	L121 x W31 x H21 cm (0.08 m ³)	L121 x W31 x H21 cm (0.08 m ³)					
Packaging weight	4.8 kg	6.2 kg					
	Colour	Art. no. / EAN code	Price ex. VAT	Colour	Art. no. / EAN code	Price ex. VAT	
	Traffic white	103S29016 / 7330492005980	1049 EUR	Traffic white	103S39016 / 7330492006017	1577 EUR	
	Jet black	103S29005 / 7330492005997	1049 EUR	Jet black	103S39005 / 7330492006024	1577 EUR	
	Various/made to order	103S20000 / 7330492006000	1049 EUR	Various/made to order	103S30000 / 7330492006031	1577 EUR	

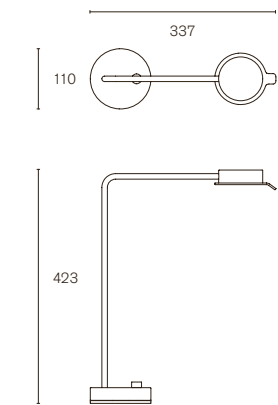
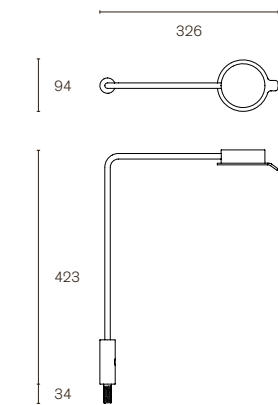
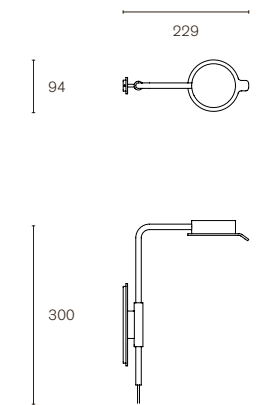
Product name	w 102 chipperfield b	w 102 chipperfield p	w 102 chipperfield w						
Dimensions (mm)									
Model	Table lamp	Pin lamp	Wall lamp						
Mounting	Base	Pin – integrated (cut-out Ø15 mm)	Wall bracket						
Material	Solid brass / black steel	Solid brass / black steel	Solid brass / black steel						
Cord length	180 cm	180 cm	205 cm						
Light source	Integrated LED – included	Integrated LED – included	Integrated LED – included						
Watt	6 W	6 W	6 W						
Lumen	690	690	690						
Lumen/W	115	115	115						
Colour temperature	2700 K	2700 K	2700 K						
CRI	> 90	> 90	> 90						
Max colour variation	3 SDCM	3 SDCM	3 SDCM						
Light source life expectancy	50.000 h	50.000 h	50.000 h						
Light control	Dimmable	Dimmable	Dimmable						
Energy class	A++	A++	A++						
IP-classification	20	20	20						
Packaging dimensions	L51 x W36 x H12 cm (0,02m ³)	L51 x W36 x H12 cm (0,02m ³)	L36 x W30 x H12 cm (0,01m ³)						
Packaging weight	3.3 kg	1.9 kg	1.4 kg						
	Colour	Art. no. / EAN code	Price ex. VAT	Colour	Art. no. / EAN code	Price ex. VAT	Colour	Art. no. / EAN code	Price ex. VAT
	Brass	102T100.2 / 7330492008431	635 EUR	Brass	102P100.2 / 7330492008455	491 EUR	Brass	102W100.2 / 7330492008479	491 EUR
	Black steel	102T105.2 / 7330492008448	635 EUR	Black steel	102P105.2 / 7330492008462	491 EUR	Black steel	102W105.2 / 7330492008486	491 EUR

Product name	w 102 chipperfield f		
Dimensions (mm)			
Model	Floor lamp		
Mounting	Free-standing		
Material	Solid brass / black steel		
Cord length	250 cm		
Light source	Integrated LED – included		
Watt	6 W		
Lumen	690		
Lumen/W	115		
Colour temperature	2700 K		
CRI	> 90		
Max colour variation	3 SDCM		
Light source life expectancy	50.000 h		
Light control	Dimmable		
Energy class	A++		
IP-classification	20		
Packaging dimensions	L118 x W40 x H12 cm (0.06m3)		
Packaging weight	8.4 kg		
	Colour	Art. no. / EAN code	Price ex. VAT
	Brass/black steel	102F005.2 / 7330492008493	902 EUR
	Black steel	102F105.2 / 7330492008509	902 EUR

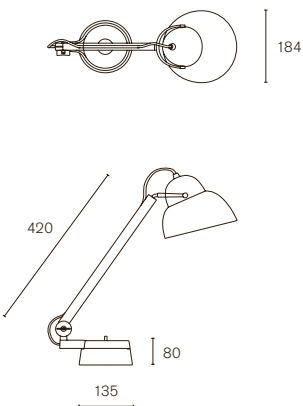
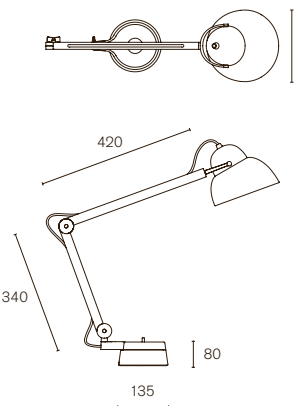
Product name	w084 studioilse t1	w084 studioilse t2				
Dimensions (mm)						
Model	Table lamp – one arm		Table lamp – two arms			
Mounting	Base		Base			
Material	Cast iron, aluminium, beech, PBT		Cast iron, aluminium, beech, PBT			
Cord length	200 cm - textile cable		200 cm - textile cable			
Light source	Halogen IRC, socket: GY 6.35 – included		Halogen IRC, socket: GY 6.35 – included			
Watt	Max 35 W		Max 35 W			
Lumen	670		670			
Lumen/W	19		19			
Colour temperature	3000 K		3000 K			
CRI	100		100			
Light source life expectancy	2000 h		2000 h			
Light control	Dimmable		Dimmable			
Energy class	C		C			
IP-classification	20		20			
Packaging dimensions	L60 x W45 x H20 cm (0,05 m³)		L60 x W45 x H20 cm (0,05 m³)			
Packaging weight	4.0 kg		4.1 kg			
	Colour	Art. no. / EAN code	Price ex. VAT	Colour	Art. no. / EAN code	Price ex. VAT
	Red cable	084T100 / 7330492005522	510 EUR	Red cable	084T200 / 7330492005546	542 EUR
	Brown cable	084T103 / 7330492005539	510 EUR	Brown cable	084T203 / 7330492005553	542 EUR

Terms & Conditions

- 1. General conditions**
- 1.1 These terms and conditions shall apply to all sales and deliveries of products from Wästberg Lighting AB and are included in both Wästberg Lighting AB's quotes and order confirmations as well as in sales agreements between Wästberg Lighting AB and the customer ("Sales Agreement"). Deviating or additional terms and conditions must be accepted in writing by Wästberg Lighting AB in order to apply.
- 1.2 Wästberg Lighting AB has the right to modify, replace or discontinue any product or finishing without prior notice.
- 1.3 By placing an order the customer declares to understand and accept these terms and conditions.
- 2. Prices and payment**
- 2.1 The prices stated in Wästberg Lighting AB's price list exclude VAT and freight.
- 2.3 Payment shall be made in accordance with the terms and conditions of payment as stated on the invoice.
- 2.4 Goods will be dispatched only upon receipt of full payment from the customer unless otherwise agreed.
- 3. Orders etc.**
- 3.1 A Sales Agreement between Wästberg Lighting AB and the customer is generated through Wästberg Lighting AB's written acknowledgement of the customer's order.
- 3.2 When orders are made for goods in accordance with a customer specification, it is the responsibility of the customer to ensure that the applicable specification is complete and accurate as outlined in the order confirmation.
- 3.3 Customers may borrow sample goods for demonstration or testing purposes if the parties agree in writing. Wästberg Lighting AB will charge the customer for the sample goods. Upon return of the sample goods in its original packaging and in flawless condition, within the agreed time, the customer will be credited the amount charged after deducting the freight costs. If the sample goods are returned in deficient condition, i.e. more than normal wear and tear, the customer will be responsible for the costs of repair or new products. Wästberg Lighting AB will decide, in its sole discretion, whether a repair is sufficient or not. If the sample goods are not returned within the agreed time, the customer will not be credited the amount charged.
- 4. Delivery terms**
- 4.1 Wästberg Lighting AB will make all reasonable efforts to deliver the goods within the period stated in the order confirmation. Wästberg Lighting AB will not have any liability to the customer for any delay in delivery.
- 4.2 Ex Works (EXW), Incoterm 2010, will apply to all orders.
- 5. Defects**
- 5.1 The customer will be responsible for inspecting the goods upon delivery.
- 5.2 Any shortage or defect shall be notified in writing to Wästberg Lighting AB within five working days from the delivery date.
- 5.3 Wästberg Lighting AB's liability for defects in the products delivered shall be limited to an obligation to replace defective products with a delivery under the same terms and conditions of delivery. If the parties agree, the customer shall instead receive a reduction in price for the defective products. A product shall be considered defective if it deviates from the specifications stated in the Sales Agreement. Wästberg Lighting AB shall not be responsible for defects that are attributable to materials provided by the customer or to specifications/instructions from the customer.
- 5.4 Any claim for refund resulting from damage caused to products during transportation should be made to the forwarder.
- 6. Returns etc.**
- 6.1 Before a product is returned, approval from Wästberg Lighting AB shall be obtained by the customer. Wästberg Lighting AB will provide the customer with a return item number (the "Return Item Number").
- 6.2 All returns shall be sent to Wästberg Lighting AB in its original packaging and be marked with the Return Item Number. If the return package lacks the Return Item Number, Wästberg Lighting AB will reject the return.
- 6.3 Returns of goods made in accordance with a customer specification are normally not accepted by Wästberg Lighting AB.
- 6.4 If returned goods claimed to be defective are subsequently found not to be defective then a restocking charge of 20% of original price on standard products and 100% on custom made products will be levied in addition to the cost of testing such goods.
- 6.5 If a return is made for other reasons than for claimed defective goods, the customer will be charged a fee of 20% of original price on standard products and 100% on custom made products. Notwithstanding what is stated above, if a returned order of standard products exceeds the normal level in Wästberg Lighting AB's warehouse, a return fee of 50% of original price will be charged. What is stated in this section 7.5 shall also apply in case the customer requests to cancel or change an acknowledged order and Wästberg Lighting AB accept such request.
- 6.6 The customer is responsible for all freight costs in case of return.
- 6.7 Approved returns must be sent by the customer to Wästberg Lighting AB's warehouse within two (2) months from receiving the Return Item Number. Otherwise the customer will not receive any credit or replacement goods, as the case may be, and the customer will lose its right to enforce any remedy applicable under these terms and conditions.
- 7. Warranty**
- 7.1 Wästberg Lighting AB gives a two (2) year warranty - valid from the invoice date - against manufacturing and material defects on all products.
- 7.2 The warranty given above will not apply in case of failure due to normal wear and tear, accidental damage or failure by the customer or any third party to adhere to Wästberg Lighting AB's instructions or written recommendations.
- 7.3 If the conditions above are fulfilled, Wästberg Lighting AB will either repair or replace the products with new fully functional products.
- 7.4 Costs related to troubleshooting, disassembly, electricians and other installation costs cannot be charged to Wästberg Lighting AB.
- 8. Governing law and disputes**
- 8.1 Swedish law shall apply to the terms and conditions and the Sales Agreement. Disputes arising in connection with the terms and conditions or the Sales Agreement shall be settled in court, with Helsingborg District Court as the court of first instance.

Wästberg is a Swedish lighting company aimed at bringing back light to human proximity, by restoring the private spheres man has been deprived of during decades of misguided pursuit of efficiency and standardisation. The universally acclaimed lamps are created in close collaboration with some of the world's most renowned architects, designers and lighting experts, and have earned prestigious awards for their combination of aesthetics, cutting-edge technology and resource conservation.

wästberg

Box 22266
250 24 Helsingborg
Sweden

P+46 42 284 440
info@wastberg.com
wastberg.com