

Resident

EURO Price List 2018



Decorative Lighting

Circus Pendant, 250

Circus is a remarkable system of interconnecting rings.
The rings come in three sizes - 250, 500 and 750mm diameter.
You can specify the Qty of rings
250 diameter = minimum 2 rings, maximum 11 rings

EUR	Circus 250 Brass- Two	€1888	ex tax
	Circus 250 Brass- Three	€2420	ex tax
	Circus 250 Brass- Four	€3193	ex tax
	Circus 250 Brass- Five	€3720	ex tax
	Circus 250 Brass- Six	€4498	ex tax
	Circus 250 Brass- Seven	€5030	ex tax
	Circus 250 Brass- Eight	€5803	ex tax
	Circus 250 Brass- Nine	€6330	ex tax
	Circus 250 Brass- Ten	€7108	ex tax
	Circus 250 Brass- Eleven	€7761	ex tax

Designer	Resident Studio
Year	2018
Description	Pendant Light
Materials	Brushed Brass
Colour Options	Frame - Brushed Brass Cable - Black Canopy - Matt Black

Product Code/ Dimensions	CIR012BR- Circus 250 Brass Two -	L250 x W16 x H500 mm
	CIR013BR- Circus 250 Brass Three -	L250 x W16 x H750 mm
	CIR014BR- Circus 250 Brass Four -	L250 x W16 x H1000 mm
	CIR015BR- Circus 250 Brass Five -	L250 x W16 x H1250 mm
	CIR016BR- Circus 250 Brass Six -	L250 x W16 x H1500 mm
	CIR017BR- Circus 250 Brass Seven -	L250 x W16 x H1750 mm
	CIR018BR- Circus 250 Brass Eight -	L250 x W16 x H2000 mm
	CIR019BR- Circus 250 Brass Nine -	L250 x W16 x H2250 mm
	CIR020BR- Circus 250 Brass Ten -	L250 x W16 x H2500 mm
	CIR021BR- Circus 250 Brass Eleven -	L250 x W16 x H2750 mm

Cable length - Min 300mm/ Max 5000mm
Canopy dimensions - Ø285 x H50mm

Light Source	LED Strip
	Voltage - 24VDC
	Power usage - 19.2W per ring
	Lumens - 2304lm per ring
	Colour temperature - 3000K
	CRI - >95 Average Life Span - 50,000

Standard Driver	24 Volts DC 240W Driver
-----------------	-------------------------

Dimming	DIM001- Dimmer with Remote Control (Included)
	For additional compatible dimmers & drivers that can be purchased separately refer to matrix on page 7 Compatible Options: DIM002, DRI13, DRI17

Certification	CE
---------------	----

Warranty	3 years
----------	---------

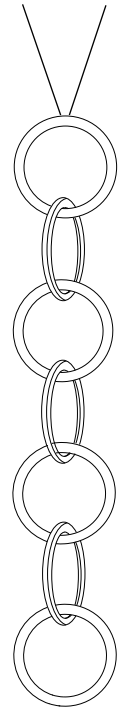

2018
Collection

Circus Pendant, 500

Circus is a remarkable system of interconnecting rings.
The rings come in three sizes - 250, 500 and 750mm diameter.
You can specify the Qty of rings
500 diameter = minimum 2 rings, maximum 6 rings

EUR	Circus 500 Brass- Two	€3490	ex tax
	Circus 500 Brass- Three	€5000	ex tax
	Circus 500 Brass- Four	€6525	ex tax
	Circus 500 Brass- Five	€8050	ex tax
	Circus 500 Brass- Six	€9600	ex tax

Designer	Resident Studio
Year	2018
Description	Pendant Light
Materials	Brushed Brass
Colour Options	Frame - Brushed Brass Cable - Black Canopy - Matt Black
Product Code/ Dimensions	CIR022BR- Circus 500 Brass Two - L500 x W20 x H1000 mm CIR023BR- Circus 500 Brass Three - L500 x W20 x H1500mm CIR024BR- Circus 500 Brass Four - L500 x W20 x H2000 mm CIR025BR- Circus 500 Brass Five - L500 x W20 x H2500mm CIR026BR- Circus 500 Brass Six - L500 x W20 x H3000 mm Cable length - Min 300mm/ Max 5000mm Canopy dimensions - Ø285 x H50mm
Light Source	LED Strip Voltage - 24VDC Power usage - 38.4W per ring Lumens - 4608lm per ring Colour temperature - 3000K CRI - >95 Average Life Span - 50,000
Standard Driver	24 Volts DC 240W Driver
Dimming	DIM001- Dimmer with Remote Control (Included) For additional compatible dimmers & drivers that can be purchased separately refer to matrix on page 7 Compatible Options: DIM002, DRI13, DRI17
Certification	CE
Warranty	3 years

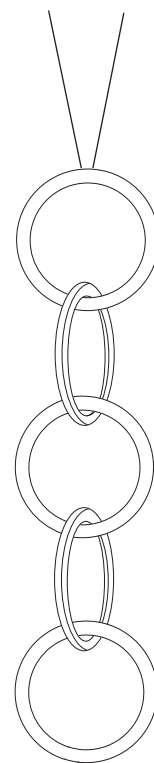

Circus Pendant, 750

Circus is a remarkable system of interconnecting rings.
The rings come in three sizes - 250, 500 and 750mm diameter.
You can specify the Qty of rings
750 diameter = minimum 2 rings, maximum 4 rings

EUR

Circus 750 Brass - Two €3625 ex tax

Circus 750 Brass - Three €5542 ex tax

Circus 750 Brass - Four €7458 ex tax

Designer	Resident Studio
Year	2017
Description	Pendant Light
Materials	Brushed Brass
Colour Options	Frame - Brushed Brass Cable - Black Canopy - Matt Black
Product Code/ Dimensions	CIR032BR- Circus 750 Brass Two - L750 x W20 x H1500mm CIR033BR- Circus 750 Brass Three - L750 x W20 x H2250mm CIR034BR- Circus 750 Brass Four - L750 x W20 x H3000mm Cable length - Min 300mm/ Max 5000mm Canopy dimensions - Ø285 x H50mm
Light Source	LED Strip Voltage - 24VDC Power usage - 57.6W Lumens - 6912lm per ring Colour temperature 3000K CRI - >95 Average Life Span - 50,000
Standard Driver	24 Volts DC 240W Driver
Dimming	DIM001- Dimmer with Remote Control (Included) For additional compatible dimmers & drivers that can be purchased separately refer to matrix on page 7 Compatible Options: DIM002, DRI13, DRI17
Certification	CE
Warranty	3 years

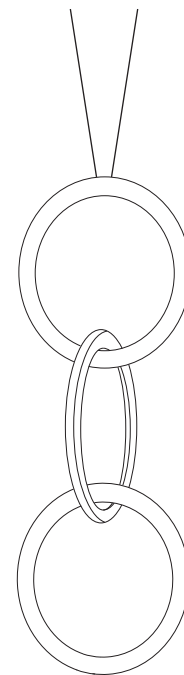

Custom Circus Pendant Configurations

Circus is also designed with the option to be hung in custom configurations.

Please enquire with a Resident sales rep regarding pricing for desired custom configuration

Example configurations from Left to Right

Circus 750 Top and Bottom Ring
250 Middle Ring

Circus 750 Top Ring and 500 Bottom Ring

Circus 500 Top and 2nd Middle Ring
250 1st Middle and Bottom Ring

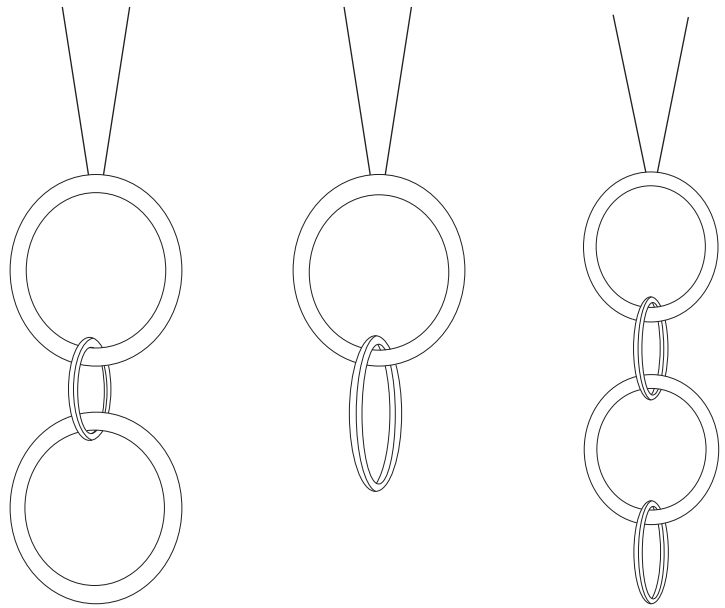

Circus Floor Light

EUR

€6690 ex tax

Designer	Resident Studio
Year	2018
Description	Floor Light
Materials	Brushed Brass
Product Code	CIR045BR
Colour Options	Rings - Brushed Brass Cable - Black Base and Stand - Matt Black
Dimensions	Product dimensions - H1635 x W400 x L400mm Cable length - 2500mm
Light Source	LED Strip Voltage - 24V Power usage - 96W Lumens - 11520lm Colour temperature - 3000K CRI - >95 Average Life Span - 50,000
Standard Driver	24 Volts DC 100W
Dimming	Intergrated Touch Dimming
Certification	CE
Warranty	3 years

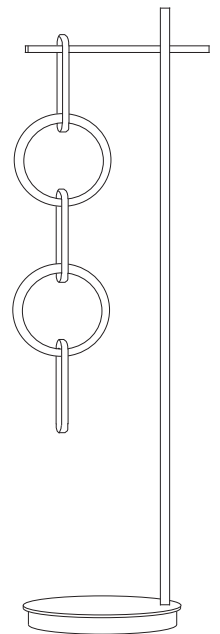

2018
Collection

Midnight Pendant

EUR

**Black
Brushed Aluminium
Brass**

**€5250 ex tax
€6900 ex tax
€8600 ex tax**

Designer	Resident Studio
Year	2016
Description	Pendant Light
Materials	Aluminum
Product Code	MID001B - Midnight Pendant Black MID001A - Midnight Pendant Brushed Aluminium MID001BR - Midnight Pendant Brushed Brass
Colour Options	Frame - Matt Black, Brushed Aluminium, Brushed Brass Cable - Black Canopy - Matt Black
Dimensions	Product dimensions - L1440 x W1440 x H60mm Cable length - Min 300mm/ Max 5000mm Canopy dimensions - Ø285 x H50mm
Light Source	LED Strip Voltage - 24V Power usage - 110W Lumens - 5775lm Colour temperature - 2700K CRI - >95 Average life - 50,000 Hours
Standard Driver	1- 10V 120W Dimmable Driver (PWM)
Dimming	For additional compatible dimmers & drivers that can be purchased separately refer to matrix on page 7 Compatible Options: DIM001, DIM002, DRI13, DRI19
Certification	CE

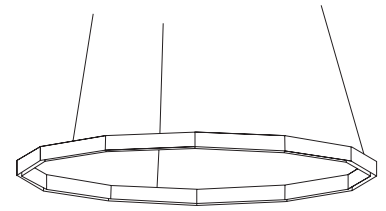

Hex 500

EUR

€1550 ex tax

Designer	Resident Studio
Year	2013
Description	Pendant Light
Materials	Aluminium
Product Code	HEX001B - Hex 500 Black HEX001W - Hex 500 White
Colour Options	Frame - Matt Black, Matt White Cable - Black Canopy - Same as frame
Dimensions	Product dimensions - L470 x W550 x H60mm Cable length - Min 300mm/ Max 2000mm Canopy dimensions - Ø205 x H50mm
Light Source	LED Strip Voltage - 24V Power usage - 30W Lumens - 1680lm Colour temperature - 2700K CRI - >95 Average life span - 50,000 Hours
Standard Driver	24 Volts DC 60W (Not Dimmable)
Dimming	For additional compatible dimmers & drivers that can be purchased separately refer to matrix on page 7 Compatible Options: DIM001, DIM002, DRI06, DRI09, DRI13
Certifications	CE, UL, CUL

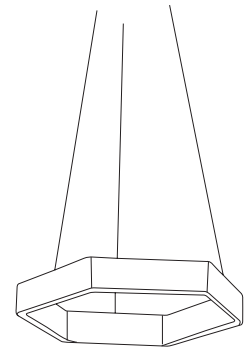

Hex 750

EUR

Black €1990 ex tax
Brass €2800 ex tax

Designer	Resident Studio
Year	2014, 2016
Description	Pendant Light
Materials	Aluminium, Brass
Product Code	HEX002B - Hex 750 Black HEX002BR - Hex 750 Brass
Colour Options	Frame - Matt Black, Brushed Brass Cable - Black Canopy - Matt Black
Dimensions	Product dimensions - L800 x W690 x H60mm Cable length - Min 300mm/ Max 2000mm Canopy dimensions - Ø285 x H50mm
Light Source	LED Strip Voltage - 24V Power usage - 58W Lumens - 1680lm Colour temperature - 2700K CRI - >95 Average life span - 50,000 Hours
Standard Driver	24 Volts DC 100W (Not Dimmable)
Dimming	For additional compatible dimmers & drivers that can be purchased separately refer to matrix on page 7 Compatible Options: DIM001, DIM002, DRI07, DRI10, DRI13
Certifications	CE, UL, CUL

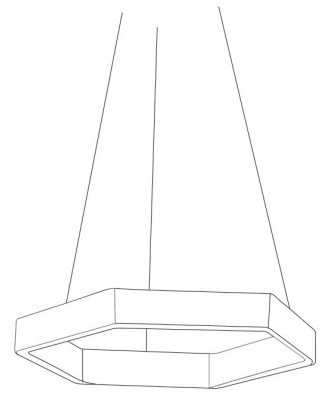

Cross Pendant

EUR

€1695 ex tax

Designer	Resident Studio
Year	2013
Description	Pendant Light
Materials	Aluminium
Product Code	CRO001B - Cross Pendant Black CRO001W - Cross Pendant White
Colour Options	Frame - Matt Black, Matt White Cable - Black Canopy - Same as Frame
Dimensions	Product dimensions - L1000 x W1000 x H60mm Cable length - Min 300mm/ Max 2000mm Canopy dimensions - Ø205 x H50mm
Light Source	LED Strip Voltage - 24V Power usage - 45W Lumens - 2520lm Colour temperature - 2700K CRI - >95 Average life span - 50,000 Hours
Standard Driver	24 Volts DC 60W (Not Dimmable)
Dimming	For additional compatible dimmers & drivers that can be purchased separately refer to matrix on page 7 Compatible Options: DIM001, DIM002, DRI06, DRI09, DRI13
Certifications	CE, UL, CUL

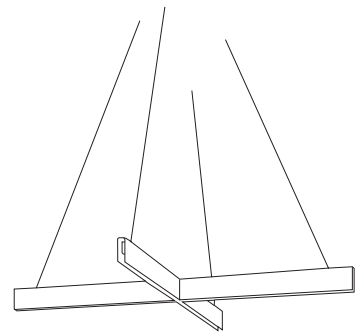

Tri Pendant

EUR

Black €1750 ex tax
Brass €1990 ex tax

Designer	Resident Studio
Year	2014, 2016
Description	Pendant Light
Materials	Aluminium, Brass
Product Code	TRI001B - Tri Pendant Black TRI001BR - Tri Pendant Brass
Colour Options	Frame - Brushed Brass, Matt Black Cable - Black Canopy - Matt Black
Dimensions	Product Dimensions - L750 x W820 x H60mm Cable length - Min 300mm/ Max 2000mm Canopy Dimensions - Ø205 x H50mm
Light Source	LED Strip Voltage - 24V Power usage - 30W Lumens - 1400lm Colour temperature - 2700K CRI - >95 Average life span - 50,000 Hours
Standard Driver	24 Volts DC 60W (Not Dimmable)
Dimming	For additional compatible dimmers & drivers that can be purchased separately refer to matrix on page 7 Compatible Options: DIM001, DIM002, DRI06, DRI09, DRI13
Certifications	CE, UL, CUL

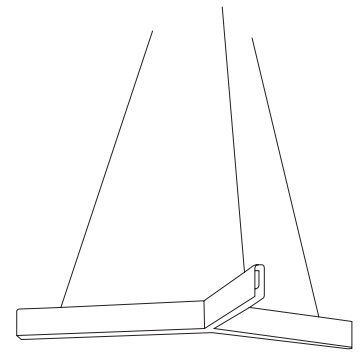

V- Wall Light

EUR

€1995 ex tax

Designer	Resident Studio
Year	2015
Description	Wall Light
Materials	Brass
Product Code	VWL001
Colour Options	Brushed Brass
Dimensions	Product Dimensions - L540 x W590 x H50mm Wall Panel Dimensions - L72 x W123 x H7.93mm
Light Source	LED Strip Voltage - 24V Power usage - 46.5W Lumens - 3675lm Colour temperature - 2700K CRI - >95 Average life - 50,000 hours
Standard Driver	24 Volts DC 60W (Not Dimmable)
Dimming	For additional compatible dimmers & drivers that can be purchased separately refer to matrix on page 7 Compatible Options: DIM001, DIM002, DRI06, DRI09, DRI13
Certification	CE, UL, cUL

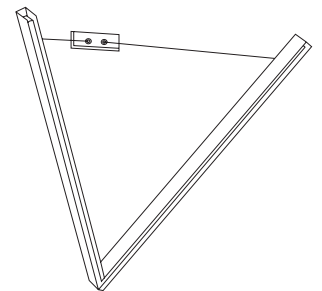

Additional Dimmers & Dimmable Drivers

Code	Price	Type	Product Compatability	Dimmer Compatability
DIM001	€80	Dimmer with Remote	Hex 500. Hex 750 Cross. Tri. V Wall Light Circus 250. 500. 750	Standard Geometric/ Circus Drivers
DIM002	€80	Dimmer with Wall Switch	Hex 500. Hex 750 Cross. Tri. V Wall Light Circus 250. 500. 750	Standard Geometric/ Circus Drivers
DRI06	€80	60W / 0-10V Dimmable Driver (PMW)	Hex 500 Cross. Tri. V Wall Light	DC Dimming
DRI07	€80	90W / 0-10V Dimmable Driver (PMW)	Hex 750	DC Dimming
DRI09	€80	60W Dimmable Phase Cut Driver EU	Hex 500 Cross. Tri. V Wall Light	Universal AC Dimming or Triac Dimming
DRI10	€130	100W Dimmable Phase Cut Driver EU	Hex 750	Universal AC Dimming or Triac Dimming
DRI13	€80	75W Dimmable Dali Driver	Hex 500. Hex 750 Cross. Tri. V Wall Light Circus 250. 500. 750	Dali Systems
DRI17	€250	240W Dimmable Driver Phase Cut EU	Circus 250. 500. 750	Universal AC Dimming or Triac Dimming
DRI19	€180	150W Dimmable Driver Phase Cut EU	Midnight	Universal AC Dimming or Triac Dimming

Notes

Circus 250, 500, 750 pendants come standard with dimmer with remote control (DIM001)

Midnight pendant comes standard with 120 w (Dimmable) driver

Hex 500, Cross, Tri, V wall light come standard with 60 w (non Dimmable) driver

Hex 750 comes standard with 100 w (non Dimmable) driver

All above price listed dimmers & drivers are a separate purchase, they are a flat ex-vat price no discounts to be applied
Any dimmers & drivers required not listed above will need to be either quoted separately or sourced by the client

Mesh Space Pendant

EUR

€2350 ex tax

Designer	Flynn Talbot
Year	2015
Description	Pendant Light
Materials	Aluminium
Product Code	MSP001
Colour Options	Shade - Anodised Gold Cable - Black Canopy - Matt Black
Dimensions	Product dimensions - L600 x W600 x H130mm Cable Length - Min 300mm/ Max 3000mm Canopy Dimensions - Ø205 x H45mm
Light Source	LED Strip Voltage - 24V Power usage - 35.4W Lumens - 2470lm CRI - >90 Colour temperature - 2700K Average life span - 50,000 Hours
Standard Driver	1 - 10V 35.4W Dimmable Driver
Certification	CE

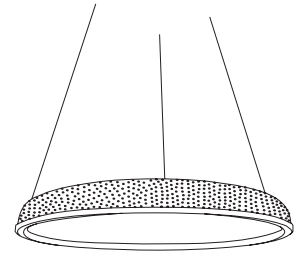

Mesh Space Wall Light

EUR

€1050 ex tax

Designer	Flynn Talbot
Year	2015
Description	Wall/ Ceiling Light
Materials	Aluminium
Product Code	MSW001
Colour Options	Anodised Gold
Product Dimensions	L252 x W252 x H140mm
Light Source	LED Strip Voltage - 24V Power usage - 14W Lumens - 1020lm CRI - >90 Colour temperature - 2700K Average life - 50,000 Hours
Standard Driver	1 - 10V Line Dimming
Certification	CE
Warranty	3 years

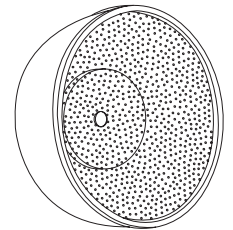

Bloom Pendant

EUR

€430 ex tax

Designer	Tim Rundle
Year	2017
Description	Pendant Light
Materials	Glass/ Stainless Steel
Product Code	BLM001 - Bloom Pendant White BLM002 - Bloom Pendant Black
Colour Options	Shade - Frosted White Glass Cable - Black Canopy and Diffuser - Nickel Plated Shade - Frosted Black Glass Cable - Black Canopy and Diffuser - Chrome Plated
Product Dimensions	Product dimensions - L240 x W240 x H260mm Cable length - Min 300mm/ Max 2000mm Canopy dimensions - D110 x H30mm
Light Source	Halogen Bulb - E27 Voltage - 110-240V Power usage - 42W Lumens - 610lm Colour temperature - 3000K Average life - 2,000 Hours
Dimming	Dimmable Bulb
Certification	CE, UL, CUL

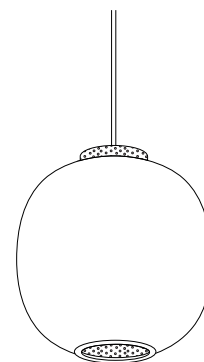

Bloom Table Light

EUR

€430 ex tax

Designer	Tim Rundle
Year	2018
Description	Table Light
Materials	Glass/ Stainless Steel
Product Code	BLM003 - Bloom Table Light White BLM004 - Bloom Table Light Black
Colour Options	Shade - Frosted White Glass Cable - Black Canopy and Diffuser - Nickel Plated Shade - Frosted Black Glass Cable - Black Canopy and Diffuser - Chrome Plated
Product Dimensions	Product dimensions - L240 x W240 x H285mm Cable length - 1800mm
Light Source	Halogen Bulb - E27 Voltage - 110-240V Power usage - 42W Lumens - 610lm Colour temperature - 3000K Average life - 2,000 Hours
Dimming	Dimmable switch
Certification	CE

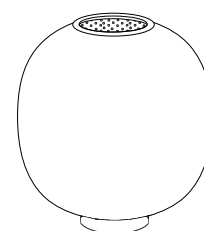

2018
Collection

Parison Pendant

EUR

€850 ex tax

Designer	Cheshire Architects
Year	2014
Description	Pendant Light
Materials	Glass
Product Code	PAR001B - Parison Pendant Black PAR001W - Parison Pendant White
Colour Options	Shade - Black to clear fade Cable - Black Canopy - Matt Black Shade - White to clear fade Cable - White Canopy - Matt White
Dimensions	Product dimensions - L360 x W360 x H350mm Cable Length - Min 300mm/ Max 3000mm Canopy dimensions - Ø100 x H65mm
Light Source	LED Bulb - E27 Power Usage - 6W Lumens - 470 Colour Temperature - 2700K Average Life Span - 25,000 hours
Dimming	Dimmable standard bulb with Parison Black
Certifications	CE, UL

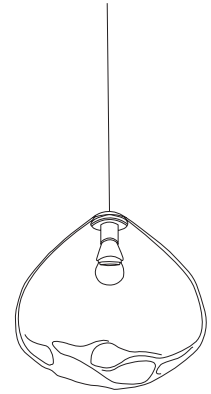

Parison Table Light

EUR

€850 ex tax

Designer	Cheshire Architects
Year	2018
Description	Table Light
Materials	Glass
Product Code	PAR002W
Colour Options	Shade - Matt White Cable - Black Base - Nickel Plated
Dimensions	Product dimensions - L400 x W400 x H310mm Cable Length - 2800mm
Light Source	LED Bulb - E27 Power Usage - 6W Lumens - 470 Colour Temperature - 2700K Average Life Span - 25,000 hours
Dimming	Dimmable switch
Certification	CE

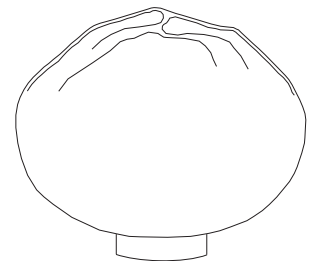

2018
Collection

Fibre Light Bottle

EUR

€2730 ex tax

Designer	Jamie McLellan
Year	2014
Description	Pendant Light
Materials	Carbon Fibre
Product Code	FIB001
Colour Options	Shade - Black Cable - Black Canopy - Black
Dimensions	Product dimensions - Ø 395 x H675mm Cable length - Min 300mm/ Max 3000mm Canopy dimensions - Ø 100 x H65mm
Light Source	LED Bulb -E27 Power usage - 8W
Certifications	CE

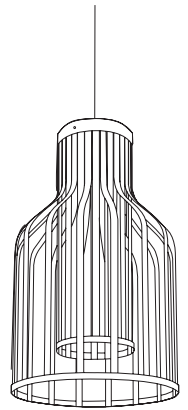

Fibre Light Funnel

EUR

€2730 ex tax

Designer	Jamie McLellan
Year	2014
Description	Pendant Light
Materials	Carbon Fibre
Product Code	FIB002
Colour Options	Shade - Black Cable - Black Canopy - Black
Dimensions	Product dimensions - Ø 590 x H570mm Cable length - Min 300mm/ Max 3000mm Canopy dimensions - Ø 100 x H65mm
Light Source	LED Bulb -E27 Power usage - 8W
Certifications	CE

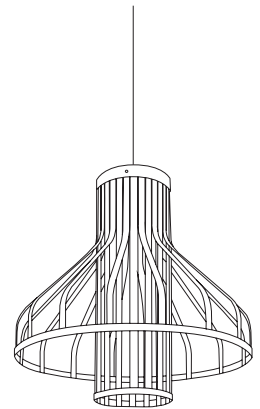

Spar Floor Light

EUR

€1300 ex tax

Designer	Jamie McLellan
Year	2011
Description	Floor Light
Materials	Steel, Aluminium
Product Code	SPF001B
Colour Options	Black with Red cable Black with Black cable
Dimensions	L1460 x W360 x H1870mm
Light Source	LED Bulb - E27 Voltage - 240 V Power usage - 6W Lumens - 470lm Colour temperature - 2700K
Certification	CE

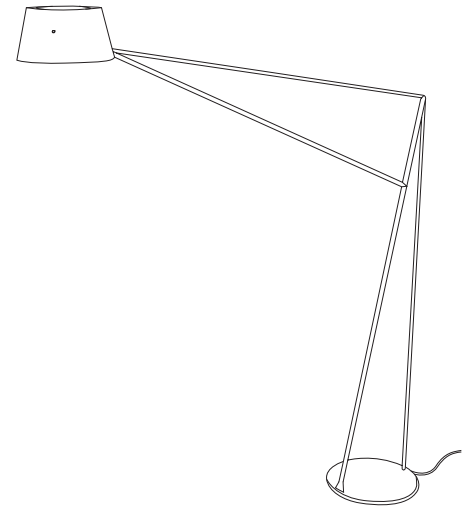

Spar Junior

EUR

€550 ex tax

Designer	Jamie McLellan
Year	2012
Description	Table Light
Materials	Steel, Aluminium
Product Code	SPJ02B
Colour Options	Black with Red cable
Dimensions	L600 x W210 x H725mm
Light Source	LED Bulb - E27 Voltage - 240 V Power usage - 6W Lumens - 470lm Colour temperature - 2700K
Certification	CE

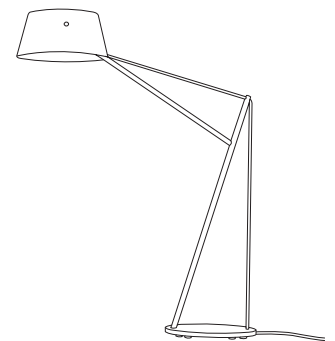

Oud Table Light

EUR

€2990 ex tax

Designer	Cheshire Architects
Year	2012
Description	Table Light
Materials	Stainless Steel, Brass and Marble
Product Code	OULD001BR - Oud Table Light Brass OULD001B - Oud Table Light Black
Colour Options	Frame - Matt Black Marble - Honey Onyx Cable - Black Frame - Brushed Brass Marble - Rossa Levanto Cable - Black
Dimensions	L540 x W330 x H290mm
Light Source	LED Strip Voltage - 24V DC Colour temperature - Warm White 2800K
Certifications	CE

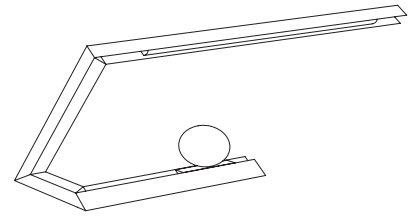

Foundry Floor Light

EUR

€2520 ex tax

Designer	Cheshire Architects
Year	2014
Description	Floor Light
Materials	Cast bronze, Aluminium
Product Code	FOU001
Colour Options	Frame - Matt Black Cable - Black Base - Cast Bronze
Product Dimensions	L280 x W180 x H1900mm
Light Source	LED Strip Voltage - 24V Colour temperature - 2800K
Certifications	CE

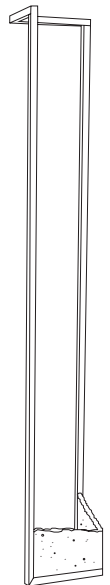

Buster

EUR

€579 ex tax

Designer	Chris Martin/ Massproductions
Year	2018
Description	Table Light
Materials	Nickel Plated Aluminium and Steel
Product Code	BUS001N
Colour Options	Brushed Nickel
Dimensions	Product dimensions - H140 x W573 x D170mm Cable Length - 2500mm
Light Source	LED Voltage - 24V Power usage - 5W Lumens - 250lm CRI - >95 Colour temperature - 3000K Average life - 50,000 hours
Dimming	Touch Dimming
Certification	CE

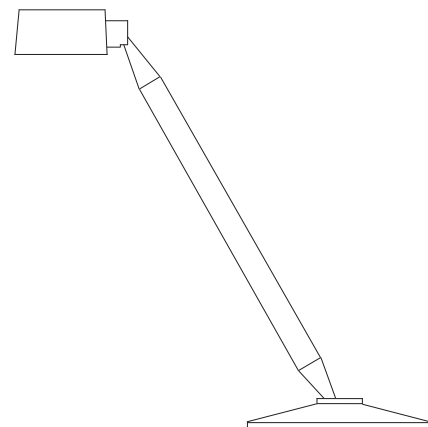

2018
Collection

Torchon Pendant

EUR

€895 ex tax

Designer	Cheshire Architects
Year	2015
Description	Pendant Light
Materials	Glass
Product Code	TOR001
Colour Options	Shade - Clear Cord - Black Canopy - Matt Black
Dimensions	Product dimensions - H250 x W250 x D250mm Cable Length - Min 300mm/ Max 2000mm Canopy dimensions - 100mm
Light Source	Voltage - 24V Power usage - 2.64W Lumens - 133lm CRI - >91 Colour temperature - 2700K Average life - 50,000 hours
Dimming	1 - 10V Line Dimming
Certification	CE

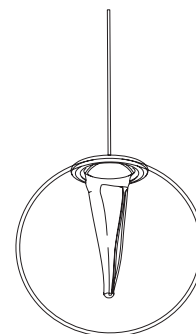

Professional Lighting

Echo Spot - Track

EUR

€510 ex tax

Designer	Flynn Talbot
Year	2016
Description	Track Mount Light
Materials	Aluminium
Product Codes	ECH001
Colour Options	Matt White
Dimensions	L110 x W110 x H170mm
Light Source	Voltage - 24V Lumens - 1000lm CRI - >95 Colour temperature - 3000K, 2700K, 2400K, 2000K Average life - 10 years Dimming - 0-10V Beam Angle - Options of 25°, 36°, 60°, 10 - 36° linear beam spreader, louvre to reduce glare
Certifications	CE

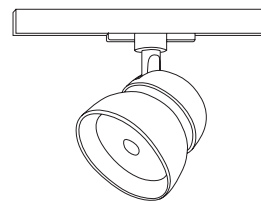

Echo Spot - Surface Mount

EUR

€510 ex tax

Designer	Flynn Talbot
Year	2016
Description	Surface Mount Light
Materials	Aluminium
Product Codes	ECH002
Colour Options	Matt White
Dimensions	L110 x W110 x H140mm
Light Source	Voltage - 24V Lumens - 1000lm CRI - >95 Colour temperature - 3000K, 2700K, 2400K, 2000K Average life - 10 years Dimming - 0-10V Beam Angle - Options of 25°, 36°, 60°, 10 - 36° linear beam spreader, louvre to reduce glare
Certifications	CE



Echo Spot - Pendant

EUR

€510 ex tax

Designer	Flynn Talbot
Year	2016
Description	Pendant Light
Materials	Aluminium
Product Codes	ECH004
Colour Options	Matt White
Dimensions	Product dimensions - L110 x W110 x H130mm Cable dimensions - 2800mm Canopy dimensions - Ø 107 x 35mm
Light Source	Voltage - 24V Lumens - 1000lm CRI - >95 Colour temperature - 3000K, 2700K, 2400K, 2000K Average life - 10 years Dimming - 0-10V Beam Angle - Options of 25°, 36°, 60°, 10 - 36° linear beam spreader, louvre to reduce glare
Certifications	CE

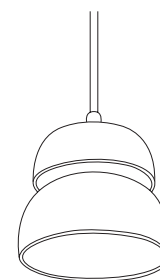

Additional Lenses: Available for Echo Spot

ECH010 - Colour Filter 3000K to 2700K	€20 ex tax
ECH011 - Colour Filter 3000K to 2400K	€20 ex tax
ECH012 - Colour Filter 3000K to 2000K	€20 ex tax
ECH013 - 25 Degree Beam Spreader	€20 ex tax
ECH014 - 36 Degree Beam Spreader	€20 ex tax
ECH015 - 60 Degree Beam Spreader	€20 ex tax
ECH016 - 10-36 Degree Linear Beam Spreader	€20 ex tax
ECH017 - Louvre	€20 ex tax

Please note- Each spot light comes with your choice of colour temperature and beam angle.

Upholstery

Pick Up Sticks

EUR

Category one
Category two
Category three
Category four

€1481 ex tax
€1597 ex tax
€1792 ex tax
€2182 ex tax

Designer	Simon James
Year	2014
Description	Armchair
Materials	Solid Oak/ Upholstery
Product Code	PUS001N - Pick Up Sticks Natural PUS001B - Pick Up Sticks Black
Colour Options	Frame - Natural Oak or Black Stain
Upholstery Options	Category one - Messenger by Maharam Mode by Maharam Category two - Linara by Romo Synergy by Camira Category three - Hallingdale 65 by Kvadrat Category four - Ascona by Pelle Outback by Pelle
Dimensions	Product dimensions - D590 x W610 x H720mm Floor to seat height, including upholstery - 470mm

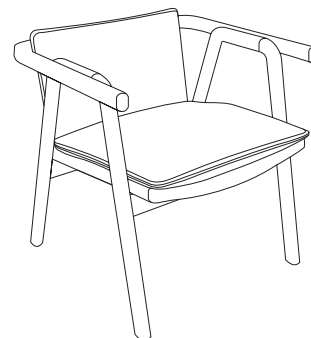

Felix Chair

EUR

Category one
Category two
Category three
Category four

€1091 ex tax
€1208 ex tax
€1403 ex tax
€1807 ex tax

Designer	Simon James
Year	2011
Description	Armchair
Materials	Steel, upholstered plywood and foam
Product Code	FEX001
Colour Options	Frame - Matt Black
Upholstery Options	Category one - Messenger by Maharam Mode by Maharam Category two - Synergy by Camira Category three - Hallingdale 65 by Kvadrat Category four - Ascona by Pelle Outback by Pelle
Dimensions	Product dimensions - D640 x W670 x H770mm Floor to seat height - 450mm

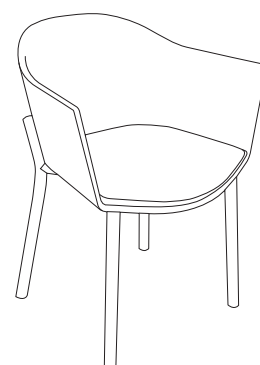

Isabella Chair

EUR

Category one
Category two
Category three
Category four

€1286 ex tax
€1364 ex tax
€1519 ex tax
€2182 ex tax

Designer	Simon James
Year	2018
Description	Armchair
Materials	Timber and Steel frame, Foam inside
Product Code	ISA001
Colour Options	Frame - Matt Black
Upholstery Options	Category one - Messenger by Maharam Category two - Linara by Romo Synergy by Camira Category three - Hallingdale 65 by Kvadrat Category four - Ascona by Pelle Outback by Pelle Mohair supreme by Maharam
Dimensions	Product dimensions - D590 x W670 x H680mm Floor to seat height - 400mm

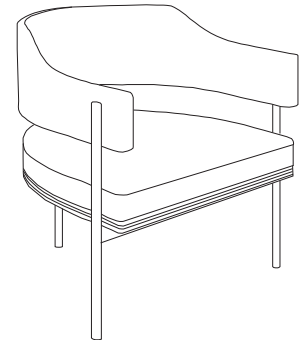

2018
Collection

Carousel Sofa - Low Back

EUR

Category one
Category two
Category four

€ 6974 ex tax
€ 8369 ex tax
€15692 ex tax

Designer	Cameron Foggo
Year	2018
Description	Sofa
Materials	Multi density feather and foam system Timber and Steel frame
Product Code	CAR001
Colour Options	Frame - Matt Black
Upholstery Options	Category one - Messenger by Maharam Mode by Maharam Category two - Linara by Romo Synergy by Camira Category four - Ascona by Pelle
Dimensions	Product dimensions - D810 x W2200 x H600mm Floor to seat height - 400mm

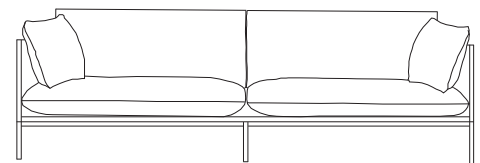

2018
Collection

Carousel Sofa - Mid Back

EUR

Category one
Category two
Category four

€ 7403 ex tax
€ 8883 ex tax
€16656 ex tax

Designer	Cameron Foggo
Year	2018
Description	Sofa
Materials	Multi density feather and foam system Timber and Steel frame
Product Code	CAR002
Colour Options	Frame - Matt Black
Upholstery Options	Category one - Messenger by Maharam Mode by Maharam Category two - Linara by Romo Synergy by Camira Category four - Ascona by Pelle
Dimensions	Product dimensions - D810 x W2200 x H900mm Floor to seat height - 400mm

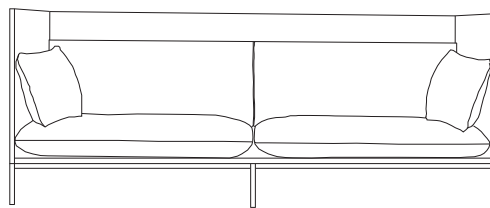

2018
Collection

Carousel Sofa - High Back

EUR

Category one
Category two
Category four

€ 7787 ex tax
€ 9341 ex tax
€17515 ex tax

Designer	Cameron Foggo
Year	2018
Description	Sofa
Materials	Multi density feather and foam system Timber and Steel frame
Product Code	CAR003
Colour Options	Frame - Matt Black
Upholstery Options	Category one - Messenger by Maharam Mode by Maharam Category two - Linara by Romo Synergy by Camira Category four - Ascona by Pelle
Dimensions	Product dimensions - D810 x W2200 x H1350mm Floor to seat height - 400mm

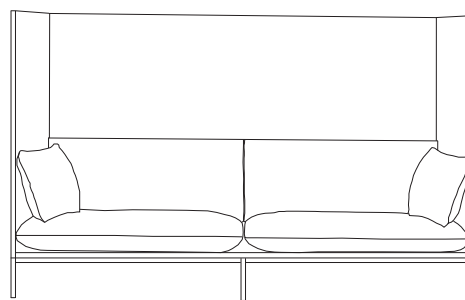

2018
Collection

Arcade Sofa System

EUR

Category one
Category two
Category four

€1332 ex tax
€1532 ex tax
€2207 ex tax

Designer	Simon James
Year	2018
Description	Ottoman
Materials	Multi density feather and foam system Timber frame
Product Code	ARC001
Upholstery Options	Category one - Messenger by Maharam Mode by Maharam Category two - Linara by Romo Synergy by Camira Category four - Ascona by Pelle Mohair Supreme by Maharam
Dimensions	Product dimensions - D900 x W900 x H350mm

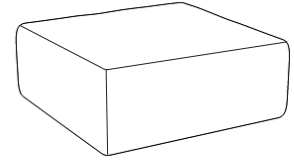

2018
Collection

Arcade Sofa System

EUR

Category one
Category two
Category four

€1636 ex tax
€1882 ex tax
€2710 ex tax

Designer	Simon James
Year	2018
Description	Ottoman with Narrow Arm
Materials	Multi density feather and foam system Timber frame
Product Code	ARC002
Upholstery Options	Category one - Messenger by Maharam Mode by Maharam Category two - Linara by Romo Synergy by Camira Category four - Ascona by Pelle Mohair Supreme by Maharam
Dimensions	Product dimensions - D900 x W1000 x H650mm Floor to seat height - 350mm

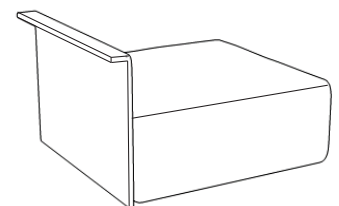

2018
Collection

Arcade Sofa System

EUR

Category one
Category two
Category four

€1854 ex tax
€2132 ex tax
€3071 ex tax

Designer	Simon James
Year	2018
Description	Single Seater No Arm
Materials	Multi density feather and foam system Timber frame
Product Code	ARC003
Upholstery Options	Category one - Messenger by Maharam Mode by Maharam Category two - Linara by Romo Synergy by Camira Category four - Ascona by Pelle Mohair Supreme by Maharam
Dimensions	Product dimensions - D900 x W900 x H650mm Floor to seat height - 350mm

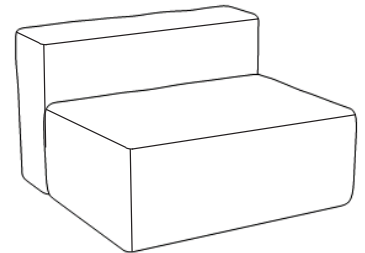

2018
Collection

Arcade Sofa System

EUR

Category one
Category two
Category four

€2416 ex tax
€2779 ex tax
€3605 ex tax

Designer	Simon James
Year	2018
Description	Corner Seat
Materials	Multi density feather and foam system Timber frame
Product Code	ARC004
Upholstery Options	Category one - Messenger by Maharam Mode by Maharam Category two - Linara by Romo Synergy by Camira Category four - Ascona by Pelle Mohair Supreme by Maharam
Dimensions	Product dimensions - D900 x W900 x H650mm Floor to seat height - 350mm

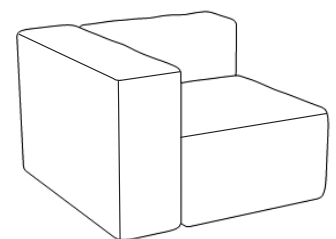

2018
Collection

Arcade Sofa System

EUR

Category one
Category two
Category four

€2074 ex tax
€2375 ex tax
€3434 ex tax

Designer	Simon James
Year	2018
Description	Single Seater Narrow Arm
Materials	Multi density feather and foam system Timber frame
Product Code	ARC005R ARC005L
Upholstery Options	Category one - Messenger by Maharam Mode by Maharam Category two - Linara by Romo Synergy by Camira Category four - Ascona by Pelle Mohair Supreme by Maharam
Dimensions	Product dimensions - D900 x W1000 x H650mm Floor to seat height - 350mm

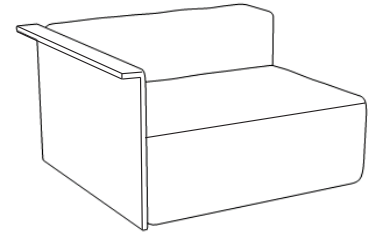

2018
Collection

Arcade Sofa System

EUR

Category one
Category two
Category four

€2592 ex tax
€2981 ex tax
€4292 ex tax

Designer	Simon James
Year	2018
Description	Single Seater Wide Arm
Materials	Multi density feather and foam system Timber frame
Product Code	ARC015R ARC015L
Upholstery Options	Category one - Messenger by Maharam Mode by Maharam Category two - Linara by Romo Synergy by Camira Category four - Ascona by Pelle Mohair Supreme by Maharam
Dimensions	Product dimensions - D900 x W1150 x H650mm Floor to seat height - 350mm

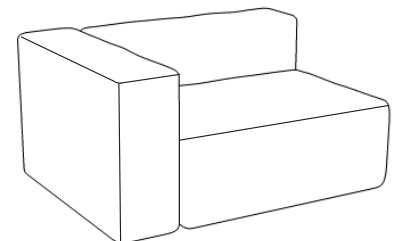

2018
Collection

Arcade Sofa System

EUR

Category one
Category two
Category four

€2645 ex tax
€3042 ex tax
€5136 ex tax

Designer	Simon James
Year	2018
Description	Standard width chaise narrow arm
Materials	Multi density feather and foam system Timber frame
Product Code	ARC006R ARC006L
Upholstery Options	Category one - Messenger by Maharam Mode by Maharam Category two - Linara by Romo Synergy by Camira Category four - Ascona by Pelle Mohair Supreme by Maharam
Dimensions	Product dimensions - D1350 x W1000 x H650mm Floor to seat height - 350mm

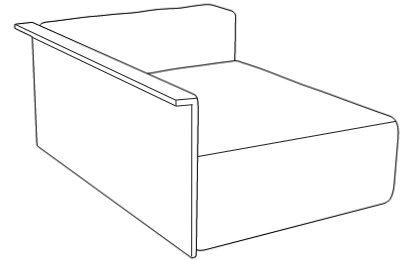

2018
Collection

Arcade Sofa System

EUR

Category one
Category two
Category four

€3223 ex tax
€3707 ex tax
€5338 ex tax

Designer	Simon James
Year	2018
Description	Standard width chaise wide arm
Materials	Multi density feather and foam system Timber frame
Product Code	ARC016R ARC016L
Upholstery Options	Category one - Messenger by Maharam Mode by Maharam Category two - Linara by Romo Synergy by Camira Category four - Ascona by Pelle Mohair Supreme by Maharam
Dimensions	Product dimensions - D1350 x W1150 x H650mm Floor to seat height - 350mm

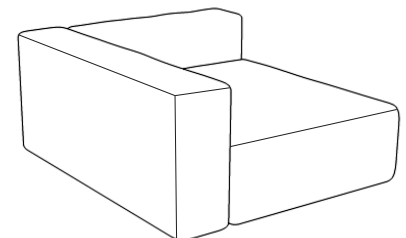

2018
Collection

Arcade Sofa System

EUR

Category one
Category two
Category four

€3102 ex tax
€3567 ex tax
€5136 ex tax

Designer	Simon James
Year	2018
Description	Wide width chaise narrow arm
Materials	Multi density feather and foam system Timber frame
Product Code	ARC007R ARC007L
Upholstery Options	Category one - Messenger by Maharam Mode by Maharam Category two - Linara by Romo Synergy by Camira Category four - Ascona by Pelle Mohair Supreme by Maharam
Dimensions	Product dimensions - D1350 x W1200 x H650mm Floor to seat height - 350mm

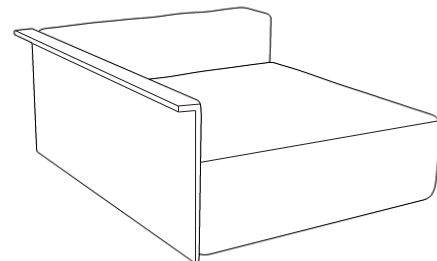

2018
Collection

Arcade Sofa System

EUR

Category one
Category two
Category four

€3680 ex tax
€4232 ex tax
€6095 ex tax

Designer	Simon James
Year	2018
Description	Wide width chaise wide arm
Materials	Multi density feather and foam system Timber frame
Product Code	ARC017R ARC017L
Upholstery Options	Category one - Messenger by Maharam Mode by Maharam Category two - Linara by Romo Synergy by Camira Category four - Ascona by Pelle Mohair Supreme by Maharam
Dimensions	Product dimensions - D1350 x W1350 x H650mm Floor to seat height - 350mm

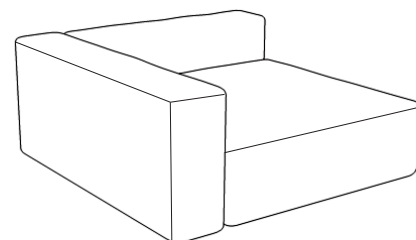

2018
Collection

Arcade Sofa System

EUR

Category one
Category two
Category four

€270 ex tax
€288 ex tax
€363 ex tax

Designer	Simon James
Year	2018
Description	Bolster Cushion
Materials	Foam
Product Code	ARC020
Upholstery Options	Category one - Messenger by Maharam Mode by Maharam Category two - Linara by Romo Synergy by Camira Category four - Ascona by Pelle Mohair Supreme by Maharam
Dimensions	Product dimensions - L508 x W178 x H178mm

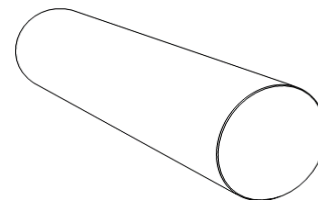

2018
Collection

Arcade Sofa System

EUR

Small

Category one
Category two
Category four

€165 ex tax
€186 ex tax
€253 ex tax

Designer	Simon James
Year	2018
Description	Feather Cushion
Materials	Feather
Product Code	ARC021 - Small Feather ARC022 - Large Feather
Upholstery Options	Category one - Messenger by Maharam Mode by Maharam Category two - Linara by Romo Synergy by Camira Category four - Ascona by Pelle Mohair Supreme by Maharam
Dimensions	Product dimensions Small - L610 x W178 x H381mm Product dimensions large - L584 x W178 x H584mm

Large

Category one
Category two
Category four

€184 ex tax
€203 ex tax
€269 ex tax

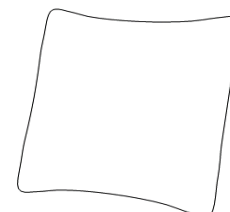
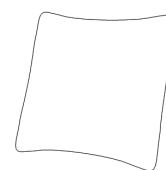

2018
Collection

Odin Chair

EUR

Wooden Seat
Upholstered Seat

€895 ex tax
€995 ex tax

Designer	Jamie McLellan
Year	2016
Description	Armchair
Materials	Cast Aluminium legs, Solid Ash seat and back, Upholstered seat- Kvadrat Maharam Messenger, 458640
Product Code	ODN001N - Odin Chair Natural ODN002NU - Odin Chair Natural Upholstered ODN001B - Odin Chair Black ODN001BU - Odin Chair Black Upholstered
Colour Options	Natural Stain back and seat w Black legs Natural Stain back, upholstered seat w Black legs Black Stain back and seat w Black legs Black Stain back, upholstered seat w Black legs
Dimensions	Product Dimensions - D500 x W600 x H750mm Floor to seat height - 450mm

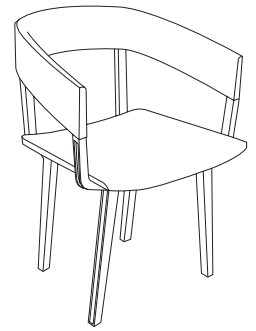

Volley Chair

EUR

Four Leg
Category two

€1091 ex tax

Designer	Jamie McLellan
Year	2016
Description	Lounge Chair
Materials	Upholstered Oak Ply
Product Code	VOL001- Volley Chair with Four Legs VOL002- Volley Chair with Swivel Base
Colour Options	Four Legs - Natural Oak
Upholstery Options	Category two - Linara by Romo Synergy by Camira
Dimensions	Product dimensions - D660 x W620 x H730mm Seat height Swivel Base - 450mm Seat height Four Leg - 370mm

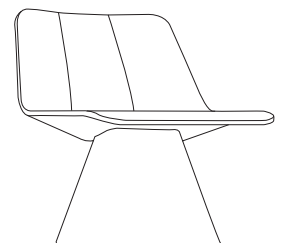
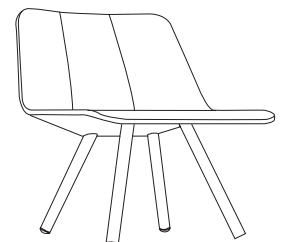

Upholstery Fabric

Messenger by Maharam

78% Post Industry Recycled Polyester, 15% Polyester, 7% Nylon. 100,000 Martindale



Longspur

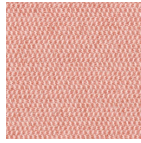

Krill

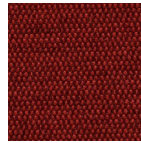

Cherry

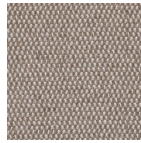

Ash



Tusk



Onyx

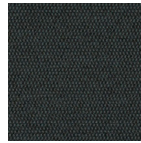

Everglade

Mode by Maharam

80% Post Consumer Recycled Polyester, 20% Polyester. 100,000 Martindale

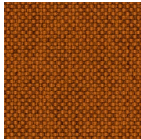

Rust

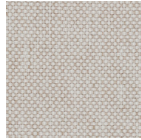

Clavice

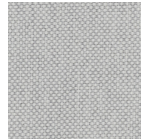

Stroll

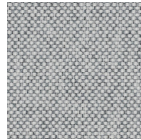

Intagilo

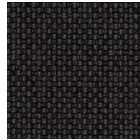

Talus

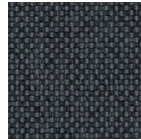

Machine

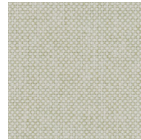

Lichen

Linara by Romo

63% Linen, 37% Cotton. 36,000 Martindale

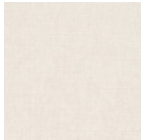

Silver Birch

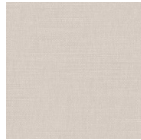

Feather Grey



Taupe



Gravel



Grey Seal



Tarragon

Synergy by Camira

95% Virgin Wool, 5% Polyamide. 100,000 Martindale



Affinity



Affix



Tag

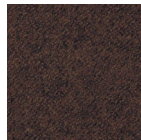

Colelctive

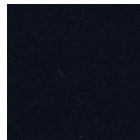

Sync

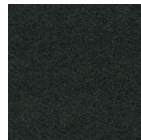

Intertwine

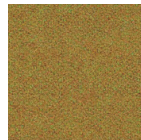

Marry



Serendipity

Hallingdale 65 by Kvadrat

70% New Wool, 30% Viscose. 100,000 Martindale



0227

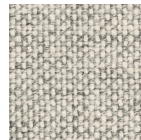

0110

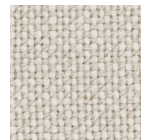

0103

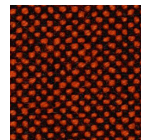

0596

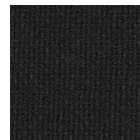

0190

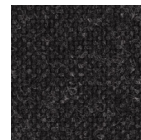

0180

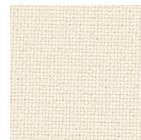

0100

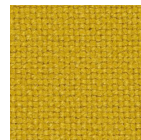

0457

Mohair Supreme by Maharam

100% Mohair. 70,000 Martindale



Stonehenge



Cognac



Cayene



Lupine



Peat

Upholstery Fabric

Outback by Pelle Leather 100% Nubuck Leather



Camboree

Billabong

Broлга

Ascona by Pelle Leather 100% Leather

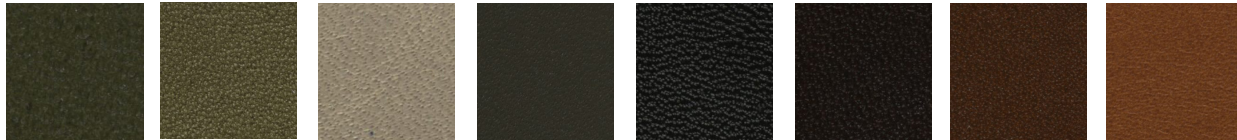

Tapas

Kiwi

Dry Leaf

Rogue

Ebony

Espresso

Dreamtime

Tobacco

Upholstery Fabric Compatability

Category	Supplier	Fabric Name	Pick Up Sticks	Felix	Isabella	Volley	Carousel	Arcade
1	Maharam	Messenger	✓	✓	✓		✓**	✓**
	Maharam	Mode	✓	✓			✓**	✓**
2	Romo	Linara	✓		✓	✓	✓	✓
	Camira	Synergy	✓	✓	✓	✓	✓	✓
3	Kvadrat	Hallingdale 65	✓	✓	✓			
4	Pelle	Ascona*	✓	✓	✓		✓	✓
	Pelle	Outback*	✓	✓	✓			
	Maharam	Mohair Supreme			✓			✓**

All fabrics specified currently meet EN 1021 and either BS 5852 1&2 or Crib 5 - or can be treated to meet these standards.

*Exception of Outback = EN 1021 and Ascona = BS 5852.

**Currently not Available for UK

Ordering Upholstery

Lead Times

Production and delivery lead time will be quoted at time of order, this may be dependent on variable factors per territory including fabric or leather availability. You will be advised of the expected time line at point of order confirmation. Production will only commence when fabric has been received at the factory.

Resident only stock hold Category 1 'Revision' fabric.

Manufacture

Resident have upholstery manufacture hubs in New Zealand, Europe and the USA.

Customer Own Material

Customer Own Material (C.O.M) production lead time will only commence when the fabric has been received at the factory. Payment of fabric and delivery to the factory is the responsibility of the client.

All C.O.M needs to be approved before placement of order. Samples of C.O.M fabric may be requested prior to approval and will need to be sent to the factory to be tested before it is approved.

The client is fully responsible for ensuring the chosen fabric (Resident Specified or C.O.M) is suitable for the intended environment. Resident will not take any responsibility for damage due to improper environmental use.

Fire Safety Requirements

All fabrics specified currently meet EN 1021 and either BS 5852 1&2 or Crib 5 - or can be treated to meet these standards. Exception of Outback = EN 1021 and Ascona = BS 5852. Additional lead times may be quoted at time of order to allow for chemical flame-retardant treatment.

The foam and feather fill that Resident use meets UK fire safety requirements and will be labelled accordingly.

It is the responsibility of the client to advise at point of order the intended usage for the upholstery – i.e. domestic or non-domestic usage as this will determine the treatment required.

If C.O.M fabric is provided by the client is the clients responsibility to ensure it meets the fire safety requirements.

Leather

Leather is a unique natural material, there may be organically occurring imperfections in the hide, these may include growth marks, wrinkles insect bites & slight color variations. All leather will be supplied within commercial tolerance.

Warranty

Resident have a 3-year warranty on the upholstered furniture frames. The guarantee on the upholstery fabric is at the discretion of the fabric provider.

Fabric

Simon James Resident's creative director has selected the seasonal upholstery fabrics and leather color palate. Whilst a select edit per fabric is shown, all colors within the selected ranges are available to order – pending on availability.

Additional information for each fabric including warranty, care and maintenance guidelines, safety certifications can be sourced via the manufacturers websites:

Camira	www.camirafabrics.com
Kvadrat	www.kvadrat.dk
Maharam	www.maharam.com
Pelle Leather	www.pelleleathers.com.au
Romo	www.romo.com

Furniture

Tangerine Chair

EUR

€395 ex tax

Designer	Simon James
Year	2012
Description	Dining Chair
Materials	Solid oak
Product Code	TAN001N - Tangerine Chair Natural TAN001B - Tangerine Chair Black
Colour Options	Natural Oak Black stain *Custom colours available, minimum order qty 50
Dimensions	Product dimensions - D450 x W430 x H750mm Floor to seat height - 460mm

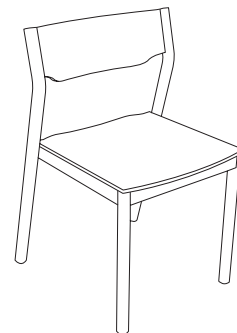

Tangerine Stool

EUR

€320 ex tax

Designer	Simon James
Year	2014
Description	Barstool
Materials	Solid Oak
Product Code	TAN002N - Tangerine Stool Natural TAN002B - Tangerine Stool Black
Colour Options	Natural Oak Black Stain *Custom colours available, minimum order qty 50
Dimensions	Product dimensions - D330 x W370 x H690mm Floor to seat height - 690mm

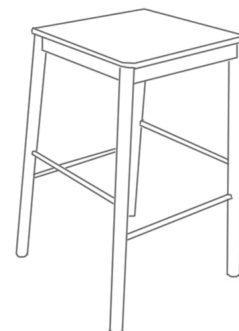

Tangerine Stool with Back

EUR

€410 ex tax

Designer	Simon James
Year	2014
Description	Barstool with back
Materials	Solid Oak
Product Code	TAN003N - Tangerine Stool Natural TAN003B - Tangerine Stool Black
Colour Options	Natural Oak Black Stain *Custom colours available, minimum order qty 50
Dimensions	Product dimensions - D410 x W370 x H875mm Floor to seat height - 700mm

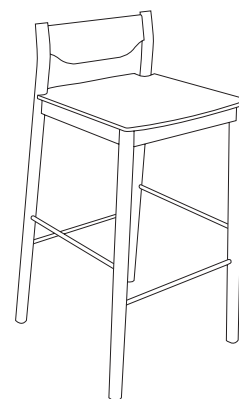

Studio Chair

EUR

€395 ex tax

Designer	Jason Whiteley
Year	2011
Description	Dining Chair
Materials	Solid Oak
Product Code	STC001N - Studio Chair Natural STC001B - Studio Chair Black
Colour Options	Natural Oak Black Stain *Custom colours available, minimum order qty 50
Dimensions	Product dimensions - D420 x W425 x H805mm Floor to seat height - 455mm

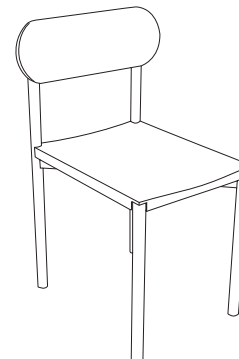

Offset Stool

EUR

€380 ex tax

Designer	Philippe Malouin
Year	2017
Description	Offset Stool/ Sidetable
Materials	Solid oak
Product Code	OFS001 - Offset Stool/ Sidetable
Colour Options	Natural Oak *Custom colours available, minimum order qty 50
Dimensions	L340 x W340 x H430mm

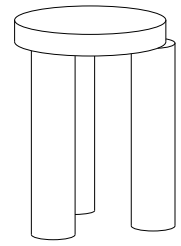

Offset Coffee Table

EUR

€1825 ex tax

Designer	Philippe Malouin
Year	2017
Description	Coffee Table
Materials	Solid Oak
Product Code	OFT001 - Offset Coffee Table
Colour Options	Natural oak *Custom colours available, minimum order qty 50
Dimensions	L900 x W900 x H350mm

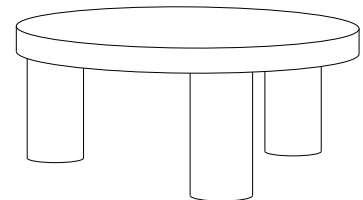

Offset Dining Table

EUR

€4400 ex tax

Designer	Philippe Malouin
Year	2018
Description	Offset Dining Table
Materials	Solid oak
Product Code	OFD001N - Offset Dining Table
Colour Options	Natural Oak
Dimensions	L1600 x W800 x H745mm as standard Top Oak thickness - 65mm Standard size seats six
Custom Dimensions	*Custom length and width sizes available on request Min Length 800mm/Max Length 2800mm Min Width 800mm/ Max Width 1200mm Length and Width sizing is in increments of 100mm

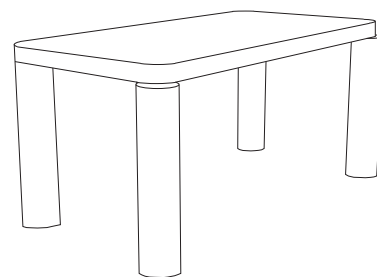

2018
Collection

Interstellar Dining Table

EUR

Black Legs
Stainless Steel Legs

€32400 ex tax
€35000 ex tax

Designer	Resident Studio
Year	2016
Description	Dining Table
Materials	Carbon Fibre, Stainless steel
Product Code	INS001B - Black top, Black legs INS001S - Black top, Stainless Steel legs
Colour Options	Black with Black legs Black with Brushed Stainless Steel legs
Dimensions	L3000 x W950 x H740mm

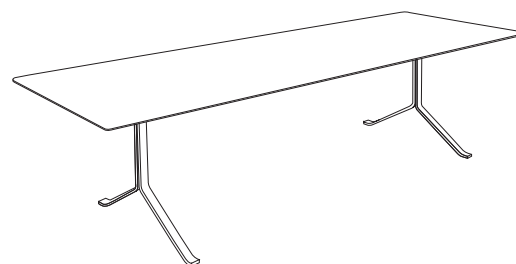

Scholar Table

EUR

€2500 ex tax

Designer	Cameron Foggo
Year	2014
Description	Dining Table
Materials	Solid Ash/ Oak veneer
Product Code	SCH001
Colour Options	Oak veneer/ Black base
Dimensions	L2400 x W900 x H740mm *Custom colours and sizes available upon request

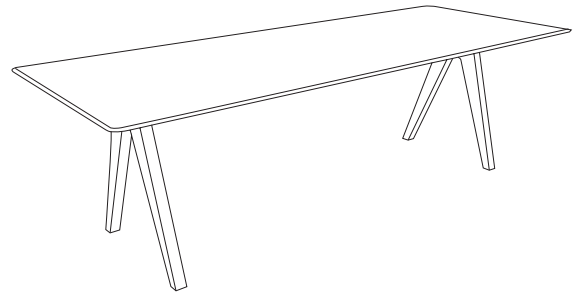

Scholar Bar Leaner

EUR

€2650 ex tax

Designer	Cameron Foggo
Year	2014
Description	Bar Leaner
Materials	Solid Ash/ Oak veneer
Product Code	SCH002
Colour Options	Oak veneer/ Black base
Dimensions	L2400 x W900 x H1000mm *Custom colours and sizes available upon request



Flyover Coffee Table - Long

EUR

€1250 ex tax

Designer	Jamie McLellan
Year	2011
Description	Coffee Table
Materials	Steel
Product Code	FLY001W - Flyover Table Long White FLY001Y - Flyover Table Long Yellow
Colour Options	White Yellow
Dimensions	L1600 x W400 x H300mm

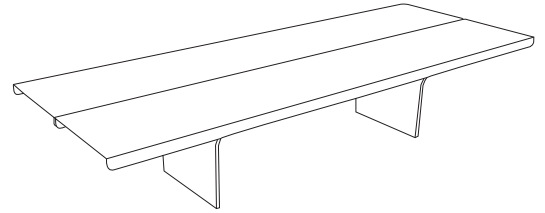

Flyover Coffee Table - Square

EUR

€1250 ex tax

Designer	Jamie McLellan
Year	2011
Description	Coffee Table
Materials	Steel
Product Code	FLY002W
Colour Options	White
Dimensions	L725 x W725 x H300mm

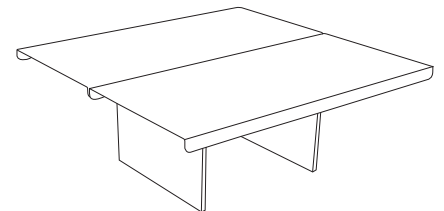

Eccentric Mobile

EUR

€320 ex tax

Designer	Jamie McLellan
Year	2013
Description	Hanging mobile sculpture
Materials	Solid Oak
Product Code	ECC001N - Eccentric Mobile Natural ECC001R - Eccentric Mobile Multicolour
Colour Options	Natural Multicolour
Dimensions	L950 x W35 x H620mm

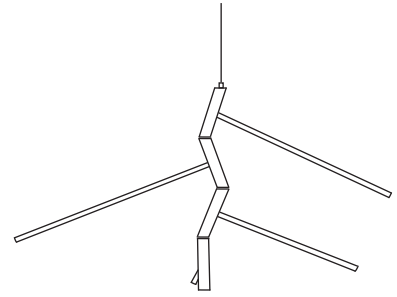

Packing Dimensions

Lighting

Code	Description	Length (cm)	Width (cm)	Height (cm)	CBM	Weight (Kg)
BLM001	Bloom Pendant White	44	44	36	0.070	2.7
BLM002	Bloom Pendant Black	44	44	36	0.070	2.7
BLM003	Bloom Table Light White	44	44	36	0.070	2.7
BLM004	Bloom Table Light Black	44	44	36	0.070	2.7
BUS001N	Buster Table Light Nikel	58	24.5	25	0.036	2.5
CIR012BR	Circus 250 Pendant. 2 Rings (Packaged 2 rings in 1 box)	34	34	9.5	0.011	6.1
CIR013BR	Circus 250 Pendant. 3 Rings (Packaged 2 rings in 1 box)	34	34	9.5	0.011	6.8
CIR014BR	Circus 250 Pendant. 4 Rings (Packaged 2 rings in 1 box)	34	34	19	0.022	8.5
CIR015BR	Circus 250 Pendant. 5 Rings (Packaged 2 rings in 1 box)	34	34	19	0.022	9.2
CIR016BR	Circus 250 Pendant. 6 Rings (Packaged 2 rings in 1 box)	34	34	19	0.022	9.9
CIR017BR	Circus 250 Pendant. 7 Rings (Packaged 2 rings in 1 box)	34	34	28.5	0.033	9.6
CIR018BR	Circus 250 Pendant. 8 Rings (Packaged 2 rings in 1 box)	34	34	28.5	0.033	11.3
CIR019BR	Circus 250 Pendant. 9 Rings (Packaged 2 rings in 1 box)	34	34	28.5	0.033	13
CIR020BR	Circus 250 Pendant. 10 Rings (Packaged 2 rings in 1 box)	34	34	28.5	0.033	14.7
CIR021BR	Circus 250 Pendant. 11 Rings (Packaged 2 rings in 1 box)	34	34	38	0.044	15.4
CIR022BR	Circus 500 Pendant. 2 Rings (Packaged 2 rings in 1 box)	62	55	9.5	0.032	10
CIR1023BR	Circus 500 Pendant. 3 Rings (Packaged 2 rings in 1 box)	62	55	19	0.065	13.3
CIR1024BR	Circus 500 Pendant. 4 Rings (Packaged 2 rings in 1 box)	62	55	28.5	0.097	16.6
CIR1025BR	Circus 500 Pendant. 5 Rings (Packaged 2 rings in 1 box)	62	55	38	0.130	19.9
CIR1026BR	Circus 500 Pendant. 6 Rings (Packaged 2 rings in 1 box)	62	55	57	0.194	23.2
CIR1032BR	Circus 750 Pendant. 2 Rings (Packaged 2 rings in 1 box)	97	87	10	0.084	13.7
CIR1033BR	Circus 750 Pendant. 3 Rings (Packaged 2 rings in 1 box)	97	87	20	0.169	22.2
CIR1034BR	Circus 750 Pendant. 4 Rings (Packaged 2 rings in 1 box)	97	87	30	0.253	26.7
CIR045BR	Circus Floor Light (Box 1 Stem)	168	8.5	6.5	0.009	1
CIR045BR	Circus Floor Light (Box 2 Base)	620	55	19	0.648	18
CRO001B	Cross Pendant Black	97	87	10	0.084	6.5
CRO001W	Cross Pendant White	97	87	10	0.084	6.5
ECH001	Echo Spot/ Track Mount	21.5	21.5	16.5	0.008	1.1
ECH002	Echo Spot/ Surface Mount	21.5	21.5	16.5	0.008	1.2
ECH003	Echo Spot/ Pendant	21.5	21.5	16.5	0.008	1.3
FOU001	Foundry Floor Light (Crated)	227.5	45.5	41.5	0.430	12
FIB001	Fibre Light Bottle	40	40	71	0.114	3.5
FIB002	Fibre Light Funnel	60	60	63	0.227	3.5
HEX001B	Hex Pendant Black	62	55	10	0.034	4.1
HEX001W	Hex Pendant White	62	55	10	0.034	4.1
HEX002B	Hex 750 Black	97	87	10	0.084	6.6
HEX002BR	Hex 750 Brass	97	87	10	0.084	7.3
MID001B	Midnight Pendant Black (Crated)	190	192	20	0.730	57.6
MID001BR	Midnight Pendant Brass (Crated)	190	192	20	0.730	81
MID001S	Midnight Pendant Silver (Crated)	190	192	20	0.730	57.6
MSP001	Mesh Space Pendant	70	70	30	0.147	7.8
MSW001	Mesh Wall Light	31.5	31.5	19.5	0.019	1.5

OU0001B	Oud Lamp Black	58	25	58	0.084	4.5
OU0001BR	Oud Lamp Brass	58	25	58	0.084	4.7
PAR001B	Parison Pendant Black	46	46	47	0.099	5.5
PAR001W	Parison Pendant White	46	46	47	0.099	5.5
PAR002W	Parison Table Light White	41	41	41	0.069	4.6
SPF001B	Spar Light (Base and Shade)	45	23	44	0.046	10.2
SPF001B	Spar Light (Floor Arms)	154	10	4.5	0.007	3.9
SPJ02B	Spar Jnr	76	63	25	0.120	7
TOR001	Torchon Pendant	41	41	42	0.071	4.7
TRI001B	Tri Pendant Black	97	87	10	0.084	5.8
TRI001BR	Tri Pendant Brass	97	87	10	0.084	6.5
VWL001	V Wall Light	97	87	10	0.084	5.5

Upholstery

Code	Description	Length (cm)	Width (cm)	Height (cm)	CBM	Weight (Kg)
ARC001	Arcade Ottoman (Crated)	94.4	95.4	55.2	0.497	54.9
ARC002	Arcade Ottoman Narrow Arm (Crated)	94.4	105.4	85.2	0.848	66.4
ARC003	Arcade Single Seater No Arm (Crated)	99.4	95.4	85.2	0.808	69.6
ARC004	Arcade Corner Seat (Crated)	99.4	95.4	85.2	0.808	77.1
ARC005L	Arcade Single Seater Narrow Arm Left (Crated)	109.4	105.4	85.2	0.982	81.4
ARC005R	Arcade Single Seater Narrow Arm Right (Crated)	109.4	105.4	85.2	0.982	81.4
ARC006L	Arcade Standard Chaise Narrow Arm Left (Crated)	140.4	109.4	85.2	1.309	123.8
ARC006R	Arcade Standard Chaise Narrow Arm Right (Crated)	140.4	109.4	85.2	1.309	123.8
ARC007L	Arcade Wide Chaise Narrow Arm Left (Crated)	140.4	129.4	85.2	1.548	130.2
ARC007R	Arcade Wide Chaise Narrow Arm Right (Crated)	140.4	129.4	85.2	1.548	130.2
ARC015L	Arcade Single Seater Wide Arm Left (Crated)	120	99.4	85.2	1.016	92.9
ARC015R	Arcade Single Seater Wide Arm Right (Crated)	120	99.4	85.2	1.016	92.9
ARC016L	Arcade Standard Chaise Wide Arm Left (Crated)	140.4	124.4	85.2	1.488	131.7
ARC016R	Arcade Standard Chaise Wide Arm Right (Crated)	140.4	124.4	85.2	1.488	131.7
ARC017L	Arcade Wide Chaise Wide Arm Left (Crated)	140.4	144.4	85.2	1.727	141.1
ARC017R	Arcade Wide Chaise Wide Arm Right (Crated)	140.4	144.4	85.2	1.727	141.1
ARC020	Arcade Bolster Round Cushion	Cushions come packaged with the Sofa				
ARC021	Arcade Small Feather Cushion	Cushions come packaged with the Sofa				
ARC022	Arcade Large Feather Cushion	Cushions come packaged with the Sofa				
CAR001	Carousel Sofa Low Back (Crated)	225.4	90.4	64	1.304	162
CAR002	Carousel Sofa Medium Back (Crated)	225.4	90.4	71	1.447	184
CAR003	Carousel Sofa High Back (Crated)	225.4	90.4	82	1.671	210
FEX001	Felix Chair	54	67	65	0.235	11.6
ISA001	Isabella Chair	75	72	77.5	0.419	19
VOL001	Volley Chair 4 leg	72	77	78	0.432	11.2
VOL002	Volley Chair Swivel	72	77	78	0.432	16.7

Furniture

Code	Description	Length (cm)	Width (cm)	Height (cm)	CBM	Weight (Kg)
ECC001N	Eccentric Mobile Natural	8	8	79	0.005	1.2
ECC001R	Eccentric Mobile Red Mix	8	8	79	0.005	1.2
FLY001W	Flyover Coffee Table Long White	150	36	9	0.049	28
FLY001Y	Flyover Coffee Table Long Yellow	150	36	9	0.049	29
FLY002W	Flyover Coffee Table - Square	78	42	10	0.033	26
INS001B	Interstellar Dining Table - Black & Black	328	13	115	0.490	100
INS001S	Interstellar Dining Table - Black & Steel	328	13	115	0.490	100
ODN001B	Odin Chair Black	65	55	84	0.300	9.7
ODN001BU	Odin Chair Black Upholsterd	65	55	84	0.300	9.7
ODN001N	Odin Chair Natural	65	55	84	0.300	9.7
ODN001NU	Odin Chair Natural Upholstered	65	55	84	0.300	9.7
OFD001	Offset Dining table Legs (Box 1)	82	42	42	0.145	36
OFD000	Offset Dining table Top (Box 2)	172	90	14	0.217	57
OFS001	Offset Stool	44	34	15	0.022	8.1
OFT001	OffSet Coffee Table Leg (Box 1)	51	35	17	0.030	11.6
OFT002	Off Set Coffee Table Top (Box 2)	94	94	8.5	0.075	33.4
PUS001B	Pick Up Sticks Chair Black	103	71	69	0.505	14.1
PUS001N	Pick Up Sticks Chair Natural	103	71	69	0.505	14.1
SCH001	Scholar Table	254	18	102	0.466	70
SCH002	Scholar Bar Leaner	254	18	102	0.466	90
STC001B	Studio Chair Black (2 per Box)	85	45	14	0.054	10
STC001N	Studio Chair Natural (2 per Box)	85	45	14	0.054	10
TAN001B	Tangerine Chair Black (4 per Box)	55	69	102	0.387	23.4
TAN001N	Tangerine Chair Natural (4 per Box)	55	69	102	0.387	23.4
TAN002B	Tangerine Stool Black	43	44	74	0.140	5.6
TAN002N	Tangerine Stool Natural	43	44	74	0.140	5.6
TAN003B	Tangerine Stool Black with Back	49	45	91	0.201	6.9
TAN003N	Tangerine Stool Natural with Back	49	45	91	0.201	6.9

Terms & Conditions

Buying

All prices listed are retail excluding tax unless stated
Appropriate trade discounts are applicable to the listed retail prices
Trade discounts do not apply to shipping costs
Payment terms are pro-forma

Warranty

Resident Ltd warrants its products to be free from defects in materials and workmanship for a period of three (3) years from date of delivery.

During this warranty period Resident will repair or replace, at its option, products that are proven to be defective. This warranty does not apply to damages resulting from accident, alteration, tampering, misuse, negligence or abuse. This warranty does not apply to light bulbs, which are not products manufactured by Resident and are supplied by Resident only as an accommodation (please note some lighting fixtures do not ship with light bulbs). The warranty only cover materials and no other costs associated with replacing faulty products.

Disclaimer

All of our products are lovingly hand finished, which can often lead to slight irregularities. Resident reserves the right to make the final judgment on a defect arising from the handmade nature of the process or the characteristics of the material. Resident's warranty does not apply to normal wear and tear, customers' own fabric, effects of extreme temperature or unusual environment conditions. No responsibility will be accepted for misuse of products; neither does the company's responsibility extend to any damage cause by inadequate maintenance or faulty assembly on the part of the purchaser.

Order Changes

Always make sure that the order confirmation corresponds to your order. All requests for changes or cancellations of a confirmed order require approval from a Resident representative. If you have had a change of mind with your purchase you can return the items to us within 14 days of receipt of your goods for a refund, excluding postal charges. This will incur a restocking fee of 10%. Items should be unused, returned in their original packaging and in a fully resalable condition.

Distribution

Resident distributes to the following countries throughout Europe from our distribution hub in London: Austria, Belgium, Croatia, Czech Republic, France, Germany, Hungary, Ireland, Italy, Luxembourg, The Netherlands, Portugal, Poland, Spain, Switzerland

For orders above €2000 shipping is free of charge

For orders less than €2000 shipping is charged at 10% of the total invoice value Any import taxes are to be paid by the receiver

Transport Damages

If there are evident damages to goods and / or packaging upon receipt it must be documented with a written note on the freight bill, with the signature of the driver. Product damages must immediately be reported to either the supplier or directly to Resident in writing. All damages should be documented with photos in order to facilitate the handling of the claim.

All returns must be authorized in writing prior to return

As of October 01st 2018 this price list comes into effect, all previous price lists are no longer valid.

Contact

Resident Showroom
61 Upper Queen Street
Newton Auckland
New Zealand
+64 9 601 9241
www.resident.co.nz

Sales enquiries UK & EU
nina@resident.co.nz

Sales enquiries USA
natalie@resident.co.nz

Sales enquiries Rest of World
sales@resident.co.nz