

ZERO[®]—PRICELIST

EXPORT-NL

Excl VAT

20140507

Eikelenboom
Crugiusweg 111 L
1019 AB Amsterdam
Tel: 020 6918161
Fax: 020 6915411
info@eikelenboom.nl
www.eikelenboom.nl



CONTENT

CEILING	3-15
PENDANTS/SUSPENSION	16-36
WALL	37-44
SHELF	45
TABLE	46-48
FLOOR	48-52
OUTDOOR	53-64

CAP



Finish: Shade in opal PMMA. Base in black painted aluminium. Other colours on request.

Installation: In ceiling or on wall.

Connection: Terminal block 5*4mm².

Design: Joel Karlsson, Krook & Tjäder Design 2013

ART	BESKRIVNING		PRICE/EUR
3305106	CAP wall opal/black	IP54 26-42W/Gx24q HF D350 mm	359,60
3305106HF-F	CAP wall black/opal D350 mm	IP54 26-42W/Gx24q Dim	425,49
3306106	CAP ceiling-wall black D350 mm	IP54 LED 15,3W/1800 lm	457,84
3306106HF-F	CAP ceiling wall black D350 mm	IP54 LED 15,3W/1800 lm Dim	540,75

HF = Dimmable with SwitchDIM, DSI or DALI. 1-10V on request.

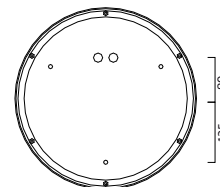
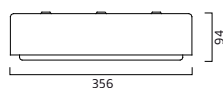

CORD



Finish: Base in white painted metal. Diffuser in matt acrylic. Rubber bands in different colors.

Possible to mix two colors on request.

Installation: Ceiling.

Connection: Terminal block 5x4mm².

Design: Mia Cullin 2012.

ART	DESCRIPTION		PRICE/EUR
82121-XX	CORD ceiling white/XX	IP20 40W/2G13 HF D413 mm	764,91
82121-XXHF-F	CORD ceiling white/XX	IP20 40W/2G13 HFF D413 mm	816,89
82123-XX	CORD ceiling white/XX	IP20 40W/2G13 HF D600 mm	1 032,26
82123-XXHF-F	CORD ceiling white/XX	IP20 40W/2G13 HFF D600 mm	1 084,24
82131-XX	CORD ceiling white/XX	IP20 55W/2G13 HF D413 mm	764,91
82131-XXHF-F	CORD ceiling white/XX	IP20 55W/2G13 HFF D413 mm	816,89
82133-XX	CORD ceiling white/XX	IP20 55W/2G13 HF D600 mm	1 032,26
82133-XXHF-F	CORD ceiling white/XX	IP20 55W/2G13 HFF D600 mm	1 084,24
82141-XX	CORD ceiling HF white/XX	IP20 LED/1800LM/15,3W/3000K	776,72
82141-XXHF-F	CORD ceiling HFF white/XX	IP20 LED/1800LM/15,3W/3000K	865,84
82143-XX	CORD ceiling HF white/XX	IP20 LED/1800LM/15,3W/3000K	962,38
82143-XXHF-F	CORD ceiling HFF white/XX	IP20 LED/1800LM/15,3W/3000K	1 051,50

With motion detector.

82141-XXS	CORD ceiling HF white/	IP20 LED/1800LM/15,3W/3000K	821,00
82141-XXHFFS	CORD ceiling HFF white/	IP20 LED/1800LM/15,3W/3000K	907,58
82143-XXS	CORD ceiling HF white/	IP20 LED/1800LM/15,3W/3000K	1 001,31
82143-XXHFFS	CORD ceiling HFF white/	IP20 LED/1800LM/15,3W/3000K	1 087,83

HF = Dimmable with SwitchDIM, DSI or DALI. 1-10V on request.

XX = -01 white, -06 black, -12 green, -14 yellow, -41 orange.

THIRTY



Finish: Turnable wall- ceiling fixture in painted aluminium. Diffuser in microprisma. Other colours on request.

Installation: In ceiling or on wall.

Connection: Terminal block 5x4mm².

Design: Samuel Wilkinson 2013

ART	DESCRIPTION		PRICE/EUR
8245101	THIRTY wall/ceiling white	IP20 LED HF D245 mm	502,00
8245101HF-F	THIRTY wall/ceiling white	IP20 LED HFF D245 mm	544,36
8245106	THIRTY wall/ceiling black	IP20 LED HF D245 mm	502,00
8245106HF-F	THIRTY wall/ceiling black	IP20 LED HFF D245 mm	544,36
8245114	THIRTY wall/ceiling yellow	IP20 LED 1470LM/13,5W	502,00
8245114HFF	THIRTY wall/ceiling yellow	IP20 LED 1470LM/13,5W Dim	544,36

HF = Dimmable with SwitchDIM, DSI or DALI. 1-10V on request.

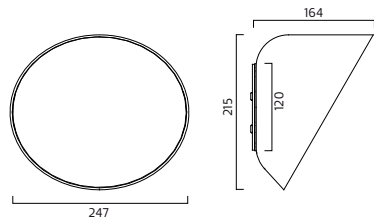

GRID

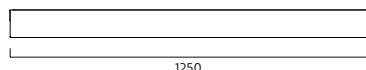
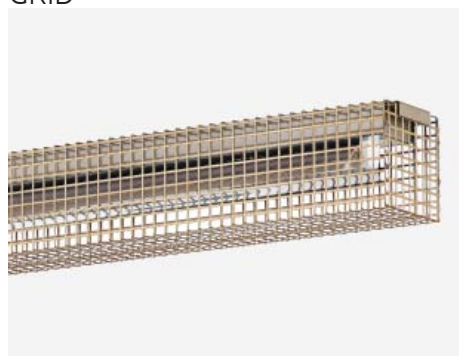

Finish: Perforated metal with square holes or expanded metal. Yellow Ral 1018, orange Ral 2004, clear painted metal or transparent gold varnish. Grid has a raw finish and one can see weldings through the transparent varnish. Reflector available as accessory. LED model has an opal acrylic diffuser.

Installation: Ceiling.

Connection: Terminal block 5x4mm².

Design: Front 2012.

ART	DESCRIPTION		PRICE/EUR
T5 Light tube			
81361XX	GRID ceiling squarehole yellow	IP20 25/28/50/54W T5 HF L1250	621,73
81361XXHF-F	GRID ceiling squarehole yellow	IP20 25/28/50/54W T5 HFF L1250	621,73
81371XX	GRID ceiling expanded yellow	IP20 25/28/50/54W T5 HF L1250	603,62
81371XXHF-F	GRID ceiling expanded yellow	IP20 25/28/50/54W T5 HFF L1250	678,17
LED			
81361XX	GRID ceiling squarehole yellow	IP20 LED 2600LM/22W L1250	844,12
81361XXHF-F	GRID ceiling squarehole yellow	IP20 LED 2600LM/22W L1250	956,59
81371XX	GRID ceiling expanded yellow	IP20 LED 2600LM/22W L1250	844,12
81371XXHF-F	GRID ceiling expanded yellow	IP20 LED 2600LM/22W L1250	956,59
HFF = Dimmable with SwitchDIM, DSI or DALI. 1-10V on request.			
XX = -14 Yellow, -41 Orange, -76 Metal, -77 Gold			
ACCESSORY - Only for T5 model.			
98130-1-82	Reflektor		195,70

PISTILL

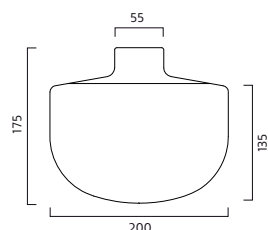

Finish: Base in painted aluminium. Matt opal UV-stabile polyethene. Incl. lightsource.

Installation: Ceiling or wall.

Connection: Terminal block 3x4mm².

Design: Jens Fager 2012.

ART	DESCRIPTION		PRICE/EUR
8090101	PISTILL wall/ceiling white	IP55 10-13W/Gx24q HF D200 mm	340,13
8090141	PISTILL wall/ceiling orange	IP55 10-13W/Gx24q HF D200 mm	340,13
8090195	PISTILL wall/ceiling grey	IP55 10-13W/Gx24q HF D200 mm	340,13
8091101	PISTILL wall/ceiling white	IP55 7W/E27/Mini Twist D200 mm	310,10
8091141	PISTILL wall/ceiling orange	IP55 7W/E27/Mini Twist D200 mm	310,10
8091195	PISTILL wall/ceiling grey	IP55 7W/E27/Mini Twist D200 mm	310,10
8092101	PISTILL wall/ceiling white	IP55 LED/4 W D200 mm	323,57
8092141	PISTILL wall/ceiling orange	IP55 LED/4 W D200 mm	323,57
8092195	PISTILL wall/ceiling grey	IP55 LED/4 W D200 mm	323,57



XM

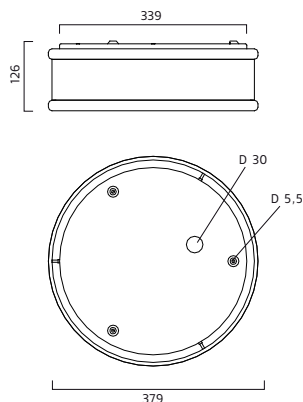

Finish: Base in white painted aluminium. Matt opal glass and shade in expanded metal, white, black or copper.
Installation: Ceiling or wall.
Connection: Terminal block 5x4mm².
Design: Joel Karlsson, Krook & Tjäder Design 2011.

ART	DESCRIPTION		PRICE/EUR
8080101	XM wall-ceiling lamp white	IP20 26-42W/Gx24q HF D400 mm	591,06
8080101HF-F	XM wall-ceiling lamp white	IP20 42W/Gx24q HFF D400 mm	642,52
8080106	XM wall-ceiling lamp black	IP20 26-42W/Gx24q HF D400 mm	591,06
8080106HF-F	XM wall-ceiling lamp black	IP20 42W/Gx24q HFF D400 mm	642,52
8081101	XM Ceiling-wall HF white/white	IP20 LED/1800Lm/15,3W/3000K	660,48
8081101HF-F	XM Ceiling-wall HFF white/whit	IP20 LED/1800Lm/15,3W/3000K	746,96
8081106	XM Ceiling-wall HF white/black	IP20 LED/1800Lm/15,3W/3000K	660,48
8081106HF-F	XM Ceiling-wall HFF white/blac	IP20 LED/1800Lm/15,3W/3000K	746,96
With motion detector			
8081101S	XM Ceiling-wall HF white	IP20 LED/1800Lm/15,3W/3000K	727,43
8081101HFFS	XM Ceiling-wall HFF white	IP20 LED/1800Lm/15,3W/3000K	813,91
8081106S	XM Ceiling-wall HF black	IP20 LED/1800Lm/15,3W/3000K	727,43
8081106HFFS	XM Ceiling-wall HFF black	IP20 LED/1800Lm/15,3W/3000K	813,91
	XM shade in Copper		on request

HFF = Dimmable with SwitchDIM, DSI or DALI. 1-10V on request.

WOOD

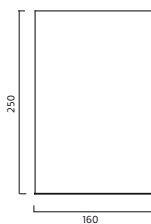

Finish: Oiled oak veneer natural or black stained. Matt acrylic diffuser. When metal halide clear glass. Available in other wood finishes and stains on request.
Installation: Ceiling.
Connection: Terminal block 5x4mm². Two entry holes.
Design: Fredrik Mattson 2010.

ART	DESCRIPTION		PRICE/EUR
8000132	WOOD celing fixture oiled oak	IP20 26-32W/Gx24q HF H160	483,90
8000132HF-F	WOOD celing fixture oiled oak	IP20 32W/Gx24q HFF H160 mm	536,89
8000136	WOOD celing fixture black oak	IP20 26-32W/Gx24q HF H160 mm	483,90
8000136HF-F	WOOD celing fixture black oak	IP20 32W/Gx24q HFF H160 mm	536,89
8001132	WOOD celing fixture oiled oak	IP20 35W/G12 HF H160 mm	597,69
8001136	WOOD celing fixture black oak	IP20 35W/G12 HF H160 mm	597,69
8002132	WOOD celing fixture oiled oak	LED2000Lm/830 H160 mm	1 350,94
8002136	WOOD celing fixture black oak	LED2000Lm/830 H160 mm	1 350,94

HFF = Dimmable with SwitchDIM, DSI or DALI. 1-10V on request.

WOOD

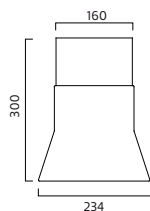

Finish: Oiled or black stained oak veneer and matt opal glass. Available in other wood finishes and stains on request.
Installation: Ceiling.
Connection: Terminal block 5x4mm². Two entry holes.
Design: Fredrik Mattson 2010.

ART	DESCRIPTION		PRICE/EUR
8040132	WOOD ceiling fixture oiled oak	IP20 26-32W/Gx24q HF H300	531,95
8040132HF-F	WOOD ceiling fixture oiled oak	IP20 32W/Gx24q HFF H300 D234	584,96
8040136	WOOD ceiling fixture black oak	IP 20 26-32W/Gx24q HF H300	531,95
8040136HF-F	WOOD ceiling fixture black oak	IP20 32W/Gx24q HFF H300 D234	584,96
8041132	WOOD ceiling fixture oiled oak	IP20 LED/2000Lm/830 H300 D234	1 062,51
8041136	WOOD ceiling fixture black oak	IP20 LED/2000Lm/830 H300 D234	1 062,51

HFF = Dimmable with SwitchDIM, DSI or DALI. 1-10V on request.

WOOD



Finish: Oiled oak veneer natural or black stained. Matt acrylic diffuser. When metal halide clear glass. Available in other wood finishes and stains on request.

Installation: Ceiling, wall or with 3-phase adapter.

Connection: 3 phase track or terminal block 5x4mm², two entry holes.

Design: Fredrik Mattson 2010.

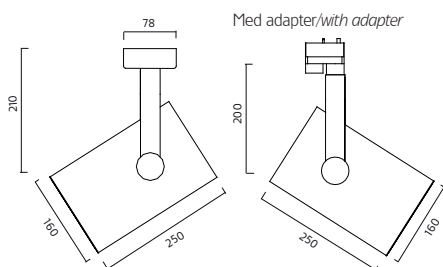

ART	DESCRIPTION	PRICE/EUR
CEILING		
8010132	WOOD ceiling fixture oiled oak IP20 26-32W/Gx24q HF H250 D160	606,35
8010132HF-F	WOOD ceiling fixture oiled oak IP20 32W/Gx24q HFF H250 D160	663,62
8010136	WOOD ceiling fixture black oak IP20 26-32W/Gx24q HF H250 D160	606,35
8010136HF-F	WOOD ceiling fixture black oak IP20 32W/Gx24q HFF H250 D160	663,62
8011132	WOOD ceiling fixture oiled oak IP20 35W/G12 H250 D160	720,88
8011136	WOOD ceiling fixture black oak IP20 35W/G12 H250 D160	720,88
8012132	WOOD ceiling fixture oiled oak IP20 LED/2000Lm/830 H250 D160	991,86
8012136	WOOD ceiling fixture black oak IP20 LED/2000Lm/830 H250 D160	991,86
WITH 3-PHASE ADAPTER		
8014132	WOOD ceiling fixture oiled oak IP20 26-32W/Gx24q + adapter	663,62
8014136	WOOD ceiling fixture black oak IP20 26-32W/Gx24q + adapter	663,62
8015132	WOOD ceiling fixture oiled oak IP20 35W/G12 + adapter	778,13
8015136	WOOD ceiling fixture black oak IP20 35W/G12 + adapter	778,13
8016132	WOOD ceiling fixture oiled oak LED/2000Lm/830 + adapter	1 194,16
8016136	WOOD ceiling fixture black oak LED/2000Lm/830 + adapter	1 194,16

HFF = Dimmable with SwitchDIM, DSI or DALI. 1-10V on request.

UMBRELLA

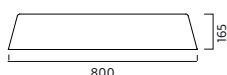

Finish: Opal acrylic and painted acrylic. Pure white Ral 9010, Graphite black 9011 or Opal green Ral 6026. Other colors on request

Installation: Ceiling-installation.

Connection: Terminal block 5x4mm² Two entry holes.

Design: Monica Förster 2009.

ART	DESCRIPTION	PRICE/EUR
7890301	UMBRELLA ceiling lamp white IP20 4x36W/2G11 HF D800	915,83
7890301HF-F	UMBRELLA ceiling lamp white IP20 4x36W/2G11 HFF D800	1 204,04
7890306	UMBRELLA ceiling lamp black IP20 4x36W/2G11 HF D800	915,83
7890306HF-F	UMBRELLA ceiling lamp black IP20 4x36W/2G11 HFF D800	1 204,04
7890312	UMBRELLA ceiling lamp green IP20 4x36W/2G11 HF D800	915,83
7890312HF-F	UMBRELLA ceiling lamp green IP20 4x36W/2G11 HFF D800	1 204,04

HFF = Dimmable with SwitchDIM, DSI or DALI. 1-10V on request.

BEAM

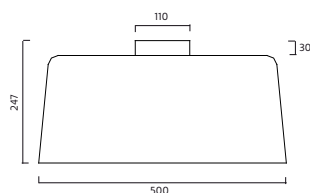

Finish: Painted aluminum and metal. For compact fluorescent 26, 32 or 42W.

Installation: Ceiling.

Connection: Terminal block 5x4 mm². Two entry holes.

Design: Johan Carpner 2010.

ART	DESCRIPTION	PRICE/EUR
8153101	BEAM ceiling fixture white IP20 26-42W/Gx24q HF D500	813,67
8153101HF-F	BEAM ceiling fixture white IP20 42W/Gx24q HFF D500	874,15
8153106	BEAM ceiling fixture black IP20 26-42W/Gx24q HF D500	813,67
8153106HF-F	BEAM ceiling fixture black IP20 42W/Gx24q HFF D500	874,15
8153107	BEAM ceiling fixture red IP20 26-42W/Gx24q HF D500	813,67
8153107HF-F	BEAM ceiling fixture red IP20 42W/Gx24q HFF D500	874,15

HFF = Dimmable with SwitchDIM, DSI or DALI. 1-10V on request.



STITCH

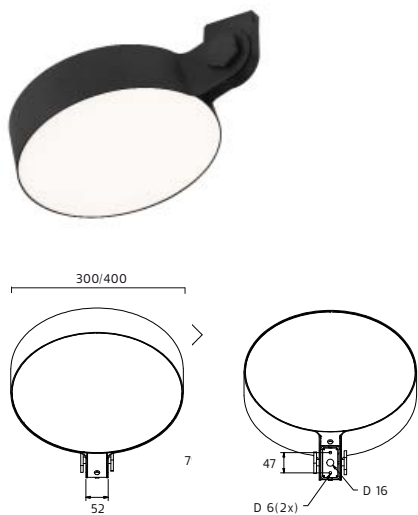

Vätt-/takbricka

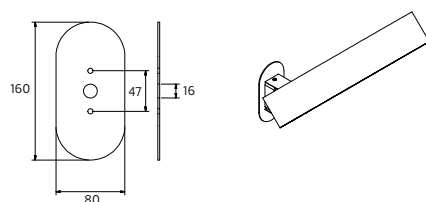

Finish: Painted metal (Red Ral 3020) and matt opal acrylic. For T5 circular tube. Tools are required to adjust the angle. State requested angle when ordering. Available in angle 0°, 30°, 60° och 90°.

Installation: On ceiling or on wall. Wall/ceiling washer for installation on porous material available as assessor.

Connection: Terminal block 5x4mm².

Design: Mattias Ståhlbom 2010.

ART	DESCRIPTION		PRICE/EUR
8070101	STITCH wall-ceiling lamp white	IP20 22W/2Gx1 3 HF D300 mm	436,24
8070101HF-F	STITCH wall-ceiling lamp white	IP20 22W/2Gx1 3 HFF D300 mm	495,18
8070106	STITCH wall-ceiling lamp black	IP20 22W/2Gx1 3 HF D300 mm	436,24
8070106HF-F	STITCH wall-ceiling lamp black	IP20 22W/2Gx1 3 HFF D300 mm	495,18
8070107	STITCH wall-ceiling lamp red	IP20 22W/2Gx1 3 HF D300 mm	436,24
8070107HF-F	STITCH wall-ceiling lamp red	IP20 22W/2Gx1 3 HFF D300 mm	495,18
8070301	STITCH wall-ceiling lamp white	IP20 40W/2Gx1 3 HF D400 mm	513,71
8070301HF-F	STITCH wall-ceiling lamp white	IP20 40W/2Gx1 3 HFF D400 mm	572,65
8070306	STITCH wall-ceiling lamp black	IP20 40W/2Gx1 3 HF D400 mm	513,71
8070306HF-F	STITCH wall-ceiling lamp black	IP20 40W/2Gx1 3 HFF D400 mm	572,65
8070307	STITCH wall-ceiling lamp red	IP20 40W/2Gx1 3 HF D400 mm	513,71
8070307HF-F	STITCH wall-ceiling lamp red	IP20 40W/2Gx1 3 HFF D400 mm	572,65

ASSESSORY	FINISH	PRICE/EUR
98070101	STITCH wall washer white 160x80	10,45
98070106	STITCH wall washer black 160x80	10,45
98070107	STITCH wall washer red 160x80	10,45

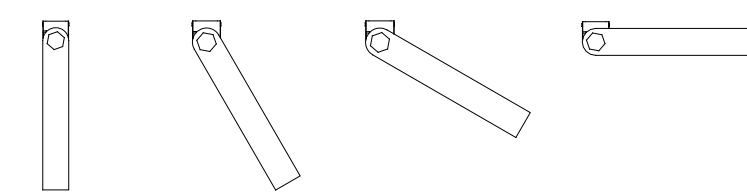

PXL

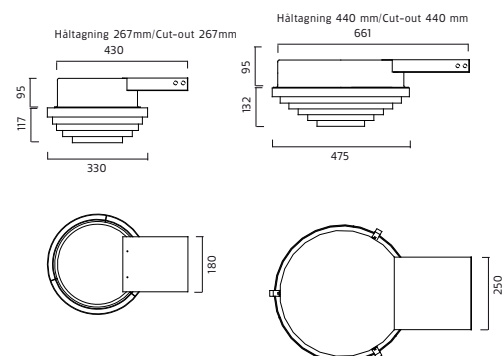

Finish: Painted aluminum and metal. Diffuser in matt acrylic. With reflector. **Installation:** Partly recessed. Support-frame for plaster ceilings available as accessory.

Connection: Terminal block 5x4mm². Two entry holes.

Design: Fredrik Mattson 2010.

ART	DESCRIPTION		PRICE/EUR
7970101	PXL ceiling fixture white	IP20 26-42W/Gx24q HF D330 mm	662,35
7970101HF-F	PXL ceiling fixture white	IP20 42W/Gx24q HFF D330 mm	715,36
7970190	PXL ceiling fixture multi	IP20 26-42W/Gx24q HF D330 mm	662,35
7970190HF-F	PXL ceiling fixture multi	IP20 42W/Gx24q HFF D330 mm	715,36
7970301	PXL ceiling fixture white	IP20 26-42W/Gx24q HF D475 mm	851,59
7970301HF-F	PXL ceiling fixture white	IP20 42W/Gx24q HFF D475 mm	904,59
7970390	PXL ceiling fixture multi	IP20 26-42W/Gx24q HF D475 mm	851,59
7970390HF-F	PXL ceiling fixture multi	IP20 42W/Gx24q HFF D475 mm	904,59
7972101	PXL ceiling fixtures white	IP20 LED/2000Lm/830 D330 mm	1 251,43
7972190	PXL ceiling fixtures multi	IP20 LED/2000Lm/830 D330 mm	1 251,43
7972301	PXL ceiling fixtures white	IP20 LED/2000Lm/830 D475 mm	1 440,06
7972390	PXL ceiling fixtures multi	IP20 LED/2000Lm/830 D475 mm	1 440,06

HFF = Dimmable with SwitchDIM, DSI or DALI. 1-10V on request.

PXL

Finish: Painted aluminum and metal. Diffuser in matt acrylic. T5 circular tube.
Installation: Partly recessed. Support-frame for plaster ceilings available as accessory.
Connection: Terminal block 5x4mm². Two entry holes.
Design: Fredrik Mattson.

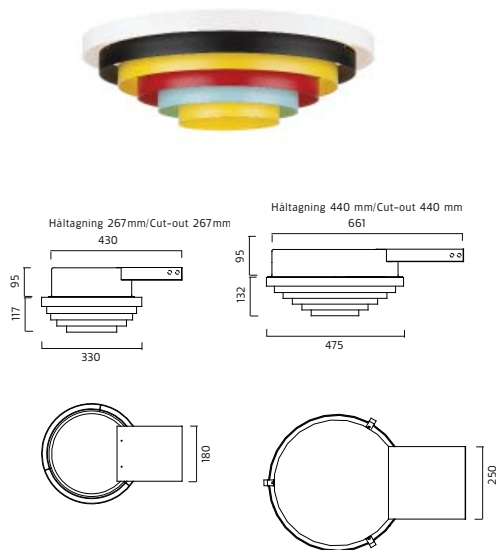

ART	DESCRIPTION		PRICE/EUR
7971101	PXL ceiling fixture white	IP20 22W/2Gx13 HF D330 mm	662,35
7971101hf-f	PXL ceiling fixture white	IP20 22W/2Gx13 HFF D330 mm	715,36
7971190	PXL ceiling fixture multi	IP20 22W/2Gx13 HF D330 mm	662,35
7971190hf-f	PXL ceiling fixture multi	IP20 22W/2Gx13 HFF D330 mm	715,36
7971301	PXL ceiling fixture white	IP20 40W/2Gx13 HF D475 mm	851,59
7971301hf-f	PXL ceiling fixture white	IP20 40W/2Gx13 HFF D475 mm	904,59
7971390	PXL ceiling fixture multi	IP20 40W/2Gx13 HF D475 mm	851,59
7971390hf-f	PXL ceiling fixture multi	IP20 40W/2Gx13 HFF D475 mm	904,59
7971401	PXL ceiling fixture white	IP20 55W/2Gx13 HF D475 mm	851,59
7971401hf-f	PXL ceiling fixture white	IP20 55W/2Gx13 HFF D475 mm	904,59
7971490	PXL ceiling fixture multi	IP20 55W/2Gx13 HF D475 mm	851,59
7971490hf-f	PXL ceiling fixture multi	IP20 55W/2Gx13 HFF D475 mm	904,59

HFF = Dimmable with SwitchDIM, DSI or DALI. 1-10V on request.

FOTO

Finish: Ceiling fixture with adjustable spotlight. Painted steel and die-casted aluminium. Metal halide has light beam 24 degrees.
Connection: Fixed installation, terminal block 2x2,5mm² or with adapter for 3-circuit track installation.
Design: Thomas Bernstrand, Mattias Ståhlbom 2007.

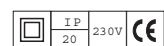
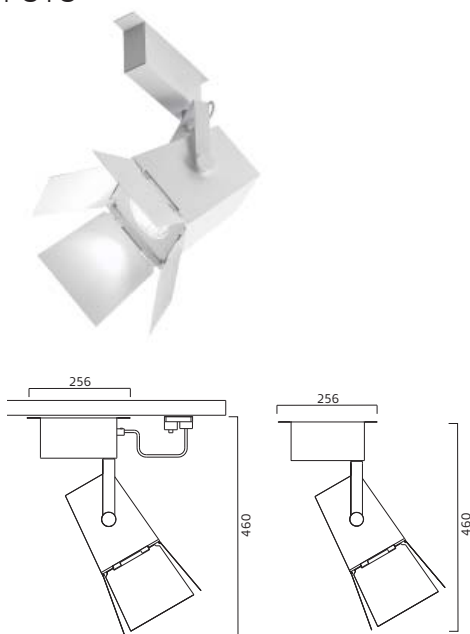

WITH 3-PHASE ADAPTER			PRICE/EUR
ART	DESCRIPTION		
7760101	FOTO ceiling spot large white	35W/G12 med 3-fas adapter	720,25
7760106	FOTO ceiling spot large black	35W/G12 with 3-fas adapter	720,25
7761101	FOTO ceiling spot large white	70W/G12 with 3-fas adapter	720,25
7761106	FOTO ceiling spot large black	70W/G12 with 3-fas adapter	720,25
7766101	FOTO ceiling/spot large white	26W/Gx24q with 3-fas adapter	661,08
7766106	FOTO ceiling/spot large black	26W/Gx24q with 3-fas adapter	661,08

CEILING			PRICE/EUR
ART	DESCRIPTION		
7763101	FOTO ceilinglamp white	IP20 35W/G12/metalhalide HF	662,54
7763106	FOTO ceilinglamp black	IP20 35W/G12/metalhalide HF	662,54
7764101	FOTO ceilinglamp white	IP20 70W/G12/metalhalide HF	662,54
7764106	FOTO ceilinglamp black	IP20 70W/G12/metalhalide HF	662,54
7765101	FOTO ceilinglamp white	26W/Gx24q fixed installation	603,68
7765106	FOTO ceiling/spot large black	26W/Gx24q fixed installation	603,68

FOTO

Finish: Ceiling fixture with adjustable spotlight. Painted steel and die-casted aluminium.
Connection: Adapter with built in transformer for 3-circuit track installation.
Design: Thomas Bernstrand, Mattias Ståhlbom.

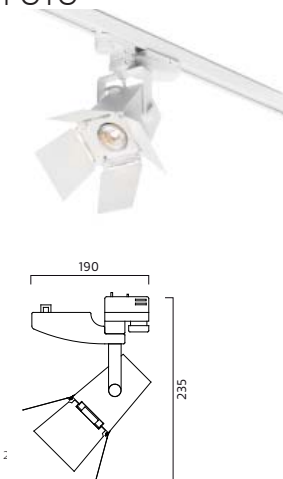

ART	DESCRIPTION		PRICE/EUR
7768101	FOTO spot ceiling white	50W/GU5,3 incl 3-adapter	371,95
7768106	FOTO spot ceiling black	50W/GU5,3 incl 3-adapter	371,95
7768107	FOTO spot ceiling red	50W/GU5,3 incl 3-adapter	371,95
7768108	FOTO spot ceiling blue	50W/GU5,3 incl 3-adapter	371,95
7768114	FOTO spot ceiling yellow	50W/GU5,3 incl 3-adapter	371,95
7768141	FOTO spot ceiling orange	50W/GU5,3 incl 3-adapter	371,95

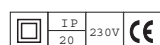

FOTO

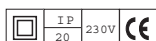
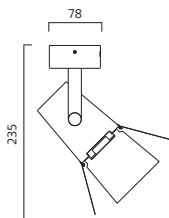

Finish: Ceiling fixture with adjustable spotlight. Painted steel and die-casted aluminium.

Connection: Fixed installation, terminal block 2x2, 5mm² or with adapter for 3-circuit track installation.

Design: Thomas Bernstrand, Mattias Ståhlbom.

ART	DESCRIPTION		PRICE/EUR
7655101	FOTO spot wall/ceiling white	35W/GU10 fixed installation	325,33
7655106	FOTO spot wall/ceiling black	35W/GU10 fixed installation	325,33
7655107	FOTO spot wall/ceiling red	35W/GU10 fixed installation	325,33
7655108	FOTO spot wall/ceiling blue	35W/GU10 fixed installation	325,33
7655114	FOTO spot wall/ceiling yellow	35W/GU10 fixed installation	325,33
7655141	FOTO spot wall/ceiling orange	35W/GU10 fixed installation	325,33
7755101	FOTO spot wall/ceiling white	20W/GU5,3 12V fix installation	388,73
7755106	FOTO spot wall/ceiling black	20W/GU5,3 12V fix installation	388,73
7755107	FOTO spot wall/ceiling red	20W/GU5,3 12V fix installation	388,73
7755108	FOTO spot wall/ceiling blue	20W/GU5,3 12V fix installation	388,73
7755114	FOTO spot wall/ceiling yellow	20W/GU5,3 12V fix installation	388,73
7755141	FOTO spot wall/ceiling orange	20W/GU5,3 12V fix installation	388,73

ALLRIGHT

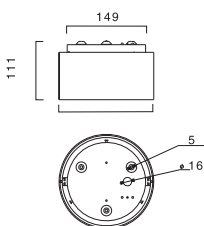
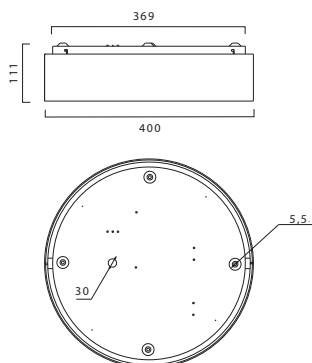

Finish: Anodized aluminium, natural, bronze or dark grey painted and white painted steel. Diffuser in prismatic acrylic.

Installation: Ceiling-installation.

Connection: Terminal block. D108 mm 3x4mm². D400 mm 5x4mm², two entry holes.

Design: Per Sundstedt.

ART	DESCRIPTION		PRICE/EUR
7407338	ALLRIGHT ceiling D400 HF alu	IP20 LED/1800LM/15,3W/3000K	510,81
7407338HF-F	ALLRIGHT ceiling D400 HFF alu	IP20 LED/1800LM/15,3W/3000K	599,92
7407397	ALLRIGHT ceiling D400 bronze	IP20 LED/1800LM/15,3W/3000K	539,03
7407397HF-F	ALLRIGHT ceiling D400 bronze	IP20 LED/1800LM/15,3W/3000K	628,15
7407398	ALLRIGHT ceiling D400 HF grey	IP20 LED/1800LM/15,3W/3000K	539,03
7407398HF-F	ALLRIGHT ceiling D400 HFF grey	IP20 LED/1800LM/15,3W/3000K	628,15
7408338	ALLRIGHT ceiling fixture alu	IP20 40W/2Gx13 HF D400 mm	541,36
7408338HF-F	ALLRIGHT ceiling fixture alu	IP20 40W/2Gx13 HF-F D400 mm	588,33
7408397	ALLRIGHT ceiling bronze	IP20 40W/2Gx13 HF D400 mm	569,58
7408397HF-F	ALLRIGHT ceiling bronze	IP20 40W/2Gx13 HFF D400 mm	616,54
7408398	ALLRIGHT ceiling fixtures grey	IP20 40W/2Gx13 HF D400 mm	569,58
7408398HF-F	ALLRIGHT ceiling fixtures grey	IP20 40W/2Gx13 HFF D400 mm	616,54
7409338	ALLRIGHT ceiling fixture alu	IP20 55W/2Gx13 HF D400 mm	541,36
7409338HF-F	ALLRIGHT ceiling fixture alu	IP20 55W/2Gx13 HF-F D400 mm	588,33
7409397	ALLRIGHT ceiling bronze	IP20 55W/2Gx13 HF D400 mm	569,58
7409397HF-F	ALLRIGHT ceiling bronze	IP20 55W/2Gx13 HFF D400 mm	616,54
7409398	ALLRIGHT ceiling fixtures grey	IP20 55W/2Gx13 HF D400 mm	569,58
7409398HF-F	ALLRIGHT ceiling fixtures grey	IP20 55W/2Gx13 HFF D400 mm	616,54

With motion detector

7407338S	ALLRIGHT ceiling D400 HF grey	IP20 LED/1800LM/15,3W/3000K	579,77
7407338HFFS	ALLRIGHT ceiling D400 HFF grey	IP20 LED/1800LM/15,3W/3000K	668,88
7407397S	ALLRIGHT ceiling D400 bronze	IP20 LED/1800LM/15,3W/3000K	607,99
7407397HFFS	ALLRIGHT ceiling D400 bronze	IP20 LED/1800LM/15,3W/3000K	697,10
7407398S	ALLRIGHT ceiling D400 HF grey	IP20 LED/1800LM/15,3W/3000K	607,99
7407398HFFS	ALLRIGHT ceiling D400 HFF grey	IP20 LED/1800LM/15,3W/3000K	697,10

HFF = Dimmable with SwitchDIM, DSI or DALI. 1-10V on request.

STREAM

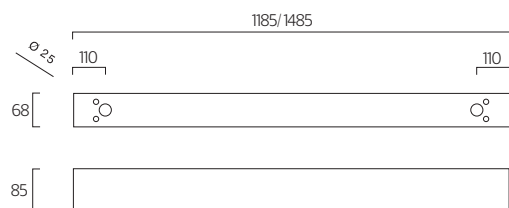

Finish: White- or grey painted steel and matt acrylic. Single- or double-asymmetrical diffuser available as accessory.

Installation: Ceiling-installation.

Connection: Snap-in terminal block 5x4mm². Two cable entries.

Design: R. Aosta & Anders Broing.

ART	DESCRIPTION		PRICE/EUR
7523501	STREAM ceiling L1185 white	IP20 28W/T5 HF	406,01
7523501HF-F	STREAM ceiling L1185 white	IP20 28W/T5 HFF	494,19
7523510	STREAM ceiling fix. L1185 grey	IP20 28W/T5 HF	406,01
7523510HF-F	STREAM ceiling fix. L1185 grey	IP20 28W/T5 HFF	494,19
7523701	STREAM ceiling L1485 white	IP20 35W/T5 HF	454,23
7523701HF-F	STREAM ceiling L1485 white	IP20 35W/T5 HFF	517,00
7523710	STREAM ceiling fix. L1485 grey	IP20 35W/T5 HF	454,23
7523710hf-f	STREAM ceiling fix. L1485 grey	IP20 35W/T5 HFF	517,00

HFF = Dimmable with SwitchDIM, DSI or DALI. 1-10V on request.



STREAM

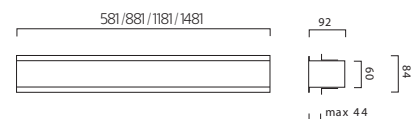
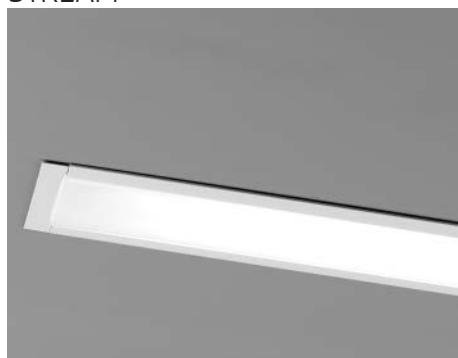

Finish: White painted steel. Diffuser in matt acrylic. Single- or double-asymmetrical diffuser available as accessory.

Installation: Recess installation.

Connection: Snap-in terminal block 5x4mm². Two cable entries.

Design: R. Aosta & Anders Broing.

ART	DESCRIPTION		PRICE/EUR
7520101	STREAM ceiling fix. recess. L5	IP20 14W/T5 HF	330,62
7520101HF-F	STREAM ceiling fix. recess. L581	IP20 14W/T5 HFF	396,93
7520301	STREAM ceiling fix. recess. L881	IP20 21W/T5 HF	364,23
7520301HF-F	STREAM ceiling fix. recess. L881	IP20 21W/T5 HFF	429,55
7520501	STREAM ceiling fix. rec. L1181	IP20 28W/T5 HF	406,01
7520501HF-F	STREAM ceiling fix. rec. L1181	IP20 28W/T5 HFF	470,03
7520701	STREAM ceiling fix. rec. L1481	IP20 35W/T5 HF	429,53
7520701HF-F	STREAM ceiling fix. rec. L1481	IP20 35W/T5 HFF	493,02

HFF = Dimmable with SwitchDIM, DSI or DALI. 1-10V on request.

ACCESSORIES

97520101	STREAM straight connector		12,36
97521101	STREAM end panel		12,36
97522101	STREAM end panel	for T-profile ceiling	18,54



MIMMI

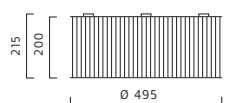

Finish: Grey painted steel. White pleated shade in polyester. Opal acrylic diffuser.

Installation: Ceiling-installation.

Connection: Snap-in terminal block 5x4mm². Two cable entries.

Design: pelikan copenhagen.

ART	DESCRIPTION		PRICE/EUR
4471135	MIMMI ceiling fixture	IP20 4x75W/E27 D495 H200	531,03
4472135	MIMMI ceiling fixture D495H200	IP20 4x26-32W/Gx24q-3 HF	672,06
4472135HF-F	MIMMI ceiling fixture D495 H20	IP20 4x32W/Gx24q-3 HFF	844,55
4473135HF-F	MIMMI ceiling fixture D495 H20	IP20 4x42W/Gx24q-3 HFF	844,55
4474135	MIMMI ceiling fixture D495 H90	IP20 4x26-42W/Gx24q-3 HF	653,50
4474135HF-F	MIMMI ceiling fixture D495 H90	IP20 4x32W/Gx24q-3 HFF	826,48

HFF = Dimmable with SwitchDIM, DSI or DALI. 1-10V on request.



ARCAD

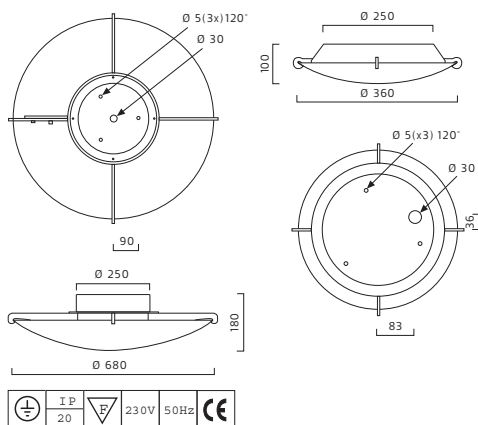

Finish: Dark-grey painted steel. Shade in matt opal glass or matt acrylic.

Installation: Ceiling-installation.

Connection: Snap-in terminal block 5x4mm². Two cable entries. Knockout for external mains cable.

Design: Per Sundstedt.

ART	DESCRIPTION		PRICE/EUR
4064121	ARCAD wall D360 HF glass white	IP20 LED/1800LM/15,3W/3000K	374,92
4064121HF-F	ARCAD wall D360 HFF glass	IP20 LED/1800LM/15,3W/3000K	455,67
4064121HFFS	ARCAD wall D360 HFF glass	IP20 LED/1800LM/15,3W/3000K	524,89
4064121S	ARCAD wall D360 HF glass white	IP20 LED/1800LM/15,3W/3000K	444,14
4065121HF	ARCAD ceiling fixture glass	IP20 22W/T5 HF D360 mm	386,92
4065121HF-F	ARCAD ceiling fixture glass	IP20 22W/T5 HFF D360 mm	478,82
4065127HF	ARCAD ceiling fixture acrylic	IP20 22W/T5 HF D360 mm	326,04
4065127HF-F	ARCAD ceiling fixture acrylic	IP20 22W/T5 HFF D360 mm	417,94
4082321HF	ARCAD ceiling fixture glass	IP20 4x18W/Gx24q-2 HF D680 mm	1 161,49
4082321HF-F	ARCAD ceiling fixture glass	IP20 4x18W/Gx24q-2 HFF D680 mm	1 346,42
4082327HF	ARCAD ceiling fixture acrylic	IP20 4x18W/Gx24q-2 HF D680 mm	1 014,02
4082327HF-F	ARCAD ceiling fixture acrylic	IP20 4x18W/Gx24q-2 HFF D680 mm	1 200,22
4083321HF	ARCAD ceiling fixture glass	IP20 4x26-42W/Gx24q-3 HF D680	1 176,39
4083321HF-F	ARCAD ceiling fixture glass	IP20 4x32W/Gx24q-3 HFF D680 mm	1 361,17
4083327HF	ARCAD ceiling fixture acrylic	IP20 4x26-42W/Gx24q-3 HF D680	1 059,61
4083327HF-F	ARCAD ceiling fixture acrylic	IP20 4x32W/Gx24q-3 HFF	1 211,61
4084321	ARCAD ceiling fixture glass	IP20 4x75W/E27 D680 mm	884,71
4084327	ARCAD ceiling fixture acrylic	IP20 4x75W/E27 D680 mm	748,89
4086321HF-F	ARCAD ceiling fixture glass	IP20 4x42W/Gx24q-4 HFF D680 mm	1 361,17
4086327HF-F	ARCAD ceiling fixture acrylic	IP20 4x42W/Gx24q-3 HFF D680 mm	1 211,61

HFF = Dimmable with SwitchDIM, DSI or DALI. 1-10V on request.

BOWI

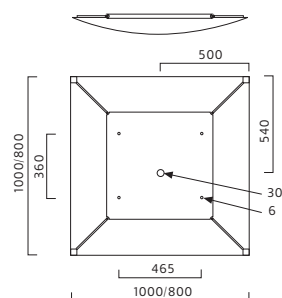

Finish: White painted steel. Fire protected fabric Kvadrat Palet 2. Washable 60°. Art no. 3132-1-39 has perforated fabric.

Installation: Ceiling-installation.

Connection: Snap-in terminal block 5x4mm². Two cable entries.

Design: Per Sundstedt.

ART	DESCRIPTION		PRICE/EUR
3130139HF	BOWI Ceiling fixture closed	IP20 2x36W/2G11 HF B/B 1000 mm	550,13
3130139HF-F	BOWI Ceiling fixture closed	IP20 2x36W/2G11 HFF B/B 1000mm	635,67
3131139HF	BOWI Ceiling fixture closed	IP20 4x36W/2G11 HF B/B 1000 mm	669,59
3131139HF-F	BOWI Ceiling fixture closed	IP20 4x36W/2G11 HFF B/B 1000mm	844,17
3132139	BOWI Ceiling perforated	IP20 4x40W/E14 B/B 800 mm	433,28

HFF = Dimmable with SwitchDIM, DSI or DALI. 1-10V on request.

ACCESSORIES

93130101	BOWI Support L600 mm		39,86
93130301	BOWI support L1200mm		47,88



595

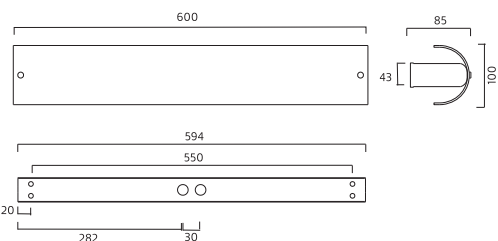

Finish: Zincgrey painted steel. Shade in matt opal glass or matt acrylic.

Installation: Wall or ceiling installation. Spacer for surface-run mains available as accessory.

Connection: Snap-in terminal block 3x4mm². Two entry holes.

Design: Inger Thede.

ART	DESCRIPTION		PRICE/EUR
7630121	595 Cei/wall fixture glass	IP20 14W/T5 HF L600 mm	222,63
7630121HF-F	595 Cei/wall fixture glass	IP20 14W/T5 HFF L600 mm	298,33
7630127	595 Cei/wall fixture acrylic	IP20 14W/T5 HF L600 mm	181,18
7630127HF-F	595 Cei/wall fixture acrylic	IP20 14W/T5 HFF L600 mm	274,04

HFF = Dimmable with SwitchDIM, DSI or DALI. 1-10V on request.

ACCESSORIES

97630121	595 Spacer f. surface-run main		35,44
----------	--------------------------------	--	-------



595



Finish: Zincgrey painted steel. Shade in matt opal acrylic.

Installation: Wall or ceiling installation. Spacer for surface-run mains available as accessory.

Connection: Snap-in terminal block 3x4mm². Two entry holes.

Design: Inger Thede.

ART	DESCRIPTION		PRICE/EUR
7637127	595 Ceiling/wall acrylic	IP44 14W/T5 HF L600 mm	199,93
7639127	595 Ceiling/wall acrylic	IP44 LED L600 mm	341,25
7639127HFF	595 Ceiling/wall acrylic	IP44 LED L600 mm	389,03
ACCESSORIES			
97630121	595 Spacer f. surface-run main		35,44

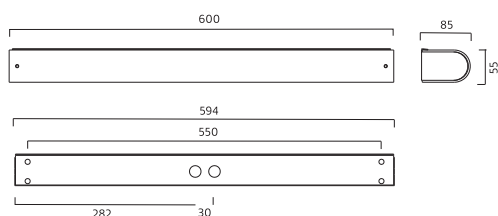

SPJUTET



Finish: White and chromed steel.

Installation: Ceiling, 3-phase track or wall.

Connection: Fixture incl. el-transformer. Terminal block 2x2,5mm².

Design: Stig Ahlström, Claes Koch.

ART	DESCRIPTION		PRICE/EUR
5020101	SPJUTET ceiling-/wallfitting	IP20 50W L145 incl transformer	145,04
5020301	SPJUTET ceiling-/wallfitting	IP20 50W L145 incl transformer	181,30
5600182	SPJUTET L200 mm chrome	IP20 20-50W/Gu5,3	93,64
5600382	SPJUTET L500 mm chrome	IP20 20-50W/Gu5,3	100,33
5600582	SPJUTET L750 mm chrome	IP20 20-50W/Gu5,3	103,36
5600782	SPJUTET L1000 mm chrome	IP20 20-50W/Gu5,3	114,61
5610182	SPJUTET L200 mm chrome	IP20 20-50W/Gu5,3 with adaptor	143,87
5610382	SPJUTET L500 mm chrome	IP20 20-50W/Gu5,3 with adapter	173,11
5610582	SPJUTET L750 mm chrome	IP20 20-50W/Gu5,3 with adapter	175,45
5610782	SPJUTET L1000 mm chrome	IP20 20-50W/Gu5,3 with adapter	184,80

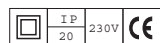

5020-1-01

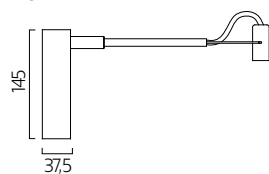

5020-3-01

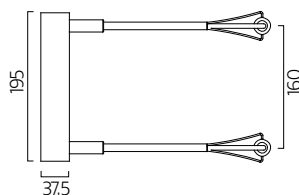

5600-

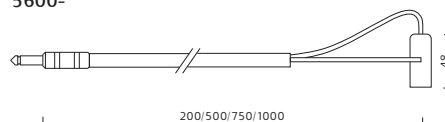

PS 5

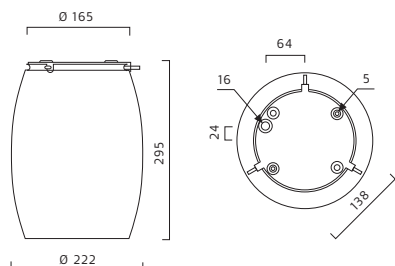

Finish: Chromed steel. Shade in matt opal glass. Aluminium reflector as accessory.
Installation: Ceiling-installation.
Connection: Terminal block 5x4mm². Two cable entries.
Design: Per Sundstedt.

ART	DESCRIPTION		PRICE/EUR
5087121	PS 5 ceiling fixture	IP20 75W/E27 H295 D222	260,07
5187121	PS5 ceiling fixture opal	IP20 26-42W/Gx24q HF	334,01
5187121HF-F	Ps 5 ceiling fixture opal	IP20 42W/Gx24q-4 HFF	411,27

HFF = Dimmable with SwitchDIM, DSI or DALI. 1-10V on request.

ACCESSORIES

95186101	PS5/PS6 reflector		52,26
95187182	PS5/PS6 distance piece	for external mains cable	29,93



PS 6

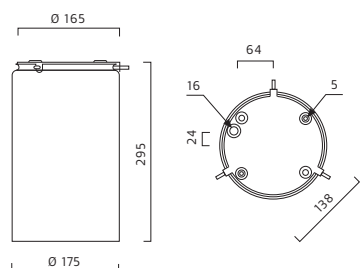

Finish: Chromed steel. Shade in matt opal glass. Aluminium reflector as accessory.
Installation: Ceiling-installation.
Connection: Terminal block 5x4mm². Two cable entries.
Design: Per Sundstedt.

ART	DESCRIPTION		PRICE/EUR
5086121	PS 6 ceiling fixture	IP20 75W/E27 H295 D175	260,07
5186121	PS6 ceiling fixture opal	IP20 26-42W/Gx24q HF	334,01
5186121HF-F	PS6 ceiling fixture opal	IP20 42W/Gx24q-4 HFF	411,27

HFF = Dimmable with SwitchDIM, DSI or DALI. 1-10V on request.

ACCESSORIES

95186101	PS5/PS6 reflector		52,26
95187182	PS5/PS6 distance piece	for external mains cable	29,93



GLOBUS

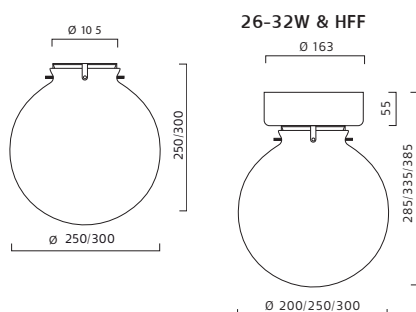

Finish: Chromed steel. Globe in matt opal glass.
Installation: Ceiling-installation.
Connection: Terminal block 3x4mm². Two cable entries. Knockout for external mains cable.
Design: Per Sundstedt.

ART	DESCRIPTION		PRICE/EUR
5080382	GLOBUS ceiling fixture white s	IP20 75W/E27 D250 mm	175,15
5080582	GLOBUS ceiling fixture white s	IP20 75W/E27 D300 mm	201,13
5180382	GLOBUS ceiling fixture white s	IP20 18W/Gx24q-2 HF D250 mm	297,77
5180382HF-F	GLOBUS ceiling fixture white s	IP20 18W/Gx24q-2 HFF D250 mm	444,49
5180582	GLOBUS ceiling fixture white s	IP20 18W/Gx24q-2 HF D300 mm	323,73
5180582HF-F	GLOBUS ceiling fixture white s	IP20 18W/Gx24q-2 HFF D300 mm	470,22
5180782	GLOBUS ceiling fixture white s	IP20 26-32W/Gx24q-3 HF D300 mm	496,77
5180782HF-F	GLOBUS ceiling fixture white s	IP20 32W/Gx24q-3 HFF D300 mm	638,43

HFF = Dimmable with SwitchDIM, DSI or DALI. 1-10V on request.



GLOBUS

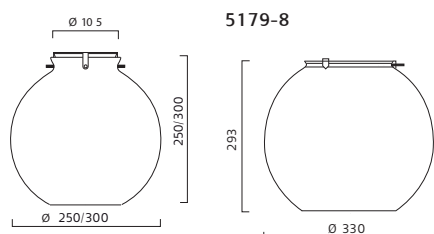

Finish: Chromed steel. Globe in matt opal glass. 5179-8: Aluminium reflector as accessory.

Installation: Ceiling-installation.

Connection: Snap-in terminal block 3x4mm². Two cable entries. Knockout for external mains cable.

Design: Per Sundstedt.

ART	DESCRIPTION	PRICE/EUR
5079382	GLOBUS ceiling fixture white s IP20 75W/E27 D250 open	180,33
5079582	GLOBUS ceiling fixture white s IP20 75W/E27 D300 open	206,30
5179382	GLOBUS ceiling fixture white s IP20 18W/Gx24q-2 HF D250 open	303,19
5179482	GLOBUS ceiling fixture white IP20 18W/Gx24q-2 HF D250 open	303,19
5179482HF-F	GLOBUS ceiling fixture D250 mm IP20 18W/Gx24q-2 HF	449,79
5179582	GLOBUS ceiling fixture white s IP20 18W/Gx24q-2 HF D300 open	328,91
5179582HF-F	GLOBUS ceiling fixture white o IP20 18W/Gx24q-2	475,53
5179782	GLOBUS ceiling fixture white s 26-32W/Gx24q-2 HF D300 open	502,74
5179782HF-F	GLOBUS ceilinglamp open globe IP20 32W/Gx24q-3 D300 mm	712,11
5179882	GLOBUS ceiling fixture white s 26-42W/Gx24q-3 HF D330 open	466,51



PS-KLOCKA

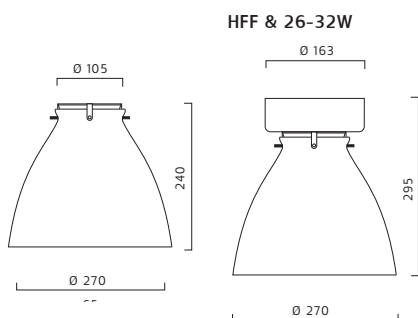

Finish: Chromed steel. Shade in matt opal glass. For HFF and 26-32W versions the ceiling rose is white-painted.

Installation: Ceiling-installation.

Connection: Terminal block 3x4mm². Two cable entries. Knockout for external mains cable.

Design: Per Sundstedt.

ART	DESCRIPTION	PRICE/EUR
5085182	PS-KLOCKA ceiling fixture whit IP20 75W/E27 H240 mm	237,67
5185182	PS-KLOCKA ceiling fixture whit IP20 13W/G24q-1 HF H240 mm	371,09
5185382	PS-KLOCKA ceiling fixture whit IP20 18W/Gx24q-2 HF H240 mm	371,09
5185382HF-F	PS-KLOCKA ceiling fixture whit IP20 18W/Gx24q-2 HFF H295 mm	517,19
5185782	PS-KLOCKA ceiling fixture whit IP20 26-32W/Gx24q-3 HF H295	488,42
5185782HF-F	PS-KLOCKA ceiling fixture whit IP20 32/Gx24q-3 HFF H295 mm	517,19

HFF = Dimmable with SwitchDIM, DSI or DALI. 1-10V on request.



PS 1



Finish: Chromed steel. Shade in matt opal glass. For HFF and 26-32W versions the ceiling rose is white-painted.

Installation: Ceiling-installation.

Connection: Terminal block 3x4mm². Two cable entries. Knockout for external mains cable.

Design: Per Sundstedt.

ART	DESCRIPTION	PRICE/EUR
5078101	PS 1 ceiling fixture white sha IP20 75W/E27 D275 mm	261,31
5178101	PS 1 ceiling fixture white sha IP20 13W/G24q-1 HF D275 mm	500,76
5178201	PS 1 ceiling fixture white sha IP20 18W/Gx24q-2 HF D275 mm	360,29
5178201HF-F	PS 1 ceiling fixture white sha IP20 18W/Gx24q-2 HFF D275 mm	517,19
5178501	PS 1 ceiling fixture white sha IP20 26-32W/Gx24q-3 HF D275 mm	517,19
5178501HF-F	PS 1 ceiling fixture white sha IP20 32W/Gx24q-3 HFF D275 mm	610,47

HFF = Dimmable with SwitchDIM, DSI or DALI. 1-10V on request.

BAFFY

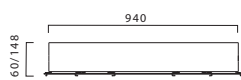
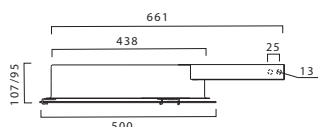
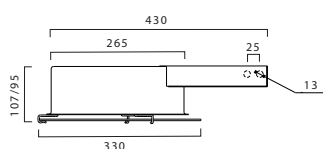

Finish: White painted steel. Matt optical glass. Diffuser in opal acrylic above glass is standard for size 1000 mm, available as accessory for sizes 330 och 500.

Installation: Recessed.

Connection: Snap-in terminal block 5x4mm². Two entry holes.

Design: Per Sundstedt.

ART	DESCRIPTION	PRICE/EUR
7400101HF	BAFFY Downlights white shade IP20 2x24W/2G10 HF D330 mm	450,27
7400101HF-F	BAFFY Downlights white shade IP20 2x24W/2G10 HFF D330 mm	523,86
7400301HF	BAFFY Downlights white shade IP20 4x24W/2G10 HF D500	597,30
7400301HF-F	BAFFY Downlights white shade IP20 4X24W/2G10 HFF D500	755,14
7400501HF	BAFFY Downlights white shade IP20 6x36W/2G11 HF D1000	1 655,60
7400501HF-F	BAFFY Downlights white shade 6x36W/2G11 HFF D1000 mm	1 865,57
7401101HF	BAFFY Downlights white shade IP20 1x22W/2Gx13 HF D330	471,63
7401101HF-F	BAFFY Downlights white shade IP20 1x22W/2Gx13 HFF D330	549,02
7401301HF	BAFFY Downlights white shade IP20 40+22W/2Gx13 HF D500	651,57
7401301HF-F	BAFFY Downlights white shade IP20 40+22W/2Gx13 HFF D500	827,26
7404101	BAFFY Downlights D330 HF white IP20 LED/1800LM/15,3W/3000K	424,86
7404101HF-F	BAFFY Downlight D330 HFF white IP20 LED/1800LM/15,3W/3000K	513,97
7404301	BAFFY Downlights D500 HF white IP20 LED/1800LM/15,3W/3000K	563,58
7404301HF-F	BAFFY Downlight D500 HFF white IP20 LED/1800LM/15,3W/3000K	648,24

With motion detector

7404101S	BAFFY Downlights D330 HF white IP20 LED/1800LM/15,3W/3000K	493,82
7404101HFFS	BAFFY Downlight D330 HFF white IP20 LED/1800LM/15,3W/3000K	582,93
7404301S	BAFFY Downlights D500 HF white IP20 LED/1800LM/15,3W/3000K	632,54
7404301HFFS	BAFFY Downlight D500 HFF white IP20 LED/1800LM/15,3W/3000K	717,20

HFF = Dimmable with SwitchDIM, DSI or DALI. 1-10V on request.

ACCESSORIES

97400101	BAFFY support-frame D330 mm L: 588, B: 366, Hole 272	36,79
----------	--	-------

CYLI 1



Finish: White- or grey painted steel. Matt opalglass.

Montage: Semi-recessed.

Connection: Snap-in terminal block 5x4mm². Two entry holes.

ART	DESCRIPTION	PRICE/EUR
4004101HF	CYLI 1 Downlight white glass IP20 2x18W/G24q-2 HF white	467,95
4004101HF-F	CYLI 1 Downlight white glass IP20 2x18W/G24q-2 HFF white	552,56
4004138HF	CYLI 1 Downlight white glass IP20 2x18W/G24q-2 HF grey	467,95
4004138HF-F	CYLI 1 Downlight white glass IP20 2x18W/G24q-2 HFF grey	552,56
4005101HF	CYLI 1 Downlight white glass IP20 1x18W/G24q-2 HF white	336,04
4005101HF-F	CYLI 1 Downlight white glass IP20 1x18W/G24q-2 HFF white ci	518,26
4005138HF	CYLI 1 Downlight white glass IP20 1x18W/G24q-2 HF grey	336,04
4005138HF-F	CYLI 1 Downlight white glass IP20 1x18W/G24q-2 HFF grey	518,26

HFF = Dimmable with SwitchDIM, DSI or DALI. 1-10V on request.

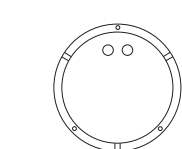
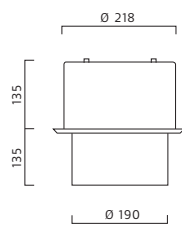

Art. 4000 IP23

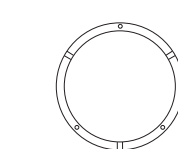
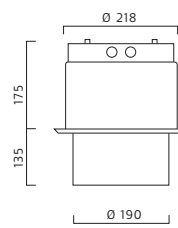

Art. 4003, and HF & HFF IP20

CONVEX

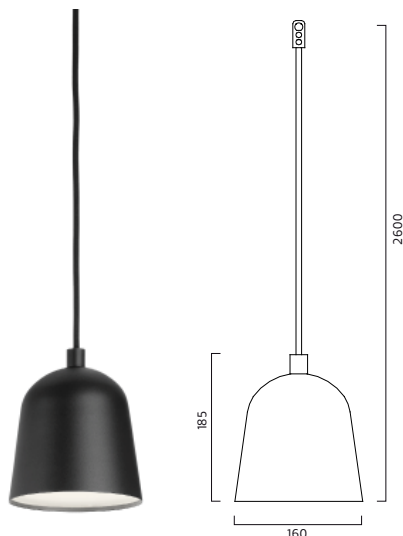

Finish: Painted aluminium, micro prisma. Textile cable in matching colors.
 Orange RAL 2004.
Installation: Pendant, 2 m cable.
Connection: Terminal block 2x2,25mm².
Design: Jens Fager 2014.

ART	DESCRIPTION		PRICE/EUR
8291101	CONVEX pendant white	IP20 Max 28W/E27 D160 mm	278,10
8291106	CONVEX pendant black	IP20 Max 28W/E27 D160 mm	278,10
8291141	CONVEX pendant orange	IP20 Max 28W/E27 D160 mm	290,46

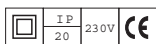

FOG

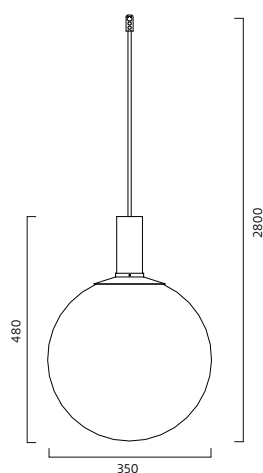

Finish: Painted steel. Shade in partly sand blasted clear glass. Incl. light source.
Installation: In ceiling hook, 2 m cable.
Connection: Terminal block 3x2,25mm².
Design: Front 2014.

ART	DESCRIPTION		PRICE/EUR
8310301	FOG pendant glass/white	IP20 8W/GU10 LED D350 mm	449,60
8310306	FOG pendant glass/black	IP20 8W/GU10 LED D350 mm	449,60
8310378	FOG pendant glass/copper	IP20 8W/GU10 LED D350 mm	467,21

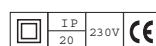

SHIBUYA

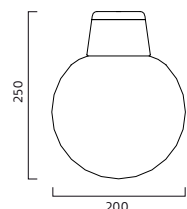
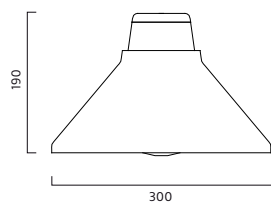

Finish: Painted aluminum. Red RAL 0405070, grey RAL 0005000, other colors on request. Shade in painted aluminium or glass. Cable up to 1,5 m is included in line system mounting. Longer lengths on request.
Installation: Wire fitting.
Connection: Cable with plug
Design: Thomas Bernstrand 2014

ART	DESCRIPTION		PRICE/EUR
FIXTURE			
8218101	SHIBUYA pendant fitting white	start cable line mounting	282,22
8218107	SHIBUYA pendant fitting red	start cable line mounting	287,37
8218195	SHIBUYA pendant fitting grey	start cable line mounting	287,37
8219101	SHIBUYA pendant fitting white	plus cable line mounting	282,22
8219107	SHIBUYA pendant fitting red	plus cable line mounting	287,37
8219195	SHIBUYA pendant fitting grey	plus cable line mounting	287,37
8221101	SHIBUYA pendant fitting white	end cable line mounting	282,22
8221107	SHIBUYA pendant fitting red	end cable line mounting	287,37
8221195	SHIBUYA pendant fitting grey	end cable line mounting	287,37

ART	DESCRIPTION		PRICE/EUR
SHADES			
8223101	SHIBUYA shade alu white	D300 mm	117,73
8223107	SHIBUYA shade alu red	D300 mm	191,89
8223195	SHIBUYA shade alu grey	D300 mm	191,89
8224107	SHIBUYA glass shade red	D200 mm	122,36
8224111	SHIBUYA glass shade grey	D200 mm	122,36
8224116	SHIBUYA glass shade cognac	D200 mm	161,22,36



SHIBUYA



Finish: Painted aluminum. White or Red RAL 0405070, grey RAL 0005000, other colors on request. Shade in painted aluminium or glass.

Installation: In ceiling hook.

Connection: Terminal block 3x2,25mm².

Design: Thomas Bernstrand 2014

ART	DESCRIPTION	PRICE/EUR
FIXTURES		
8220101	SHIBUYA pendant fitting white single mounting	239,60
8220107	SHIBUYA pendant fitting red single mounting	244,73
8220195	SHIBUYA pendant fitting grey single mounting	244,73
SHADES		
8223101	SHIBUYA shade alu white D300 mm	117,73
8223107	SHIBUYA shade alu red D300 mm	191,89
8223195	SHIBUYA shade alu grey D300 mm	191,89
8224107	SHIBUYA glass shade red D200 mm	122,36
8224111	SHIBUYA glass shade grey D200 mm	122,36
8224116	SHIBUYA glass shade cognac D200 mm	122,36

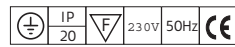

TUTTI FRUTTI

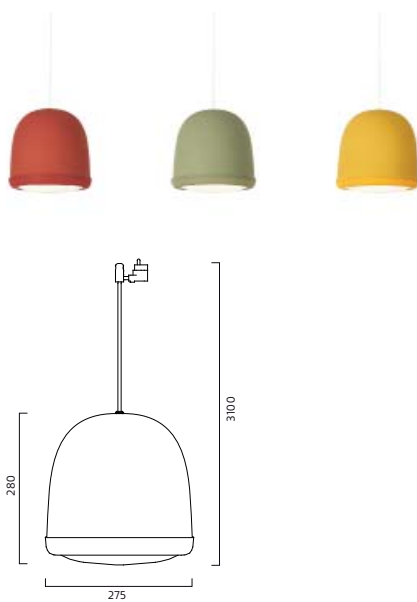

Finish: Rubber painted aluminum, silicon ring. diffusor in matt acrylic.

Red RAL 3002, green RAL 6021, yellow RAL 1006.

Installation: In ceiling hook, 3 m cable.

Connection: Terminal block 3x4mm².

Design: Paolo Dell'Elce 2014.

ART	DESCRIPTION	PRICE/EUR
8112107	TUTTI FRUTTI pendant red D270 IP20 E27/max 28W RAL3002	303,13
8112112	TUTTI FRUTTI pendant green D270 IP20 E27/max 28W RAL6021	303,13
8112114	TUTTI FRUTTI pendant yellow D270 IP20 E27/max 28W RAL1006	303,13

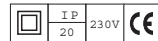

LOOS



Finish: 2 or 3 shades in pressed felt. The light source is covered by an opal acrylic diffuser. The shades are turnable. Specify the shades from outside to inside.

Installation: In ceiling-hook, wire pendant

Connection: Terminal block 2x2,25mm².

Design: Luca Nichetto 2013.

ART	DESCRIPTION	PRICE/EUR
8275296	LOOS pendant for 2 shades IP20 E27/Max 42W	149,61
8275396	LOOS pendant for 3 shades IP20 E27/Max 42W	149,61
SHADES		
8280101A	LOOS shade off white	207,29
8280111C	LOOS shade grey	207,29
8280114A	LOOS shade yellow/ Europost 62061	252,35
8280141B	LOOS shade orange/ Europost 63016	252,35
8280186B	LOOS shade antracite	207,29
8280195C	LOOS shade warm grey Europost 61003	252,35

Mönster A/Pattern A



Mönster B/Pattern B

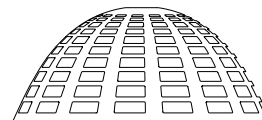

Mönster C/Pattern C

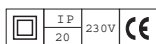
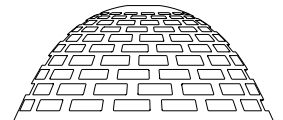

SILO



Finish: Painted aluminium. Textile cable in matching colors.

Installation: Pendant, 2 m cable.

Connection: Terminal block 2x2,25mm².

Design: Note Design Studio 2013.

ART	DESCRIPTION		PRICE/EUR
8205101	SILO pendant lamp white	IP20 E27 max 42W	186,58
8205106	SILO pendant lamp black	IP20 E27 max 42W	186,58
8205112	SILO pendant lamp green	IP20 E27 max 42W	199,94
8205114	SILO pendant lamp yellow	IP20 E27 max 42W	199,94

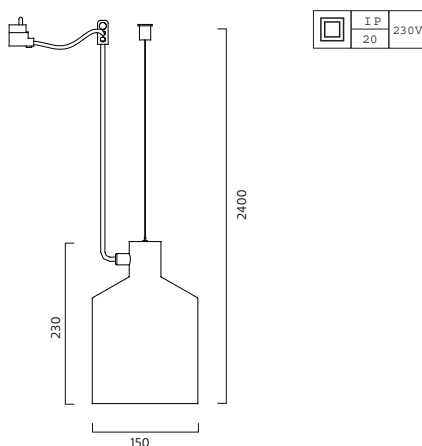

SILO TRIO



Finish: Painted aluminum and steel. Diffusor in matt acrylic.

Green RAL 6021, yellow RAL 1018.

Installation: Ceiling-hook. 2 m wire pendant.

Connection: Terminal block 2x2,25mm².

Design:

ART	DESCRIPTION		PRICE/EUR
8207301	SILO Trio pendant white	IP20 3xE27 max 42W L1050 mm	654,46
8207306	SILO Trio pendant black	IP20 3xE27 max 42W L1050 mm	654,46
8207312	SILO Trio pendant green	IP20 3xE27 max 42W L1050 mm	690,51
8207314	SILO Trio pendant yellow	IP20 3xE27 max 42W L1050 mm	690,51

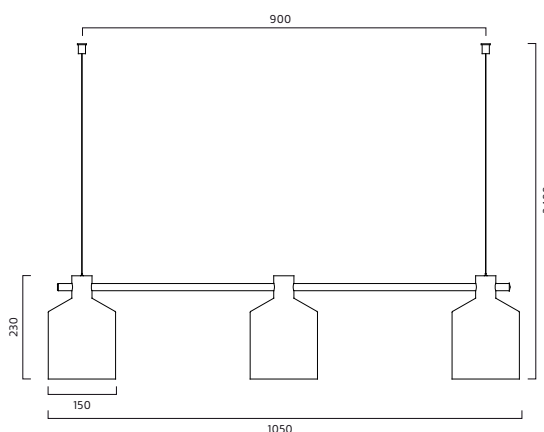
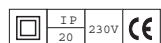

DAIKANYAMA

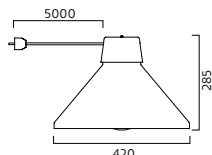

Finish: Painted aluminium. Diffuser in opal glass.

Installation: On wire. Wire and mounting details available as accessories.

Connection: 5 m cable with plug. Other lengths on request

Design: Thomas Bernstrand 2013.

ART	DESCRIPTION	PRICE/EUR
8252101	DAIKANYAMA p wire fitting IP20 E27 D420 mm white	483,79
8252106	DAIKANYAMA p wire fitting IP20 E27 D420 mm black	570,31
8252107	DAIKANYAMA p wire fitting IP20 E27 D420 mm red	570,31
8252114	DAIKANYAMA p wire fitting IP20 E27 D420 mm yellow	570,31
8252141	DAIKANYAMA p wire fitting IP20 E27 D420 mm orange	570,31
8255101	DAIKANYAMA p wire fitting IP20 18W/Gx24q D420 white	512,61
8255106	DAIKANYAMA p wire fitting IP20 18W/Gx24q D420 black	599,43
8255107	DAIKANYAMA p wire fitting IP20 18W/Gx24q D420 red	599,43
8255114	DAIKANYAMA wire fitting IP20 18W/Gx24q D420 yellow	599,43
8255141	DAIKANYAMA p wire fitting IP20 18W/Gx24q D420 orange	599,43
8256101	DAIKANYAMA p wire fitting IP20 LED D420 mm white	613,90
8256106	DAIKANYAMA p wire fitting IP20 LED D420 mm black	700,72
8256107	DAIKANYAMA p wire fitting IP20 LED D420 mm red	700,72
8256114	DAIKANYAMA wire fitting yellow IP20 LED D420 mm	700,72
8256141	DAIKANYAMA p wire fitting IP20 LED D420 mm orange	700,72
ACCESSORIES		
98255101	Wire 3 mm	2,47
98255201	Daikanyama turnbuckle	13,39
98255301	Frech Screw with loop	10,30
98255401	Wire-Lock	1,96

DAIKANYAMA

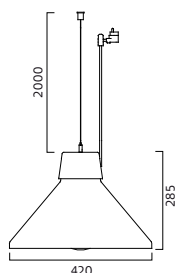

Finish: Painted aluminum and opal glass. Red RAL 3020, yellow RAL 1023, orange RAL 2004.

Installation: In ceiling hook, 2 m cable and wire.

Connection: Terminal block 3x2,25mm².

Design: Thomas Bernstrand 2014.

ART	DESCRIPTION	PRICE/EUR
8257101	DAIKANYAMA pendant white IP20 18W/Gx24q HF D420 mm	546,25
8257106	DAIKANYAMA pendant black IP20 18W/Gx24q HF D420 mm	633,07
8257107	DAIKANYAMA pendant red IP20 18W/Gx24q HF D420 mm	633,07
8257114	DAIKANYAMA pendant orange IP20 18W/Gx24q HF D420 mm	633,07
8257141	DAIKANYAMA pendant orange IP20 18W/Gx24q D420 mm	633,07
8258101	DAIKANYAMA pendant white IP20 LED D420 mm	647,54
8258106	DAIKANYAMA pendant black IP20 LED D420 mm	734,37
8258107	DAIKANYAMA pendant red IP20 LED D420 mm	734,37
8258114	DAIKANYAMA pendant yellow IP20 LED D420 mm	734,37
8258141	DAIKANYAMA pendant orange IP20 LED D420 mm	734,37
8259101	DAIKANYAMA pendant white IP20 E27 D420 mm	517,32
8259106	DAIKANYAMA pendant black IP20 E27 D420 mm	603,84
8259107	DAIKANYAMA pendant red IP20 E27 D420 mm	603,84
8259114	DAIKANYAMA pendant yellow IP20 E27 D420 mm	603,84
8259141	DAIKANYAMA pendant orange IP20 E27 D420 mm	603,84



HATT

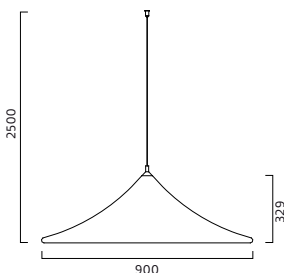

Finish: White stretch fabric with painted metal parts in white or yellow. Other colours on request.

Installation: Ceiling hook, with 2 m cable.

Connection: Terminal block 3x2,25mm². When HFF 5x4mm².

Design: Thomas Sandell 2013

ART	DESCRIPTION		PRICE/EUR
8235101	HATT pendant white/white	IP20 40W/2Gx13 HF D800 mm	1 225,70
8235101HF-F	HATT pendant white/white	IP20 40W/2Gx13 HFF D800 mm	1 288,79
8235114	HATT pendant white/yellow	IP20 40W/2Gx13 HF D800 mm	1 225,70
8235114HF-F	HATT pendant white/yellow	IP20 40W/2Gx13 HFF D800 mm	1 288,79

HFF = Dimmable with SwitchDIM, DSI or DALI. 1-10V on request.



JEAHNA

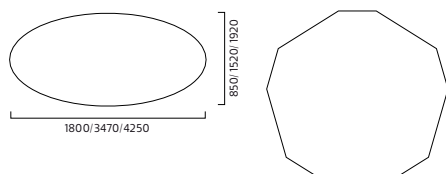

Finish: White polyester fabric and black aluminium tubes. Shade and light fixture is ordered separately. It's also possible to install Jeahna without light fixture.

Installation: Ceiling-hook. 5 m wire pendant. Other lengths on request.

Connection: 5 m cable with plug. When HFF without plug.

Design: Johan Carpner & Alexander Lervik 2013.

ART	DESCRIPTION		PRICE/EUR
8270101	JEAHNA pendant D1800 H850	Shade only	3 833,92
8270301	JEAHNA pendant D3470 H1520	Shade only	4 204,34
8270501	JEAHNA pendant D4250 H1920	Shade only	6 229,44
8271101	JEAHNA IP20 26-42W/Gx24q HF	lighting fitting	324,45
8271101HF-F	JEAHNA IP20 26-42W/Gx24q HFF	lighting fitting	387,90
8271301	JEAHNA IP20 3x26-42W/Gx24q HF	Lighting fitting	363,38
8271301HF-F	JEAHNA IP20 3x26-42W/Gx24q HFF	Lighting fitting	490,28
8272101	JEAHNA light fixture	IP20 LED	Price on request
8272101HFF	JEAHNA light fixture	IP20 LED HFF	Price on request
8273101	JEAHNA light fixture	IP20 LED RGB	Price on request

HFF = Dimmable with SwitchDIM, DSI or DALI. 1-10V on request.



CORD

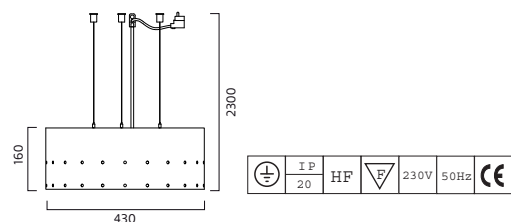

Finish: Base in white painted metal. Diffuser in matt acrylic. Rubber bands in different colors.

Possible to mix two colors on request.

Installation: Ceiling.

Connection: Terminal block 3x4mm², when HFF terminal block 5x4mm².

Design: Mia Cullin 2012.

ART	DESCRIPTION		PRICE/EUR
82101-XX	CORD pendant white/	IP20 40W/2G13 HF D413 mm	764,91
82101-XXHF-F	CORD pendant white/	IP20 40W/2G13 HFF D413 mm	816,89
82103-XX	CORD pendant white/	IP20 40W/2G13 HF D600 mm	1 032,26
82103-XXHF-F	CORD pendant white/	IP20 40W/2G13 HFF D600 mm	1 084,24
82111-XX	CORD pendant white/	IP20 55W/2G13 HF D413 mm	764,91
82111-XXHF-F	CORD pendant white/	IP20 55W/2G13 HFF D413 mm	816,89
82113-XX	CORD pendant white/	IP20 55W/2G13 HF D600 mm	1 032,26
82113-XXHF-F	CORD pendant white/	IP20 55W/2G13 HFF D600 mm	1 084,24
82151-XX	CORD pend D413 HF/	IP20 LED/1800LM/15,3W/3000K	851,21
82151-XXHF-F	CORD pend D413 HFF/	IP20 LED/1800LM/15,3W/3000K	940,33
82153-XX	CORD pend D600 HF/	IP20 LED/1800LM/15,3W/3000K	1 036,87
82153-XXHF-F	CORD pend D600 HFF/	IP20 LED/1800LM/15,3W/3000K	1 125,99

HFF = Dimmable with SwitchDIM, DSI or DALI. 1-10V on request.

XX = -01 white, -06 black, -12 green, -14 yellow, -41 orange.

PAR

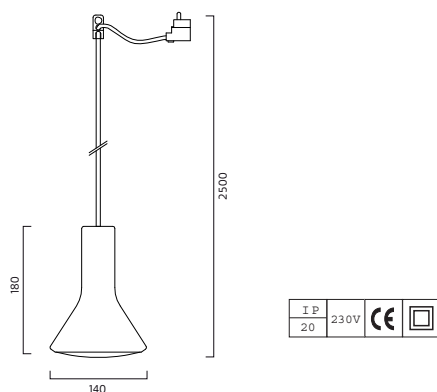

Finish: Painted aluminium. Textile cable in matching colors. Incl. lightsource.

Installation: Pendant, 2 m cable.

Connection: Terminal block 2x2,25mm².

Design: Broberg & Ridderstråle 2012.

ART	DESCRIPTION		PRICE/EUR
8190101	PAR pendant D140 mm white	IP20 50W/PAR38 halogen	138,13
8190106	PAR pendant D140 mm black	IP20 50W/PAR38 halogen	138,13
8190141	PAR pendant D140 mm orange	IP20 50W/PAR38 halogen RAL2004	138,13
8190194	PAR pendant D140 mm blue	IP20 50W/PAR38 halogen RAL5014	138,13
8190195	PAR pendant D140 mm warmgrey	IP20 50W/PAR38 halogen RAL7004	138,13
8192101	PAR pendant D140 mm white	IP20 16W/PAR38 LED	227,25
8192101HF-F	PAR pendant D140 mm white	IP20 20W/PAR38 LED dimmable	348,96
8192106	PAR pendant D140 mm black	IP20 16W/PAR38 LED	227,25
8192106HF-F	PAR pendant D140 mm black	IP20 20W/PAR38 LED dimmable	348,96
8192141	PAR pendant D140 mm orange	IP20 16W/PAR38 LED RAL2004	227,25
8192141HF-F	PAR pendant D140 mm orange	IP20 20W/PAR38 LED dimmable	348,96
8192194	PAR pendant D140 mm blue	IP20 16W/PAR38 LED RAL5014	227,25
8192194HF-F	PAR pendant D140 mm blue	IP20 20W/PAR38 LED dimmable	348,96
8192195	PAR pendant D140 mm warmgrey	IP20 16W/PAR38 LED RAL7004	227,25
8192195HF-F	PAR pendant D140 mm grey	IP20 20W/PAR38 LED dimmable	348,96

PISTILL

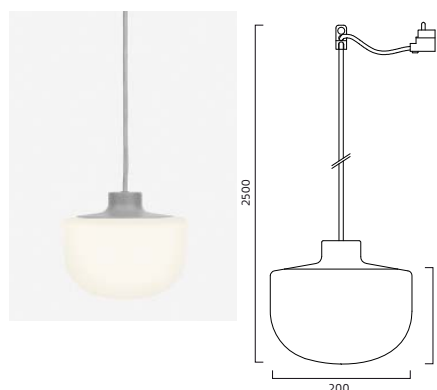

Finish: Base in painted aluminium. Shade in matt opal UV-stable polyethene. Textile cable in matching colors. Incl. lightsource.

Installation: Ceiling hook.

Connection: Terminal block 3x2,25mm².

Design: Jens Fager 2012.

ART	DESCRIPTION		PRICE/EUR
8093101	PISTILL pendant lamp white	IP20 10-13W/Gx24q HF D200 mm	349,04
8093141	PISTILL pendant lamp orange	IP20 10-13W/Gx24q HF D200 mm	349,04
8093195	PISTILL pendant lamp grey	IP20 10-13W/Gx24q HF D200 mm	349,04
8094101	PISTILL pendant lamp white	IP55 7W/E27/Mini Twist D200 mm	323,79
8094141	PISTILL pendant lamp orange	IP55 7W/E27/Mini Twist D200 mm	323,79
8094195	PISTILL pendant lamp grey	IP55 7W/E27/Mini Twist D200 mm	323,79
8095101	PISTILL pendant opal/white	IP20 LED/4 W D200 mm	345,72
8095141	PISTILL pendant orange	IP20 LED/4 W D200 mm	345,72
8095195	PISTILL pendant opal/grey	IP20 LED/4 W D200 mm	345,72



LIFT

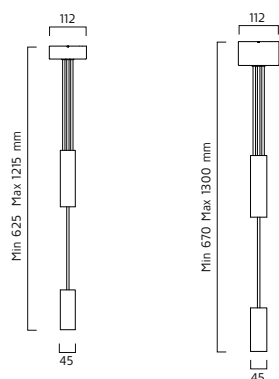

Finish: Painted aluminium. Height adjustable. Light source included.

Installation: Ceiling, other heights on request.

Connection: Terminal block 3x4mm².

Design: Fredrik Mattson 2012.

ART	DESCRIPTION		PRICE/EUR
8230101	LIFT pendant lamps white	IP20 MAX PAR38 50W	377,68
8230106	LIFT pendant lamps black	IP20 MAX PAR38 50W	377,68
8230141	LIFT pendant lamps orange	IP20 MAX PAR38 50W	377,68
8230196	LIFT pendant lamps grey	IP20 MAX PAR38 50W	377,68
8231101	LIFT pendant lamps white	IP20 5W/LED/3000K	579,25
8231106	LIFT pendant lamps black	IP20 5W/LED/3000K	579,25
8231141	LIFT pendant lamps orange	IP20 5W/LED/3000K	579,25
8231196	LIFT pendant lamps grey	IP20 5W/LED/3000K	579,25

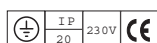

FISHERMAN

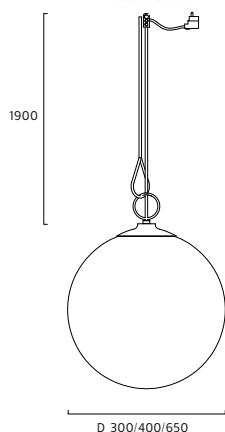

Finish: Shade in opal UV-stable polyethene. Handmade net in white, orange or natural. Other colors on request.

Installation: Pendant, 1,9 m cable and rope.

Connection: Terminal block 3x2,25mm². When HFF 5x4mm².

Design: Mattias Ståhlbom 2011.

ART	DESCRIPTION		PRICE/EUR
8186001	FISHERMAN pendant opal/white	IP20 E27 D300 mm	545,83
8186041	FISHERMAN pendant opal/orange	IP20 E27 D300 mm	545,83
8186050	FISHERMAN pendant opal/natural	IP20 E27 D300 mm	545,83
8186101	FISHERMAN pendant opal/white	IP20 E27 D400 mm	565,88
8186141	FISHERMAN pendant opal/orange	IP20 E27 D400 mm	565,88
8186150	FISHERMAN pendant opal/nature	IP20 E27 D400 mm	565,88
8186301	FISHERMAN pendant opal/white	IP20 E27 D650 mm	908,98
8186341	FISHERMAN pendant opal/orange	IP20 E27 D650 mm	908,98
8186350	FISHERMAN pendant opal/nature	IP20 E27 D650 mm	908,98
8187101	FISHERMAN pendant opal/white	IP20 26-42W/Gx24q HF D400 mm	657,15
8187101HF-F	FISHERMAN pendant opal/white	IP20 42W/Gx24q HFF D400 mm	716,12
8187141	FISHERMAN pendant opal/orange	IP20 26-42W/Gx24q HF D400 mm	657,15
8187141HF-F	FISHERMAN pendant opal/orange	IP20 42W/Gx24q HFF D400 mm	716,12
8187150	FISHERMAN pendant opal/natural	IP20 26-42W/Gx24q HF D400 mm	657,15
8187150HF-F	FISHERMAN pendant opal/natural	IP20 42W/Gx24q HFF D400 mm	716,12
8187301	FISHERMAN pendant opal/white	IP20 26-42W/Gx24q HF D650 mm	1 012,26
8187301HF-F	FISHERMAN pendant opal/white	IP20 42W/Gx24q HFF D650 mm	1 071,23
8187341	FISHERMAN pendant opal/orange	IP20 26-42W/Gx24q HF D650 mm	1 012,26
8187341HF-F	FISHERMAN pendant opal/orange	IP20 42W/Gx24q HFF D650 mm	1 071,23
8187350	FISHERMAN pendant opal/natural	IP20 26-42W/Gx24q HF D650 mm	1 012,26
8187350HF-F	FISHERMAN pendant opal/natural	IP20 42W/Gx24q HFF D650 mm	1 071,23



Kompaktlysör 26-42W/Compact fluorescent 26-42W

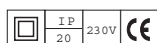

TRAPETS

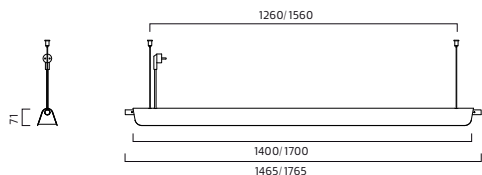

Finish: White painted metal, other colors on request. Wood knobs in natural ash or stained yellow or white as standard, other stains on request. Diffuser of microprisma. T5 Eco.

Installation: Pendant, 2 m wire.

Connection: Plug or terminal block 5x4mm².

Design: Note Design Studio 2011.

ART	DESCRIPTION	PRICE/EUR
8200101	TRAPETS pendant L1400 white IP20 T5 25/28/50/54W HF	646,09
8200101HF-F	TRAPETS pendant L1400 white IP20 T5 25/28/50/54W HF-F	705,50
8200301	TRAPETS pendant L1700 white IP20 T5 32/35/45/49W HF	683,22
8200301HF-F	TRAPETS pendant L1700 white IP20 T5 32/35/45/49W HF-F	742,63
8201101	TRAPETS pendant L1400 upplight IP20 25/28/50/54W T5 HF white	737,88
8201101HF-F	TRAPETS pendant L1400 upplight IP20 25/28/50/54W T5 HFF white	797,46
8201301	TRAPETS pendant L1700 upplight IP20 32/35/45/49W T5 HF white	774,54
8201301HF-F	TRAPETS pendant L1700 white IP20 25/28/50/54W T5 HFF white	876,90

LED 2600 Lumen

8202101	TRAPETS pendant L1400 mm white IP20 LED 2600LM/22W	838,71
8202101HF-F	TRAPETS pendant L1400 mm white IP20 LED 2600LM/22W	967,05

LOOM

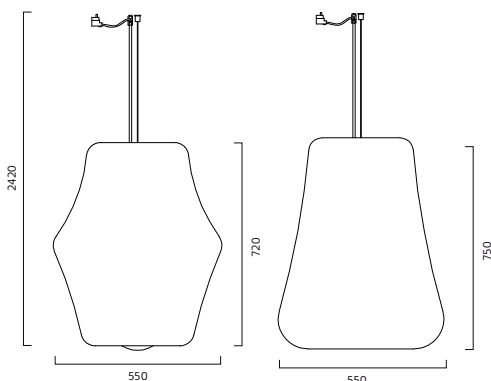

Finish: 3D woven spacer of polyester. Seam in different colors to be ordered separately. Seam and shape are hand made = all are a bit different.

Diameter 550 mm, height 700 mm.

Installation: Ceiling, wire pendant.

Connection: Terminal block 3x4mm², when HFF terminal block 5x4mm².

Design: Benjamin Hubert 2011.

ART	DESCRIPTION	PRICE/EUR
8160179	LOOM pendant lamp lantern shade IP20 26-32W/Gx24q D550 H700	1 361,46
8160179HF-F	LOOM pendant lamp lantern shade IP20 32W/Gx24q HFF D550 H700	1 412,93
8161179	LOOM pendant lamp bell shade IP20 26-32W/Gx24q D550 H700	1 278,81
8161179HF-F	LOOM pendant lamp bell shade IP20 32W/Gx24q HFF D550 H700	1 330,27

ACCESSORIES/ACCESSORIES

91860101	LOOM white seam	51,08
91860108	LOOM blue seam	51,08
91860110	LOOM dark grey seam	51,08
91860112	LOOM dark green seam	51,08
91860114	LOOM yellow seam	51,08
91860141	LOOM orange seam	51,08

HFF = Dimmable with SwitchDIM, DSI or DALI. 1-10V on request.



GRID

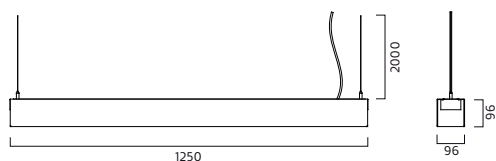

Finish: Perforated metal with square holes or expanded metal. Yellow, orange, clear painted metal or transparent gold varnish. Grid has a raw finish and one can see weldings through the transparent varnish.

Installation: Ceiling, pendant wire.

Connection: Cable and plug, when HFF without plug.

Design: Front 2011.

ART	DESCRIPTION	PRICE/EUR
81311XX	GRID pendant squarehole yellow IP20 25/28/50/54W T5 HF L1250	623,54
81311XXHF-F	GRID pendant squarehole yellow IP20 25/28/50/54W T5 HFF L1250	678,93
81321XX	GRID pendant expanded yellow IP20 25/28/50/54W T5 HF L1250	623,54
81321XXHF-F	GRID pendant expanded yellow IP20 25/28/50/54W T5 HFF L1250	678,93

LED 2600 Lumen

81311XX	GRID pendant squarehole yellow IP20 LED 2600LM/22W L1250	859,27
81311XXHF-F	GRID pendant squarehole yellow IP20 LED 2600LM/22W L1250	971,73
81321XX	GRID pendant expanded yellow IP20 LED 2600LM/22W L1250	859,27
81321XXHF-F	GRID pendant expanded yellow IP20 LED 2600LM/22W L1250	971,73

HFF = Dimmable with SwitchDIM, DSI or DALI. 1-10V on request.

XX = -14 Yellow, -41 Orange, -76 Metal, -77 Gold

LENS

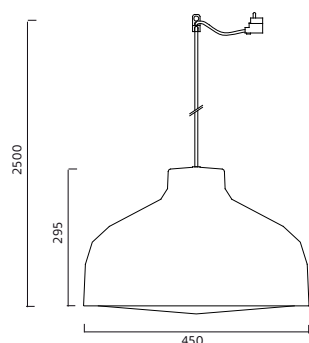

Finish: Structure painted aluminum and matt acrylic.

Installation: Ceiling-hook.

Connection: Terminal block 3x2,25mm when HFF cable without plug.

Design: Jens Fager 2010.

ART	DESCRIPTION		PRICE/EUR
8100301	LENS pendant lamp white	IP20 22W/2Gx13 HF D450 mm	766,35
8100301HF-F	LENS pendant lamp white	IP20 22W/2Gx13 HFF D450 mm	838,78
8100306	LENS pendant lamp black	IP20 22W/2Gx13 HF D450 mm	766,35
8100306HF-F	LENS pendant lamp black	IP20 22W/2Gx13 HFF D450 mm	838,78
8100501	LENS pendant lamp white	IP20 40W/2Gx13 HF D450 mm	821,93
8100501HF-F	LENS pendant lamp white	IP20 40W/2Gx13 HFF D450 mm	875,83
8100506	LENS pendant lamp black	IP20 40W/2Gx13 HF D450 mm	821,93
8100506HF-F	LENS pendant lamp black	IP20 40W/2Gx13 HFF D450 mm	875,83
8101301	LENS pendant lamp white	IP20 60W/E27 D450 mm	666,98
8101306	LENS pendant lamp black	IP20 60W/E27 D450 mm	666,98
8102301	LENS pendant D450 HF white	IP20 LED/2000Lm/830	814,71
8102301HF-F	LENS pendant HFF D450 white	IP20 LED/1800LM/15,3W/3000K	903,82
8102306	LENS pendant D450 HF black	IP20 LED/2000Lm/830	814,71
8102306HF-F	LENS pendant HFF D450 svart	IP20 LED/1800LM/15,3W/3000K	903,82

HFF = Dimmable with SwitchDIM, DSI or DALI. 1-10V on request.



LENS

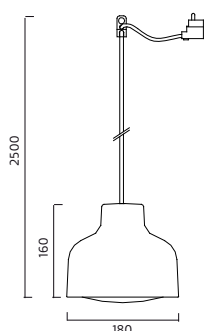

Finish: Structure painted aluminum and matt acrylic.

Installation: Ceiling-hook.

Connection: Terminal block 3x2,25mm when HFF cable without plug.

Design: Jens Fager 2010.

ART	DESCRIPTION		PRICE/EUR
8100101	LENS pendant lamp white	IP20 40W/E27 D180 mm	303,17
8100106	LENS pendent lamp black	IP20 40W/E27 D180 mm	303,17

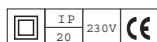

BEAM

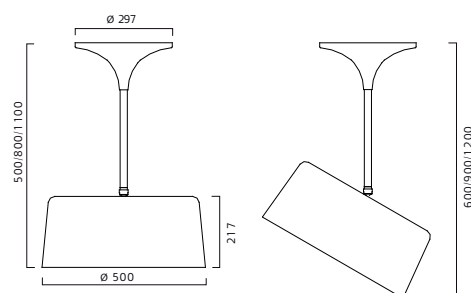

Finish: Painted aluminum and metal. Adjustable shade for indirect light.

Installation: Ceiling with pendant tube. Other lengths possible on request.

Connection: Terminal block 5x4 mm² Two entry holes..

Design: Johan Carpner 2010.

ART	DESCRIPTION		PRICE/EUR
8150101	BEAM pendant fixture white	IP20 26-42W/Gx24q HF D500 H500	897,73
8150101HF-F	BEAM pendant fixture white	IP20 42W/Gx24q HFF D500 H500	949,94
8150106	BEAM pendant fixture black	IP20 26-42W/Gx24q HF D500 H500	897,73
8150106HF-F	BEAM pendant fixture black	IP20 42W/Gx24q HFF D500 H500	949,94
8150107	BEAM pendant fixture red	IP20 26-42W/Gx24q HF D500 H500	897,73
8150107HF-F	BEAM pendant fixture red	IP20 42W/Gx24q HFF D500 H500	949,94
8150301	BEAM pendant fixture white	IP20 26-42W/Gx24q HF D500 H800	897,73
8150301HF-F	BEAM pendant fixture white	IP20 42W/Gx24q HFF D500 H800	949,94
8150306	BEAM pendant fixture black	IP20 26-42W/Gx24q HF D500 H800	897,73
8150306HF-F	BEAM pendant fixture black	IP20 42W/Gx24q HFF D500 H800	949,94
8150307	BEAM pendant fixture red	IP20 26-42W/Gx24q HF D500 H800	897,73
8150307HF-F	BEAM pendant fixture red	IP20 42W/Gx24q HFF D500 H800	949,94
8150501	BEAM pendant fixture white	IP20 26-42W/Gx24q HF H1 100 mm	897,73
8150501HF-F	BEAM pendant fixture white	IP20 42W/Gx24q HFF H1 100 mm	949,94
8150506	BEAM pendant fixture black	IP20 26-42W/Gx24q HF H1 100 mm	897,73
8150506HF-F	BEAM pendant fixture black	IP20 42W/Gx24q HFF H1 100 mm	949,94
8150507	BEAM pendant fixture red	IP20 26-42W/Gx24q HF H1 100 mm	897,73
8150507HF-F	BEAM pendant fixture red	IP20 42W/Gx24q HFF H1 100 mm	949,94

HFF = Dimmable with SwitchDIM, DSI or DALI. 1-10V on request.



UMBRELLA

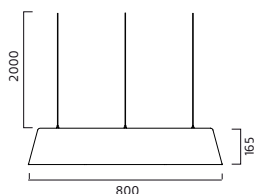

ART	DESCRIPTION	PRICE/EUR
7880301	UMBRELLA pendant lamp white IP20 4x36W/2G11 HF D800	1 051,63
7880301HF-F	UMBRELLA pendant lamp white IP20 4x36W/2G11 HFF D800	1 339,83
7880306	UMBRELLA pendant lamp black IP20 4x36W/2G11 HF D800	1 051,63
7880306HF-F	UMBRELLA pendant lamp black IP20 4x36W/2G11 HFF D800	1 339,83
7880312	UMBRELLA pendant lamp green IP20 4x36W/2G11 HF D800	1 051,63
7880312HF-F	UMBRELLA pendant lamp green IP20 4x36W/2G11 HFF D800	1 339,83
7882301	UMBRELLA pendant white D800 4x36W/2G11 HF down/uplight	1 142,77
7882301HF-F	UMBRELLA pendant white D800 4x36W/2G11 HFF down/uplight	1 430,97
7882306	UMBRELLA pendant black D800 4x36W/2G11 HF down/uplight	1 142,77
7882306HF-F	UMBRELLA pendant black D800 4x36W/2G11 HFF down/uplight	1 430,97
7882312	UMBRELLA pendant green D800 4x36W/2G11 HF down/uplight	1 142,77
7882312HF-F	UMBRELLA pendant green D800 4x36W/2G11 HFF down/uplight	1 430,97

HFF = Dimmable with SwitchDIM, DSI or DALI. 1-10V on request.

BLOOM

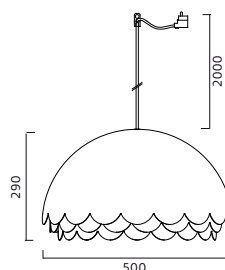

Finish: Painted aluminium and metal. Diffuser in matt akrylic.

Installation: Ceiling-hook.

Connection: Terminal block 3x4mm², when HFF 5x4mm².

Design: Fredrik Mattson 2009.

ART	DESCRIPTION	PRICE/EUR
7740101	BLOOM pendant lamp white IP20 22W/2G13 HF D500 mm	905,31
7740101HF-F	BLOOM pendant lamp white IP20 22W/2G13 HF-F D500 mm	976,65
7740107	BLOOM pendant lamp red IP20 22W/2G13 HF D500 mm	905,31
7740107HF-F	BLOOM pendant lamp red IP20 22W/2G13 HF-F D500 mm	976,65
7740114	BLOOM pendant lamp yellow IP20 22W/2G13 HF D500 mm	905,31
7740114HF-F	BLOOM pendant lamp yellow IP20 22W/2G13 HF-F D500 mm	976,65
7741101	BLOOM pendant lamp white IP20 75W/E27 D500 mm	783,66
7741107	BLOOM pendant lamp red IP20 75W/E27 D500 mm	783,66
7741114	BLOOM pendant lamp yellow IP20 75W/E27 D500 mm	783,66
7742101	BLOOM pendant D500 HF white IP20 LED/1800LM/15,3W/3000K	897,75
7742101HF-F	BLOOM pendant D500 HFF white IP20 LED/1800LM/15,3W/3000K	986,87
7742106	BLOOM pendant D500 HF black IP20 LED/1800LM/15,3W/3000K	897,75
7742106HF-F	BLOOM pendant D500 HFF black IP20 LED/1800LM/15,3W/3000K	986,87
7742107	BLOOM pendant lamp red IP20 LED/1800LM/15,3W/3000K	897,75
7742107HF-F	BLOOM pendant lamp red IP20 LED/1800LM/15,3W/3000K	986,87
7742114	BLOOM pendant D500 HF yellow IP20 LED/1800LM/15,3W/3000K	897,75
7742114HF-F	BLOOM pendant D500 HFF yello IP20 LED/1800LM/15,3W/3000K	986,87

HFF = Dimmable with SwitchDIM, DSI or DALI. 1-10V on request.

WOOD

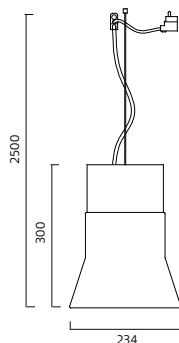

Finish: Oiled or black stained oak veneer and matt opal glass. Available in other wood finishes and stains on request.

Installation: Ceiling.

Connection: Terminal block 3x2,25mm² when HFF cable without plug.

Design: Fredrik Mattson 2010.

ART	DESCRIPTION	PRICE/EUR
8020132	WOOD pendant lamp oiled oak IP20 26-32W/Gx24q HF H310 D240	548,80
8020132HF-F	WOOD pendant lamp oiled oak IP20 32W/Gx24q HFF H310 D240	601,81
8020136	WOOD pendant lamp black oak IP20 26-32W/Gx24q HF H310 D240	548,80
8020136HF-F	WOOD pendant lamp black oak IP20 32W/Gx24q HFF H310 D240	601,81

HFF = Dimmable with SwitchDIM, DSI or DALI. 1-10V on request.



BOTTLE

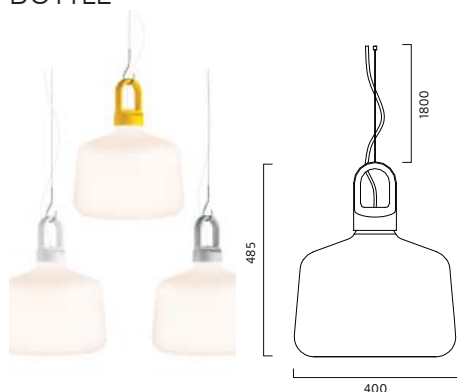

Finish: Cast aluminium and matt opal UV-stable polyethene..

Installation: Ceiling-hook.

Connection: Terminal block 3x4mm².

Design: Mattias Ståhlbom 2009.

ART	DESCRIPTION	PRICE/EUR
77730101	BOTTLE pendant lamp white IP20 18W/Gx24q-2 HF H485 D400	514,64
7730114	BOTTLE pendant lamp yellow IP20 18W/Gx24q-2 HF H485 D400	514,64
7730185	BOTTLE pendant lamp aluminium IP20 18W/Gx24q-2 HF H485 D400	514,64
7732101	BOTTLE pendant lamp white IP20 60W/E27 H485 D400	467,86
7732114	BOTTLE pendant lamp yellow IP20 60W/E27 H485 D400	467,86
7732185	BOTTLE pendant lamp alum IP20 60W/E27 H485 D400	467,86

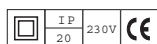

TOP

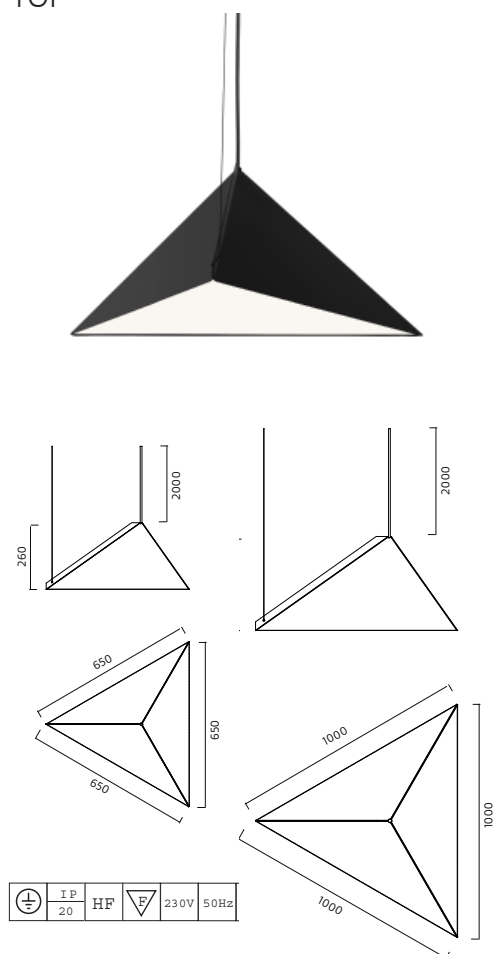

Finish: White or black painted metal. Diffuser in matt acrylic. The angle of the shade can be adjusted with a wire.

Installation: Ceiling hook.

Connection: Terminal block 3x4mm². when HFF 5x4mm²

Design: Tham & Videgård 2009.

ART	DESCRIPTION	PRICE/EUR
7850101	TOP pendant lamp white IP20 22W/2G13 HF 650 mm	677,23
7850101HF-F	TOP pendant lamp white IP20 22W/2G13 HF-F 650 mm	777,81
7850106	TOP pendant lamp black IP20 22W/2G13 HF 650 mm	677,23
7850106HF-F	TOP pendant lamp black IP20 22W/2G13 HF-F 650 mm	777,81
7850301	TOP pendant lamp white IP20 40W/2GX13+26-42W/Gx24q	1 317,01
7850301HF-F	TOP pendant lamp white IP20 40W/2GX13+42W/Gx24q HF	1 452,70
7850306	TOP pendant lamp black IP20 40W/2GX13+26-42W/Gx24q	1 317,01
7850306HF-F	TOP pendant lamp black IP20 40W/2GX13+42W/Gx24q HF	1 452,70
7852101	TOP pendant lamp white IP20 60W/E27 650 mm	631,61
7852106	TOP pendant lamp black IP20 60W/E27 650 mm	631,61
7852301	TOP pendant lamp white IP20 60W/E27 1000 mm	1 029,29
7852306	TOP pendant lamp black IP20 60W/E27 1000 mm	1 029,29
7857101	TOP pendant D650 HF white IP20 LED/1800LM/15,3W/3000K	670,82
7857101HF-F	TOP pendant D650 HFF white IP20 LED/1800LM/15,3W/3000K	759,93
7857106	TOP pendant D650 HF black IP20 LED/1800LM/15,3W/3000K	670,82
7857106HF-F	TOP pendant D650 HFF black IP20 LED/1800LM/15,3W/3000K	759,93
7857301	TOP pendant D1000 HF white IP20 LED/1800LM/15,3W/3000K	1 156,39
7857301HF-F	TOP pendant D1000 HFF white IP20 LED/1800LM/15,3W/3000K	1 245,51
7857306	TOP pendant D1000 HF black IP20 LED/1800LM/15,3W/3000K	1 156,39
7857306HF-F	TOP pendant D1000 HFF black IP20 LED/1800LM/15,3W/3000K	1 245,51

HFF = Dimmable with SwitchDIM, DSI or DALI. 1-10V on request.

TOP



Finish: White or black painted metal. Diffuser in matt acrylic. L1600 mm

Installation: Ceiling, wire pendant.

Connection: With cable and plug, when HFF without plug.

Design: Tham & Videgård 2009.

ART	DESCRIPTION	PRICE/EUR
7855301	TOP pendant lamp white IP20 35/49W/T5 L1600 mm	655,00
7855301HF-F	TOP pendant lamp white IP20 35/49W/T5 L1600 mm	708,21
7855306	TOP pendant lamp black IP20 35/49W/T5 L1600 mm	655,00
7855306HF-F	TOP pendant lamp black IP20 35/49W/T5 HFF L1600 mm	708,21

HFF = Dimmable with SwitchDIM, DSI or DALI. 1-10V on request.

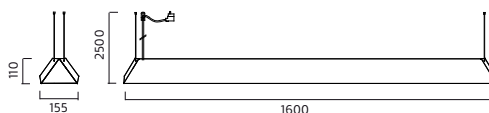

RGB

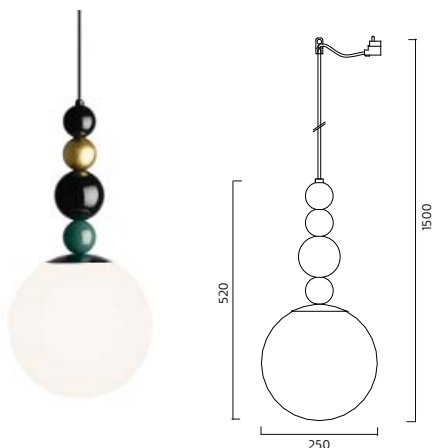

Finish: Glossy painted wooden balls. Multi colour - black, green and gold or all balls in black.

Installation: Ceiling hook. Incl. separate ceiling-cup.

Connection: Terminal block 2x2,5mm².

Design: Fredrik Mattson 2008.

ART	DESCRIPTION		PRICE/EUR
7778106	RGB pendant lamp black	IP20 60W/E27	528,68
7778190	RGB pendant lamp multicolour	IP20 60W/E27	673,71

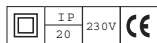

CAMOUFLAGE 800



Finish: Laser-cut aluminium, painted white, other colors on request.

Installation: Ceiling. Pendant tube or wire pendant. Special lengths on request.

Connection: Terminal block 5x4mm².

Design: Front, 2007.

ART	DESCRIPTION	PRICE/EUR
7830101	CAMOUFLAGE pendant tube white IP20 250W/B15d D800 mm	2 455,89
7831101	CAMOUFLAGE wire pendant white IP20 250W/B15d D800 mm	2 455,89
7835101	CAMOUFLAGE wire pendant white IP20 35W/ME/E27 D800 mm	2 759,19
7836101	CAMOUFLAGE wire pendant white IP20 100W/E27 D800 mm	2 526,43

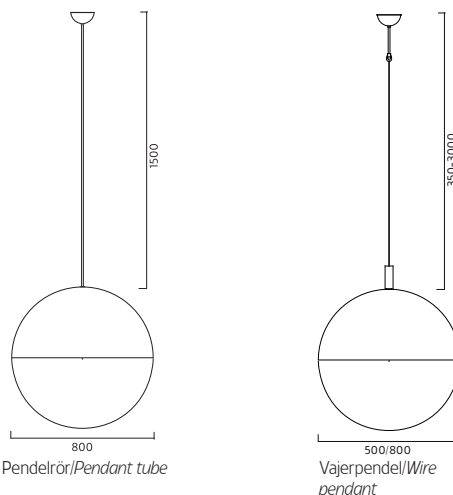

CAMOUFLAGE 500



Finish: Laser-cut aluminium, painted white, other colors on request.

Installation: Ceiling. Pendant tube or wire pendant. Special lengths on request.

Connection: Terminal block 5x4mm².

Design: Front, 2007.

ART	DESCRIPTION	PRICE/EUR
7832101	CAMOUFLAGE pendant tube white IP20 150WB15d D500 mm	1 403,57
7833101	CAMOUFLAGE wire pendant white IP20 150WB15d D500 mm	1 487,78
837101	CAMOUFLAGE wire pendant white IP20 E27/100W D500 mm	1 487,78
7838101	CAMOUFLAGE wire pendant white IP20 35W/ME/E27 D500 mm	1 609,43

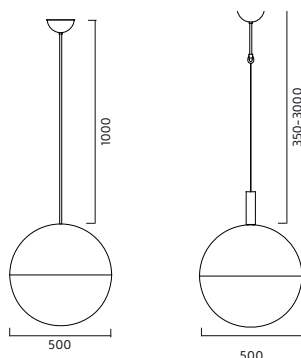

POKER



Finish: Aluminium, painted white or black. Other colours on request. Diffuser in matt acrylic.

Installation: Wire and cable pendant, 2 m, other lengths on request.

Connection: Terminal block 3x2,5mm², when HFF terminal block 5x4mm².

Design: Thomas Bernstrand 2007

ART	DESCRIPTION		PRICE/EUR
7800101	POKER pendant fix. white shade	IP20 22W/2Gx13 HF D480 mm	489,44
7800101HF-F	POKER pendant fix. white shade	IP20 22W/2Gx13 HFF D480 mm	607,18
7800106	POKER pendant fix. black shade	IP20 22W/2Gx13 HF D480 mm	489,44
7800106HF-F	POKER pendant fix. black shade	IP20 22W/2Gx13 HFF D480 mm	607,18
7800301	POKER pendant fix. white shade	IP20 4x26-42W/Gx24q HF D1040	1 948,95
7800301HF-F	POKER pendant fix. white shade	IP20 4x42W/Gx24q HFF D1040	2 235,39
7800306	POKER pendant fix. black shade	IP20 4x26-42W/Gx24q HF D1040	1 948,95
7800306HF-F	POKER pendant fix. black shade	IP20 4x42W/Gx24q HFF D1040 mm	2 235,39
7801101	POKER pendant fixture white sh	IP20 75W/E27 D480 mm	445,12
7801106	POKER pendant fix. black shade	IP20 75W/E27 D480 mm	445,12
7801301	POKER pendant fix. white shade	IP20 75W/E27 D1040 mm	1 810,52
7801306	POKER pendant fix. black shade	IP20 75W/E27 D1040 mm	1 810,52
7804101	POKER pendant D480 HF white	IP20 LED/1800LM/15,3W/3000K	612,64
7804101HF-F	POKER pendant D480 HFF white	IP20 LED/1800LM/15,3W/3000K	701,75
7804106	POKER pendant D480 HF black	IP20 LED/1800LM/15,3W/3000K	612,64
7804106HF-F	POKER pendant D480 HFF black	IP20 LED/1800LM/15,3W/3000K	701,75
7804301	POKER pendant D1040 HF white	IP20 LED/1800LM/15,3W/3000K	1 838,96
7804301HF-F	POKER pendant D1040 HFF whit	IP20 LED/1800LM/15,3W/3000K	1 928,08
7804306	POKER pendant D1040 HF black	IP20 LED/1800LM/15,3W/3000K	1 838,96
7804306HF-F	POKER pendant D1040 HFF black	IP20 LED/1800LM/15,3W/3000K	1 928,08

HFF = Dimmable with SwitchDIM, DSI or DALI. 1-10V on request.

LAST



Finish: Aluminium, painted white or black. Other colours on request.

Installation: Ceiling-installation, 2 m cable.

Connection: Terminal block 3x2,5mm², when HFF terminal block 5x4mm².

Design: Mattias Ståhlbom, 2007.

ART	DESCRIPTION		PRICE/EUR
7780101	LAST pendant fixture white	IP20 26-42W/Gx24q HF D420 mm	595,05
7780101HF-F	LAST pendant fixture white	IP20 26-42W/Gx24q HFF D420 mm	703,47
7780106	LAST pendant fixture black	IP20 26-42W/Gx24q HF D420 mm	595,05
7780106HF-F	LAST pendant fixture black	IP20 26-42W/Gx24q HFF D420 mm	703,47
7782101	LAST pendant lamp white	IP20 75W/E27 D420 mm	524,20
7782106	LAST pendant lamp black	IP20 75W/E27 D420 mm	524,20

HFF = Dimmable with SwitchDIM, DSI or DALI. 1-10V on request.



PXL



Finish: Aluminium and steel, multicolour alt. white.

Installation: On ceiling, 2 m cable. Other lengths on request.

Connection: Terminal block 2x2,5mm².

Design: Fredrik Mattson 2007.

ART	DESCRIPTION		PRICE/EUR
7770101	PXL pendant fixture white	IP20 E27/60W D320 mm	803,68
7770190	PXL pendant fixture multi	IP20 E27/60W D320 mm	803,68

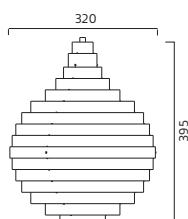

PXL

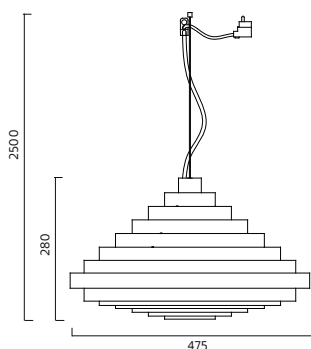

Finish: Painted aluminum and metal. Wire pendant.

Installation: Ceiling.

Connection: Terminal block 5x4mm².

Design: Fredrik Mattson 2010.

ART	DESCRIPTION		PRICE/EUR
7770301	PXL pendant fixture white	IP20 E27/75W D500 mm	1 116,54
7770390	PXL pendant fixture multi	IP20 E27/75W D500 mm	1 116,54
7770501	PXL pendant fixture white	IP20 40W/2Gx13 HF D500 mm	1 262,28
7770501HF-F	PXL pendant fixture white	IP20 40W/2Gx13 HFF D500 mm	1 379,58
7770590	PXL pendant fixture multi	IP20 40W/2Gx13 HF D500 mm	1 262,28
7770590HF-F	PXL pendant fixture multi	IP20 40W/2Gx13 HFF D500 mm	1 379,58
7770701	PXL pendant fixture white	IP20 55W/2Gx13 HF D500 mm	1 262,28
7770701HF-F	PXL pendant fixture white	IP20 55W/2Gx13 HFF D500 mm	1 379,58
7770790	PXL pendant fixture multi	IP20 55W/2Gx13 HF D500 mm	1 262,28
7770790HF-F	PXL pendant fixture multi	IP20 55W/2Gx13 HFF D500 mm	1 379,58

HFF = Dimmable with SwitchDIM, DSI or DALI. 1-10V on request.



HIDE

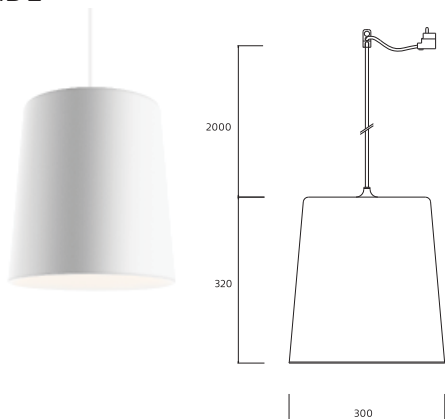

Finish: White-, black- or yellow (Ral1016) painted aluminium. Inside of opal acrylic, open when reflector. Available with LED Philips Fortimo 2000 lumen.

Installation: Ceiling-hook, 2 m white cable when black shade black cable.

Connection: Terminal block 3x4mm². HFF with terminal block 5x4mm²

Design: Thomas Bernstrand 2007

ART	DESCRIPTION		PRICE/EUR
7380101	HIDE pendant fixture D300 whit	IP20 26-42W/Gx24q-3 HF	442,71
7380101HF-F	HIDE pendant fixture D300 whit	IP20 42W/Gx24q-3 HFF	492,03
7380106	HIDE pendant fixture D300 blac	IP20 26-42W/Gx24q-3 HF	442,71
7380106HF-F	HIDE pendant fixture D300 blac	IP20 42W/Gx24q-3 HFF	492,03
7380114	HIDE pendant fixture D300 yell	IP20 26-42W/Gx24q-3 HF	442,71
7380114HF-F	HIDE pendant fixture D300 yell	IP20 42W/Gx24q-3 HFF	492,03
7381101	HIDE pendant with refl. white	IP20 26-42W/Gx24q-3 HF D300 mm	548,08
7381101HF-F	HIDE pendant with refl. white	IP20 42W/Gx24q HFF D300 mm	590,27
7381106	HIDE pendant with refl. black	IP20 26-42W/Gx24q-3 HF D300 mm	548,08
7381106HF-F	HIDE pendant with refl. black	IP20 42W/Gx24q HFF D300 mm	590,27
7381114	HIDE pendant with refl. yellow	IP20 26-42W/Gx24q-3 HF D300 mm	548,08
7381114HF-F	HIDE pendant with refl. yellow	IP20 42W/Gx24q HFF D300 mm	590,27
7386101	HIDE pendant fixture D300 whit	IP20 E27/75W 2 m cable	347,01
7386106	HIDE pendant fixture D300 blac	IP20 E27/75W 2 m cable	347,01
7386114	HIDE pendant fixture D300 yell	IP20 E27/75W 2 m cable	347,01
7388101	HIDE pendant lamp white	IP20 LED/2000Lm/830 D300 mm	1 094,79
7388106	HIDE pendant lamp black	IP20 LED/2000Lm/830 D300 mm	1 094,79
7388114	HIDE pendant lamp yellow	IP20 LED/2000Lm/830 D300 mm	1 094,79

HFF = Dimmable with SwitchDIM, DSI or DALI. 1-10V on request.

HIDE

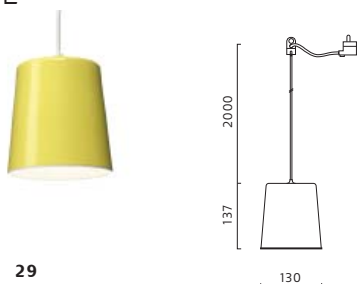

Finish: White-, black- or yellow (Ral1016) painted aluminium. Inside of opal acrylic.

Installation: On ceiling-hook, 2 m cable.

Connection: Terminal block 2x2,5mm².

Design: Thomas Bernstrand 2007.

ART	DESCRIPTION		PRICE/EUR
7489101	HIDE pendant fixture D130 white	IP20 35W/GU10	210,54
7489106	HIDE pendant fixture D130 blac	IP20 35W/GU10	210,54
7489114	HIDE pendant fix. D130 yellow	IP20 35W/GU10	210,54



HIDE



Finish: Closed shade in Matt opal glass.
Installation: on ceiling, cable and wire pendant.
Connection: Terminal block 3x4mm² when HFF 5x4mm².
Design: Thomas Bernstrand 2007.

ART	DESCRIPTION		PRICE/EUR
7380121	HIDE pendant fixture glass	IP20 26-42W/Gx24q-3 HF D300	480,90
7380121HF-F	HIDE pendant fixture glass	IP20 26-42W/Gx24q-3 HFF D300	530,02
7386121	HIDE pendant fixture glass	IP20 E27/75W D300 2 m cable	390,73

HFF = Dimmable with SwitchDIM, DSI or DALI. 1-10V on request.



CAN

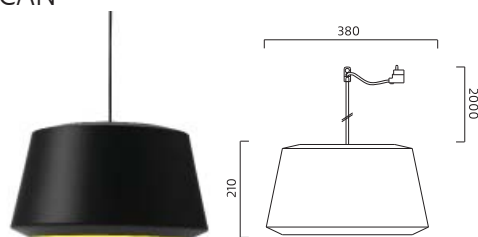

Finish: White or black painted aluminium with yellow coloured inside. White is also available with white inside.
Installation: Ceiling-hook, 2 m cable.
Connection: Terminal block 2x2,5mm².
Design: Mattias Ståhlbom 2007

ART	DESCRIPTION		PRICE/EUR
7510101	CAN pendant fix. D380 whi/yell	IP20 75W/E27	421,60
7510106	CAN pendant fix. D380 black/ye	IP20 75W/E27	421,60



THREE

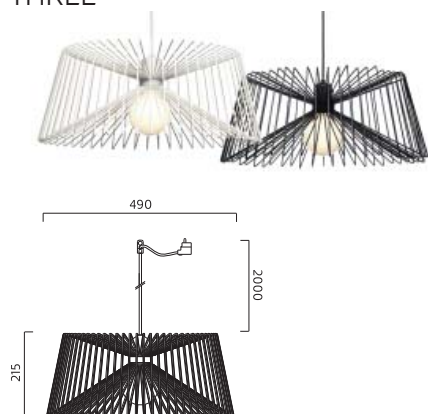

Finish: White or black painted steel wire. Other colours on request.
Installation: On ceiling-hook.
Connection: Terminal block 2x2,5mm².
Design: Mattias Ståhlbom 2007

ART	DESCRIPTION		PRICE/EUR
7436101	THREE pendant fixture white	IP20 60W/E27 D490 mm	355,84
7436106	THREE pendant fixture black	IP20 60W/E27 D490 mm	355,84



W-IN



Finish: Transparent acrylic. Black painted inside. Aluminium reflector.
Installation: 1,7 m wire pendant.
Connection: 2,5 m cable with plug, when HFF without plug.
Design: Wingårdhs Arkitekter, 2006.

ART	DESCRIPTION		PRICE/EUR
7670118	W-IN pendant fix. acryl transp	IP20 70W/G12 HF D524 mm	1 365,45
7672118	W-IN pendant fix. acrylic tran	IP20 26-42W/Gx24q HF D524 mm	1 184,51
7672118HF-F	W-IN pendant fix. acrylic tran	IP20 42W/Gx24q HFF D524 mm	1 218,70
7673118	W-IN pendant fix. acrylic tran	IP20 150W/E27 D524 mm	1 261,22



ARCAD

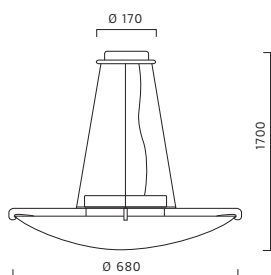

Finish: Dark grey painted steel. Shade in matt opal glass or matt acrylic.

Installation: Ceiling, wire pendant.

Connection: Snap-in terminal block 5x4mm². Two entry holes and knockout for external mains cable.

ART	DESCRIPTION		PRICE/EUR
4042321HF	ARCAD pendant fixture glass	IP20 4x18W/Gx24q-2 D680 mm	1 180,94
4042321HF-F	ARCAD pendant fixture glass	IP20 4x18W/Gx24q-2 D680mm	1 365,88
4042327HF	ARCAD pendant fixture acrylic	IP20 4x18W/Gx24q-2 D680 mm	1 033,26
4042327HF-F	ARCAD pendant fixture acrylic	IP20 4x18W/Gx24q-2 D680mm	1 218,70
4044321	ARCAD pendant fixture glass	IP20 4x75W/E27 D680 mm	915,62
4044327	ARCAD pendant fixture acrylic	IP20 4x75W/E27 D680 mm	767,93
4045321HF	ARCAD pendant fixture glass	IP20 26-42W/Gx24q D680mm	1 210,58
4045321HF-F	ARCAD pendant fixture glass	IP20 4x32W/Gx24q-3 HFF D680	1 395,15
4045327HF	ARCAD pendant fixture acrylic	IP20 4x26-42w/Gx24q D680mm	1 075,63
4045327HF-F	ARCAD pendant fixture acrylic	IP20 4x32W/Gx24q-3 HFF D680	1 261,13
4046321HF-F	ARCAD pendant fixture glass	IP20 4x42W/Gx24q-3 HFF D680	1 380,41

HFF = Dimmable with SwitchDIM, DSI or DALI. 1-10V on request.



CLAM

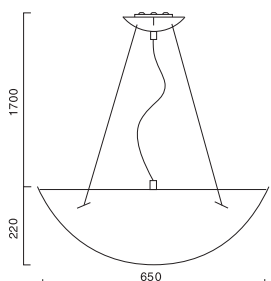

Finish: Zinc painted steel and matt opal acrylic.

Installation: Ceiling, 1,7m wire, longer lengths on request.

Connection: Snap-in terminal block 5x4mm². Two entry holes.

Design: pelikan copenhagen.

ART	DESCRIPTION		PRICE/EUR
7540327	CLAM pendant/N D650 dull acryl	IP20 4x26-42W/Gx24q HF	795,31
7540327HF-F	CLAM pendant/N D650 dull acryl	IP20 4x42W/Gx24q HFF	899,22

HFF = Dimmable with SwitchDIM, DSI or DALI. 1-10V on request.



ALLRIGHT

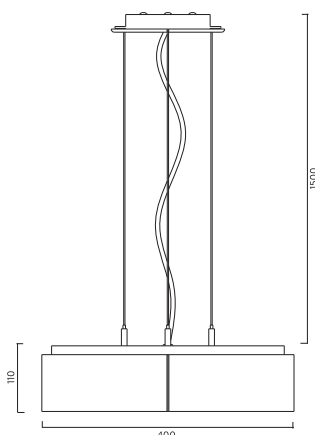

Finish: Anodized aluminium, natural, bronze or dark grey painted and white painted steel.

Diffuser in prismatic acrylic.

Installation: Ceiling-installation, 1,7 m wire.

Connection: Terminal-block 5x4mm². Two entry holes.

Design: Per Sundstedt.

ART	DESCRIPTION		PRICE/EUR
7410338	ALLRIGHT pendant fixture alu	IP20 40W/2Gx13 D400 mm	705,30
7410338HF-F	ALLRIGHT fixture pendant alu	IP20 40W/2Gx13 HFF D400 mm	745,72
7410397	ALLRIGHT pendants bronze	IP20 40W/2Gx13 HF D400	733,52
7410397HF-F	ALLRIGHT pendants bronze	IP20 40W/2Gx13 HFF D400	773,94
7410398	ALLRIGHT pendants grey	IP20 40W/2Gx13 HF D400	733,52
7410398HF-F	ALLRIGHT pendants grey	IP20 40W/2Gx13 HFF D400	773,94
7411338	ALLRIGHT pendant fixture alu	IP20 55W/2Gx13 D400 mm	705,30
7411338HF-F	ALLRIGHT fixture pendant alu	IP20 55W/2Gx13 D400 mm	745,72
7411397	ALLRIGHT pendants bronze	IP20 55W/2Gx13 HF D400	733,52
7411397HF-F	ALLRIGHT pendants bronze	IP20 55W/2Gx13 HFF D400	773,94
7411398	ALLRIGHT pendants grey	IP20 55W/2Gx13 HF D400	733,52
7411398HF-F	ALLRIGHT pendants grey	IP20 55W/2Gx13 HFF D400	773,94
7428338	ALLRIGHT pendant D400 HF alu	IP20 LED/1800LM/15,3W/3000K	665,48
7428338HF-F	ALLRIGHT pendant D400 HFF alu	IP20 LED/1800LM/15,3W/3000K	754,60
7428397	ALLRIGHT pendants D400 bronze	IP20 LED/1800LM/15,3W/3000K	693,70
7428397HF-F	ALLRIGHT pendants D400 bronze	IP20 LED/1800LM/15,3W/3000K	782,82
7428398	ALLRIGHT pendants D400 grey	IP20 LED/1800LM/15,3W/3000K	693,70
7428398HF-F	ALLRIGHT pendants D400 grey	IP20 LED/1800LM/15,3W/3000K	782,82

HFF = Dimmable with SwitchDIM, DSI or DALI. 1-10V on request.



MIMMI

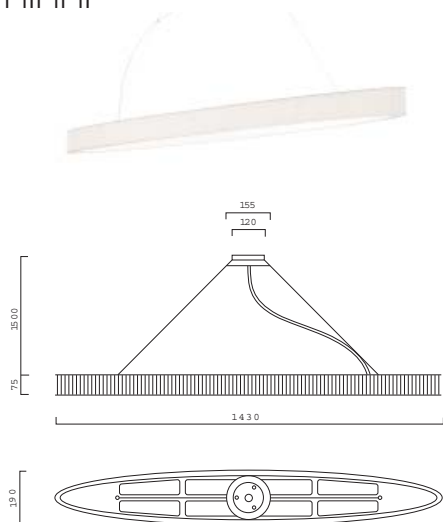

Finish: Grey painted steel. White pleated shade. Louvre in opal acrylic.

Installation: Wire pendant.

Connection: Snap-in terminal block 3x4mm². Two entry holes.

Design: pelikan copenhagen.

ART	DESCRIPTION	PRICE/EUR
4401335	MIMMI pendant fixture white IP20 2x28W/T5 HF L1430	774,17
4401335HF-F	MIMMI pendant fixture white IP20 2x28W/T5 HFF L1430 mm	858,31

HFF = Dimmable with SwitchDIM, DSI or DALI. 1-10V on request.



MIMMI

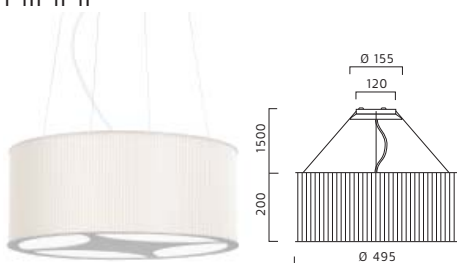

Finish: Grey painted steel. White pleated shade. Louvre in opal acrylic.

Installation: Wire pendant.

Connection: Snap-in terminal block 3x4mm². Two entry holes.

Design: pelikan copenhagen.

ART	DESCRIPTION	PRICE/EUR
4406135	MIMMI pendant fixture white IP20 4x75W/E27 D495 H200	550,15
4407135	MIMMI pendant fixture white IP20 4x26-42W/Gx24q-3 HF D495	710,83
4407135HF-F	MIMMI pendant fixture white IP20 4x42W/Gx24q-3 HFF D495	898,78
4408135	Mimmi pendant fixture white IP20 4x32W/Gx24q-3 D495mm	725,32
4408135HF-F	MIMMI pendant fixture white IP20 4x32W/Gx24q-3 HFF D495	898,78
4417135HF-F	MIMMI pendant fixture white IP20 4x42W/Gx24q-4 HFF D495	898,78

HFF = Dimmable with SwitchDIM, DSI or DALI. 1-10V on request.



MIMMI

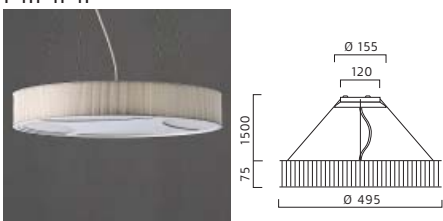

Finish: Grey painted steel. White pleated shade. Opal acrylic.

Installation: Wire pendant.

Connection: Snap-in terminal block 3x4mm². Two entry holes.

Design: pelikan copenhagen.

ART	DESCRIPTION	PRICE/EUR
4409135	MIMMI pendant fixture IP20 4x26-32W/Gx24q-3 HF D495	698,31
4409135HF-F	Mimmi pendant fixture white IP20 4x26W/Gx24q HFF D495	886,41
4411135HF-F	MIMMI pendant fixture white IP20 4x32W/Gx24q-3 HFF D495 mm	886,41

HFF = Dimmable with SwitchDIM, DSI or DALI. 1-10V on request.



MIMMI



Finish: Grey painted steel. White pleated shade. Louvre in opal acrylic. Compact flourscent in the shade and downlight with compact flourescent or E27/PAR38.

Installation: Wire pendant.

Connection: Snap-in terminal block 3x4mm². Two entry holes.

Design: pelikan copenhagen.

ART	DESCRIPTION	PRICE/EUR
4413135	Mimmi pendant fixture white IP20 4x26-42W/Gx24q+2x18W	1 145,09
4413135HF-F	Mimmi pendant fixture white IP20 4x32W/Gx24q+2x18W/Gx24q	1 425,61
4416135HF-F	MIMMI pendant fixture D450mm 4x42W/Gx24q-4+2x18W/G24q-2	1 425,61

HFF = Dimmable with SwitchDIM, DSI or DALI. 1-10V on request.

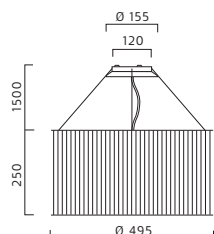

MIMMI

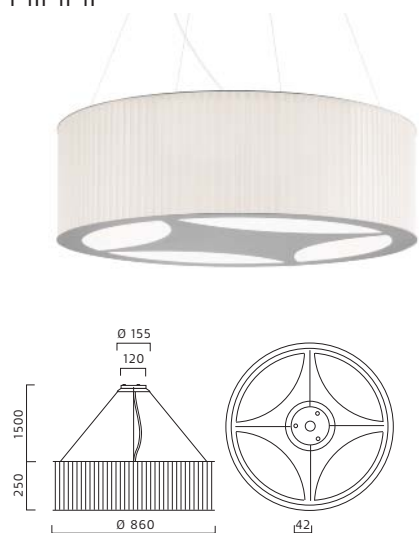

Finish: Grey painted steel. White pleated shade. Louvre in opal acrylic.

Installation: Wire pendant.

Connection: Snap-in terminal block 3x4mm². Two entry holes.

Design: pelikan copenhagen.

ART	DESCRIPTION	PRICE/EUR
4433135	MIMMI pendant fixture white IP20 8x26-42W/Gx24q-3 HF H250	1 591,41
4433135HF-F	MIMMI pendant fixture white IP20 8x26-42W/Gx24q-3 HFF H250	2 111,19
4434135	MIMMI pendant fixture IP20 8x32W/Gx24q-3 H250 D860	1 621,21
4434135HF-F	MIMMI pendant fixture IP20 8x32W/Gx24q-3 HFF H250mm	2 111,19
4435135HF-F	MIMMI pendant fixture IP20 8x42W/Gx24q-4 HFF H250mm	2 111,19

HFF = Dimmable with SwitchDIM, DSI or DALI. 1-10V on request.



PUKEBERG ORIGINAL

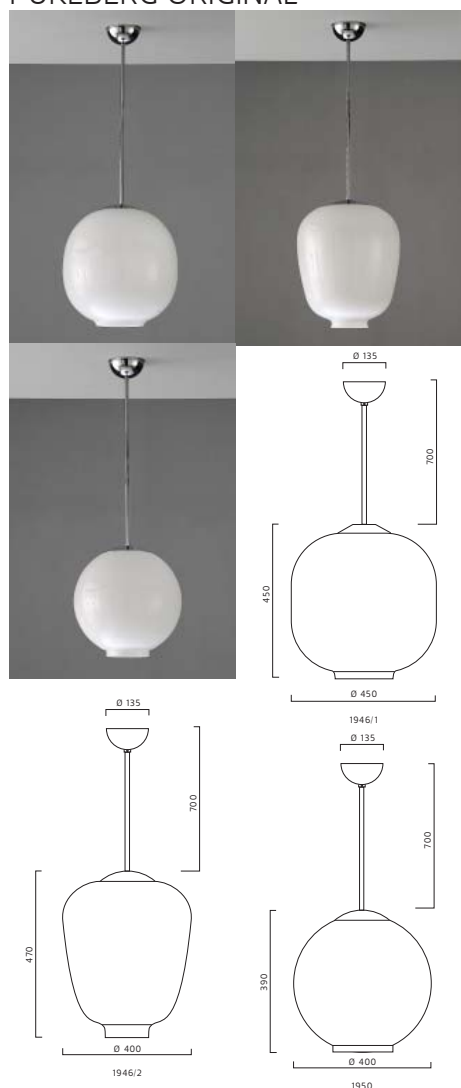

Pukeberg Original are made in original glass moulds from Pukeberg Glassworks.

Finish: Chromed pendant. Shade in opal glass.

Installation: Ceiling-hook.

Connection: Snap-in terminal block 5x4mm².

ART	DESCRIPTION	PRICE/EUR
5082182	PUKEBERG ORIGINAL 1946/1 IP20 200W/E27 H450 mm	537,61
5083182	PUKEBERG ORIGINAL 1946/2 IP20 200W/E27 H470 mm	621,74
5084182	PUKEBERG ORIGINAL 1950 IP20 200W/E27 H390 mm	537,61
5282182	PUKEBERG ORIGINAL 1946/1 IP20 2x26-32W/Gx24q-3 HF	621,95
5282182HF-F	PUKEBERG ORIGINAL 1946/1 IP20 2x32W/Gx24q-3 HFF H450	699,74
5283182	PUKEBERG ORIGINAL 1946/2 IP20 2x26-32W/Gx24q-3 HF	589,72
5283182HF-F	PUKEBERG ORIGINAL 1946/2 IP20 2x32W/Gx24q-3 HFF H470	731,77
5284182	PUKEBERG ORIGINAL 1950 IP20 2x26-32W/Gx24q-3 HF D390	548,05
5284182HF-F	PUKEBERG ORIGINAL 1950 IP20 2x32W/Gx24q-3 HFF H390	628,02
5382182	PUKEBERG ORIGINAL 1946/1 IP20 3x26-32W/Gx24q-3 HF D450	669,26
5382182HF-F	PUKEBERG ORIGINAL 1946/1 IP20 3x32W/Gx24q-3 HFF D450	825,50
5383182	PUKEBERG ORIGINAL 1946/2 IP20 3x26-32W/Gx24q-3 HF D470	637,04
5383182HF-F	PUKEBERG ORIGINAL 1946/2 IP20 3x32W/Gx24q-3 HFF D470 mm	794,05
5384182	PUKEBERG ORIGINAL 1950 IP20 3x26-32W/Gx24q-3 HF D390	595,36
5384182HF-F	PUKEBERG ORIGINAL 1950 IP20 3x32W/Gx24q-3 HFF D390	753,57

HFF = Dimmable with SwitchDIM, DSI or DALI. 1-10V on request.



KULAN

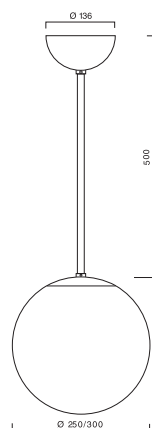
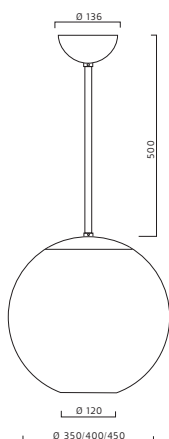

Finish: Chromed pendant. Shade in opal glass. D250-300 mm are closed D350-450 mm are open.

Installation: Ceiling-hook.

Connection: Terminal block 3x4mm².

ART	DESCRIPTION	PRICE/EUR
5270220	KULAN pendant fixture D250 opa IP20 100W/E27 closed globe	173,96
5270320	KULAN pendant fixture D300 opa IP20 100W/E27 closed globe	188,00
5270420	KULAN pendant fixture D350 mm IP20 150W/E27 open globe	241,37
5270520	KULAN pendant fixture D400 opa IP20 150W/E27 open globe	342,49
5270620	KULAN pendant fixture D450 opa IP20 150W/E27 open globe	420,23
5373420	KULAN pendant fixture D350 opa IP20 1x26-32W/Gx24q-3 HF o globe	403,16
5373520	KULAN pendant fixture D400 opa IP20 26-32W/Gx24q-3 HF o globe	546,97
5373620	KULAN pendant fixture D450 opa IP20 26-32W/Gx24q-3 HF o globe	602,07
5373620HF-F	KULAN pendant fixture D450 opa IP20 32W/Gx24q-3 HFF op globe	663,59
5374420	KULAN pendant fixture D350 opa 2x26-32W/Gx24q-3 HF op globe	417,72
5374420HF-F	KULAN pendant fixture D350 opa 2x32W/Gx24q-3 HFF op globe	501,67
5374520	KULAN pendant fixture D400 opa 2x26-32W/Gx24q-3 HF open globe	561,49
5374520HF-F	KULAN pendant fixture D400 opa 2x32W/Gx24q-3 HFF open globe	640,78
5374620	KULAN pendant fixture D450 opa 2x26-32W/Gx24q-3 HF open globe	616,58
5374620HF-f	KULAN pendant fixture D450 opa 2x32W/Gx24q-3 HFF open globe	694,62
5375720	KULAN pendant fixture D450 opa 3x26-32W/Gx24q-3 HF open globe	663,91
5375720HF-F	KULAN pendant fixture D450 opa 3x32W/Gx24q-3 HFF open globe	820,18

HFF = Dimmable with SwitchDIM, DSI or DALI. 1-10V on request.



PS 2

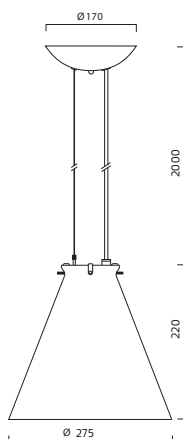

Finish: White painted and chromed steel. Shade in matt opal glass. Wire pendant.

Installation: Ceiling.

Connection: Terminal block 3x4mm².

Design: Per Sundstedt.

ART	DESCRIPTION	PRICE/EUR
4010101	PS2 pendant fixture white IP20 75W/E27 D275 mm	342,66
4020101	PS 2 pendant fixture glass IP20 13W/Gx24q-1 HF D275 mm	449,40
4020201	PS 2 pendant fixture white IP20 18W/Gx24q-2 HF D275 mm	449,40



PS 5

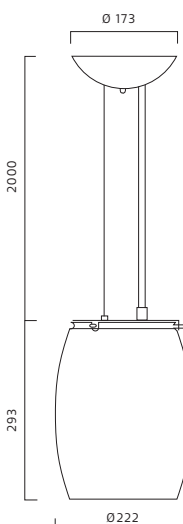

Finish: White painted and chromed steel. Shade in matt opalglass. Metalized reflector available as accessory.

Installation: Ceiling.

Connection: Snap-in terminal block 5x4mm².

Design: Per Sundstedt.

ART	DESCRIPTION	PRICE/EUR
4017121	PS5 pendant fixture white IP20 75W/E27	460,89
4027121	PS5 pendant fixture glass IP20 26-42W/Gx24q HF D222 mm	494,56
4027121HF-F	PS 5 pendant fixture glass IP20 42W/Gx24q-4 HFF H293 mm	559,43

HFF = Dimmable with SwitchDIM, DSI or DALI. 1-10V on request.

ACCESSORIES

95186101	PS5/PS6 reflector	52,26
----------	-------------------	-------



PS 6

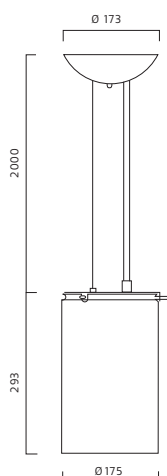

Finish: White painted and chromed steel. Shade in matt opalglass. Aluminium reflector available as accessory.

Installation: Ceiling.

Connection: Snap-in terminal block 5x4mm².

Design: Per Sundstedt.

ART	DESCRIPTION		PRICE/EUR
4018121	PS6 pendant fixture white	IP20 75W/E27	436,65
4028121	PS6 pendant fixture glass	IP20 26-42W/Gx24q HF	494,56
4028121HF-F	PS 6 pendant fixture glass	IP20 42W/Gx24q-4 HFF	559,43

HFF = Dimmable with SwitchDIM, DSI or DALI. 1-10V on request.

ACCESSORIES

95186101	PS5/PS6 reflector		52,26
----------	-------------------	--	-------



PS-KLOCKA

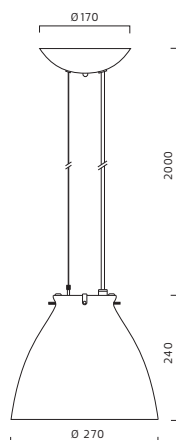

Finish: White painted and chromed steel. Shade in matt opal glass.. Wire pendant.

Installation: Ceiling.

Connection: Terminal block 3x4mm².

Design: Per Sundstedt.

ART	DESCRIPTION		PRICE/EUR
4014101	PS-KLOCKA pendant fixture	IP20 75W/E27 D270 mm	355,54
4024101	PS-KLOCKA pendant glass	IP20 13W//G24q-1 HF D 270 mm	436,31
4024301	PS-KLOCKA pendant glass	IP20 18W/Gx24q-2 HF D270 mm	436,31



GLOBUS

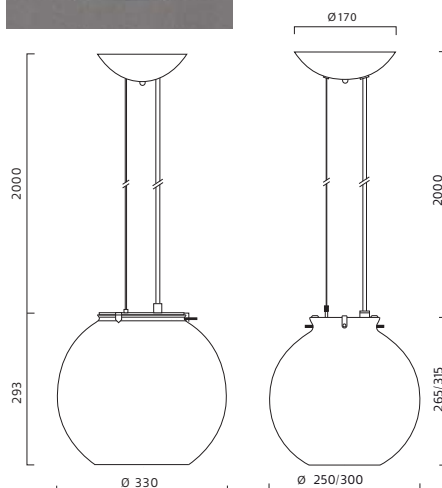

Finish: White painted and chromed steel. Shade in matt opal glass. Wire pendant. 4021-8 available with aluminium reflector.

Installation: Ceiling.

Connection: Snap-in terminal block 3x4mm². Two entry holes.

Design: Per Sundstedt.

ART	DESCRIPTION		PRICE/EUR
4011301	GLOBUS pendant fixture white	IP20 75W/E27 D250 open	305,81
4011501	GLOBUS pendant fixture white	IP20 75W/E27 D300 open	331,51
4021301	GLOBUS pendant fixture white	IP20 13W/G24q-1 HF D250 mm	430,97
4021401	GLOBUS pendant fixture white	IP20 18W/Gx24q-2 HF D250 mm	430,97
4021501	GLOBUS pendant fixture white	IP20 18W/Gx24q-2 HF D300 mm	457,16
4021801	GLOBUS pendant fixture white	IP20 26-42W/Gx24q-3 HF D330 mm	568,77
4021801HF-F	GLOBUS pendant fixture white	IP20 42W/Gx24q-3 HFF D330 mm	620,54

HFF = Dimmable with SwitchDIM, DSI or DALI. 1-10V on request.

ACCESSORIES

95186101	PS5/PS6 reflector, only possible with 4021-8		52,26
----------	--	--	-------



BANDY



Finish: White painted aluminium. Louvre in glass. Other colors on request. **Installation:** Wire pendant.

Connection: Ceiling plug, when HFF terminal block 5x4mm².

Design: Per Sundstedt.

ART	DESCRIPTION		PRICE/EUR
4510301	BANDY pendant lamps white	IP20 2x26-42W/Gx24q HF D425 mm	546,28
4510301HF-F	BANDY pendant lamps white	IP20 2x26-42W/Gx24q HFF D425	626,56
4510501	BANDY pendant lamps white	IP20 2x26-42W/Gx24q HF D540 mm	612,89
4510501HF-F	BANDY pendant lamps white	IP20 2x26-42W/Gx24q HFF D540	677,72
4511301	BANDY pendant lamps white	IP20 4x26-42W/G24xq HF D425 mm	623,13
4511301HF-F	BANDY pendant lamps white	IP20 4x42W/G24xq HFF D425 mm	783,61
4511501	BANDY pendant lamps white	IP20 4x26-42/G24xq HF D540 mm	674,31
4511501HF-F	BANDY pendant lamps white	IP20 4x42/G24xq HFF D540 mm	833,11

HFF = Dimmable with SwitchDIM, DSI or DALI. 1-10V on request.



VIVA SOLO

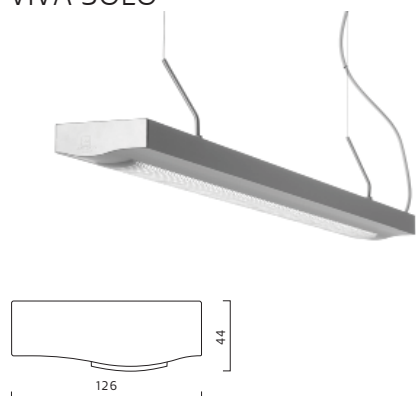

Finish: Anodized aluminium with rigid louvre. Acrylic dustcover on the top. Available with single or double pull-switch.

Installation: Wire pendant 1,7m with loop for ceiling hook.

Connection: Incl. 3 m cable and plug. When HFF 3 m 5-wired cable without plug.

Design: Per Sundstedt.

ART	DESCRIPTION		PRICE/EUR
77025338	VIVA Solo sym direct/indirect	IP20 2x28W/T5 L1256mm HF	456,26
7025338HF-F	VIVA Solo sym direct/indirect	IP20 2x28W/T5 L1256mm HFF	528,19
7025538	VIVA Solo sym direct/indirect	IP20 2x35W/T5 L1556mm HF	487,64
7025538HF-F	VIVA Solo sym direct/indirect	IP20 2x35W/T5 L1556mm HFF	558,26
7026338	Viva solo L1256 2x28 e d/i sym	single pull-switch	463,92
7026538	Viva solo L1556 2x35 e d/i sym	single pull-switch	495,67
7027338	Viva solo L1256 2x28 d d/i sym	double pull-switch	529,64
7027538	Viva solo L1556 2x35 d d/i sym	double pull-switch	561,12
7075338	VIVA Solo sym direct/indirect	IP20 2x28W/T5 L1256mm HF	443,51
7075338HF-F	VIVA Solo sym direct/indirect	IP20 2x28W/T5 L1256mm HFF	515,81
7075538	VIVA Solo sym direct/indirect	IP20 2x35W/T5 L1556mm HF	472,52
7075538HF-F	VIVA Solo sym direct/indirect	IP20 2x35W/T5 L1556mm HFF	543,71
7076338	Viva solo L1256 2x28 e d/i sym	Single pull-switch	451,18
7076538	Viva solo L1556 2x35 e d/i sym	Single pull-switch	482,17
7077338	VIVA solo L1256 2x28 d d/i sym	Double pull-switch	538,97
7077538	Viva solo L1556 2x35 d d/i sym	Double pull-switch	546,00

HFF = Dimmable with SwitchDIM, DSI or DALI. 1-10V on request.



CAP

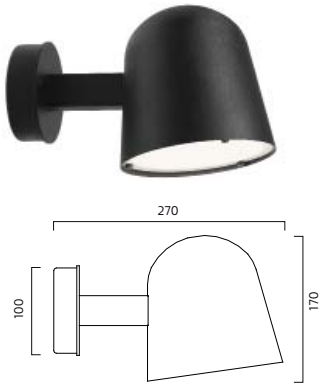

Finish: Painted steel. or galvanized steel. Matt tempered glass.

Installation: On wall.

Connection: Terminal block 3x4mm². When HFF 5x4mm².

Design: Jens Fager 2014.

ART	DESCRIPTION		PRICE/EUR
8290101	CONVEX wall/outdoor white	IP44 LED	482,04
8290101HF-F	CONVEX Wall white	IP20 LED Dim	516,42
8290106	CONVEX wall/outdoor black	IP44 LED	482,04
8290106HF-F	CONVEX wall black	IP20 LED Dim	516,42
8290183	CONVEX wall/outdoor galv	IP44 LED	523,24
8290183HF-F	CONVEX wall galv	IP20 LED Dim	556,97

HFF = Dimmbar via SwitchDIM, DSI alt. DALI.



CAP

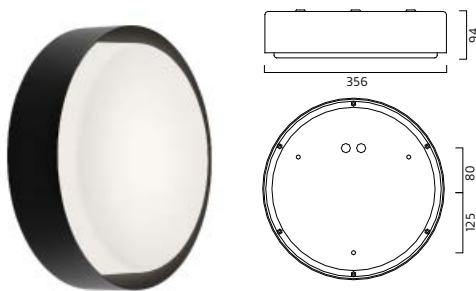

Finish: Shade in opal PMMA. Base in black painted aluminium. Other colours on request.

Installation: In ceiling or on wall.

Connection: Terminal block 5*4mm².

Design: Joel Karlsson, Krook & Tjäder Design 2013

ART	DESCRIPTION		PRICE/EUR
3305106	CAP wall opal/black	IP54 26-42W/Gx24q HF D350 mm	359,60
3305106HF-F	CAP wall black/opal D350 mm	IP54 26-42W/Gx24q Dim	425,49
3306106	CAP ceiling-wall black D350 mm	IP54 LED 15,3W/1800 lm	457,84
3306106HF-F	CAP ceiling wall black D350 mm	IP54 LED 15,3W/1800 lm Dim	540,75

HFF = Dimmable with SwitchDIM, DSI or DALI. 1-10V on request.



CLARK

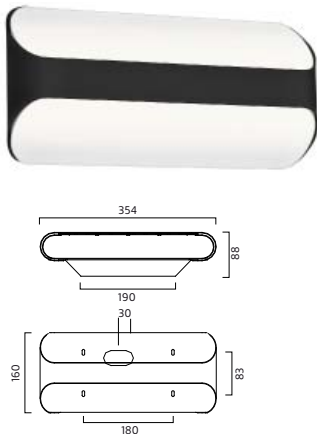

Finish: Painted metal, white, black or yellow as standard. The reflector is always white. Other colours on request.

Installation: On wall.

Connection: Terminal block 5*4mm².

Design: Böttcher + Henssler 2013

ART	DESCRIPTION		PRICE/EUR
8225101	CLARK wall white/white	IP20 LED HF B350 mm	274,33
8225101HF-F	CLARK wall white/white	IP20 LED HFF B350 mm	344,67
8225106	CLARK wall white/black	IP20 LED HF B350 mm	287,52
8225106HF-F	CLARK wall white/black	IP20 LED HFF B350 mm	357,86
8225114	CLARK wall white/yellow	IP20 LED HF B350 mm	287,52
8225114HF-F	CLARK wall white/yellow	IP20 LED HFF B350 mm	357,86

HFF = Dimmable with SwitchDIM, DSI or DALI. 1-10V on request.



THIRTY

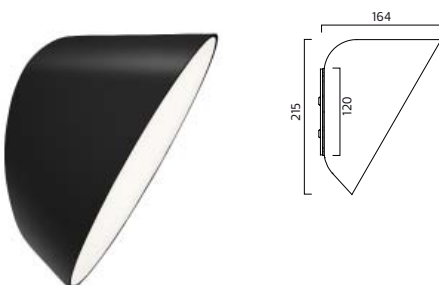

Finish: Turnable wall- ceiling fixture in painted ABS. Diffuser in microprisma. Other colours on request.

Installation: In ceiling or on wall.

Connection: Terminal block 5x4mm².

Design: Samuel Wilkinson 2013

ART	DESCRIPTION		PRICE/EUR
8245101	THIRTY wall/ceiling white	IP20 LED HF D245 mm	502,00
8245101HF-F	THIRTY wall/ceiling white	IP20 LED HFF D245 mm	544,36
8245106	THIRTY wall/ceiling black	IP20 LED HF D245 mm	502,00
8245106HF-F	THIRTY wall/ceiling black	IP20 LED HFF D245 mm	544,36

HFF = Dimmable with SwitchDIM, DSI or DALI. 1-10V on request.



PISTILL

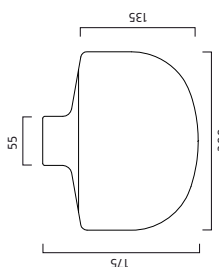

Finish: Base in painted aluminium. Matt opal UV-stable polyethene. Incl. lightsource

Installation: Ceiling or wall.

Connection: Terminal block 3x4mm².

Design: Jens Fager 2012.

ART	DESCRIPTION		PRICE/EUR
8090101	PISTILL wall/ceiling white	IP55 10-13W/Gx24q HF D200 mm	330,22
8090141	PISTILL wall/ceiling orange	IP55 10-13W/Gx24q HF D200 mm	330,22
8090195	PISTILL wall/ceiling grey	IP55 10-13W/Gx24q HF D200 mm	330,22
8091101	PISTILL wall/ceiling white	IP55 7W/E27/Mini Twist D200 mm	301,07
8091141	PISTILL wall/ceiling orange	IP55 7W/E27/Mini Twist D200 mm	301,07
8091195	PISTILL wall/ceiling grey	IP55 7W/E27/Mini Twist D200 mm	301,07
8092101	PISTILL wall/ceiling white	IP55 LED/4 W D200 mm	314,15
8092141	PISTILL wall/ceiling orange	IP55 LED/4 W D200 mm	314,15
8092195	PISTILL wall/ceiling grey	IP55 LED/4 W D200 mm	314,15

GRID

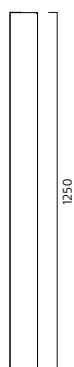
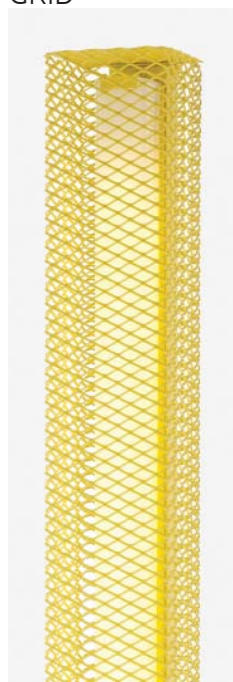

Finish: Perforated metal with square holes or expanded metal. Yellow, orange, clear painted metal or transparent gold varnish. Grid has a raw finish and one can see weldings through the transparent varnish. Diffuser in opal acrylic. T5 Eco

Installation: On wall.

Connection: Terminal block 3x4mm².

Design: Front 2012.

ART	DESCRIPTION		PRICE/EUR
T5 Light Tube			
81341XX	GRID wall square holes yellow	IP20 25/28/50/54W T5 HF L1250	638,96
81341XXHF-F	GRID wall square holes yellow	IP20 25/28/50/54 T5 HFF L1250	695,40
81351XX	GRID wall expanded metal yellow	IP20 25/28/50/54W T5 HF L1250	638,96
81351XXHF-F	GRID wall expanded metal yellow	IP20 25/28/50/54 T5 HFF L1250	695,40
LED 2600 Lumen			
81361XX	GRID ceiling squarehole yellow	IP20 LED 2600LM/22W L1250	844,12
81361XXHF-F	GRID ceiling squarehole yellow	IP20 LED 2600LM/22W L1250	956,59
81371XX	GRID ceiling expanded yellow	IP20 LED 2600LM/22W L1250	844,12
81371XXHF-F	GRID ceiling expanded yellow	IP20 LED 2600LM/22W L1250	956,59

HFF = Dimmable with SwitchDIM, DSI or DALI. 1-10V on request.
 XX = -14 Yellow, -41 Orange, -76 Metal, -77 Gold



WOOD

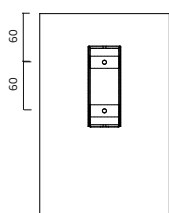
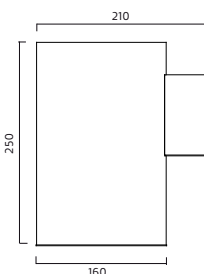

Finish: Oiled oak veneer natural or black stained. Matt acrylic diffuser. When metal halide clear glass. Available in other wood finishes and stains on request.

Installation: On wall, can be installed in different directions.

Connection: Terminal block 5x4mm².

Design: Fredrik Mattson 2010.

ART	DESCRIPTION		PRICE/EUR
8030132	WOOD wall fixture oiled oak	IP20 26-32W/Gx24q HF D160 mm	521,75
8030132HF-F	WOOD wall fixture oiled oak	IP20 32W/Gx24q HFF D160 mm	574,74
8030136	WOOD wall fixture black oak	IP20 26-32W/Gx24q HF D160 mm	521,75
8030136HF-F	WOOD wall fixture black oak	IP20 32W/Gx24q HFF D160 mm	574,74
8031132	WOOD wall fixture oiled oak	IP20 35W/G12 D160 mm	636,37
8031136	WOOD wall fixture black oak	IP20 35W/G12 D160 mm	636,37
8032132	WOOD wall fixture oiled oak	LED/2000Lm/830 D160 mm	1 389,62
8032136	WOOD wall fixture black oak	LED/2000Lm/830 D160 mm	1 389,62

HFF = Dimmable with SwitchDIM, DSI or DALI. 1-10V on request.



XM

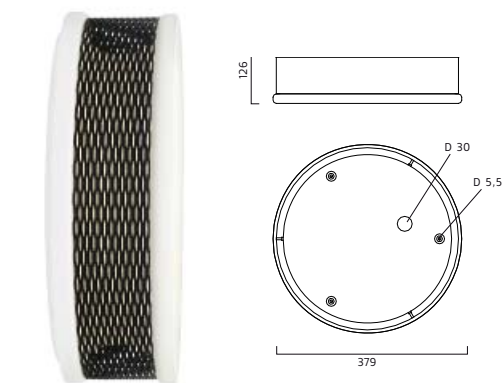

Finish: Base in white painted aluminium. Matt opal glass and shade in expanded metal, white, black or copper.

Installation: Ceiling or wall.

Connection: Terminal block 5x4mm².

Design: Joel Karlsson, Krook & Tjäder Design 2011.

ART	DESCRIPTION		PRICE/EUR
8080101	XM wall-ceiling lamp white	IP20 26-42W/Gx24q HF D400 mm	591,06
8080101HF-F	XM wall-ceiling lamp white	IP20 42W/Gx24q HFF D400 mm	642,52
8080106	XM wall-ceiling lamp black	IP20 26-42W/Gx24q HF D400 mm	591,06
8080106HF-F	XM wall-ceiling lamp black	IP20 42W/Gx24q HFF D400 mm	642,52
8081101	XM Ceiling-wall HF white/white	IP20 LED/1800LM/15,3W/3000K	680,29
8081101HF-F	XM Ceiling-wall HFF white/whit	IP20 LED/1800LM/15,3W/3000K	798,01
8081106HF-F	XM Ceiling-wall HFF white/blac	IP20 LED/1800LM/15,3W/3000K	798,01

With motion detector

8081101S	XM Ceiling-wall HF white/white	IP20 LED/1800LM/15,3W/3000K	749,25
8081101HFFS	XM Ceiling-wall HFF white/whit	IP20 LED/1800LM/15,3W/3000K	838,33
8081106	XM Ceiling-wall HF white/blac	IP20 LED/1800LM/15,3W/3000K	749,25
8081106HFFS	XM Ceiling-wall HFF white/blac XM shade in copper	IP20 LED/1800LM/15,3W/3000K	838,33 on request

HFF = Dimmable with SwitchDIM, DSI or DALI. 1-10V on request.

STITCH

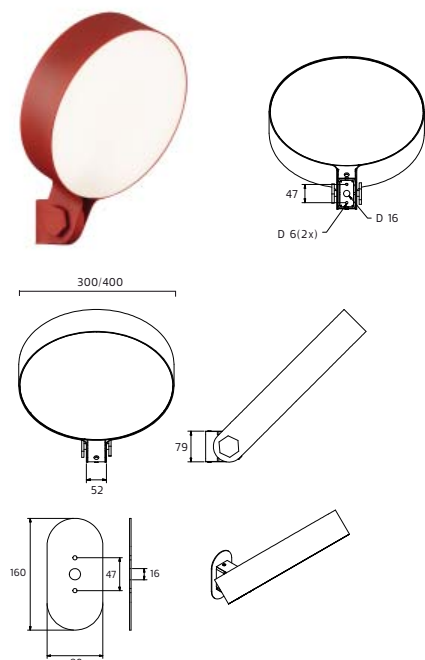

Finish: Painted metal and matt opal acrylic. For T5 circular tube. Tools are required to adjust the angle. State requested angle when ordering. Available in angle 0°, 30°, 60° och 90°.

Installation: Ceiling or wall. Wall/ceiling washer for installation on porous material available as assery.

Connection: Terminal block 5x4mm²

Design: Mattias Ståhlbom 2010.

ART	DESCRIPTION		PRICE/EUR
8070101	STITCH wall-ceiling lamp white	IP20 22W/2Gx13 HF D300 mm	436,23
8070101HF-F	STITCH wall-ceiling lamp white	IP20 22W/2Gx13 HFF D300 mm	495,19
8070106	STITCH wall-ceiling lamp black	IP20 22W/2Gx13 HF D300 mm	436,23
8070106HF-F	STITCH wall-ceiling lamp black	IP20 22W/2Gx13 HFF D300 mm	495,19
8070107	STITCH wall-ceiling lamp red	IP20 22W/2Gx13 HF D300 mm	436,23
8070107HF-F	STITCH wall-ceiling lamp red	IP20 22W/2Gx13 HFF D300 mm	495,19
8070301	STITCH wall-ceiling lamp white	IP20 40W/2Gx13 HF D400 mm	513,71
8070301HF-F	STITCH wall-ceiling lamp white	IP20 40W/2Gx13 HFF D400 mm	572,65
8070306	STITCH wall-ceiling lamp black	IP20 40W/2Gx13 HF D400 mm	513,71
8070306HF-F	STITCH wall-ceiling lamp black	IP20 40W/2Gx13 HFF D400 mm	572,65
8070307	STITCH wall-ceiling lamp red	IP20 40W/2Gx13 HF D400 mm	513,71
8070307HF-F	STITCH wall-ceiling lamp red	IP20 40W/2Gx13 HFF D400 mm	572,65

HFF = Dimmable with SwitchDIM, DSI or DALI. 1-10V on request.

ACCESSORIES

98070101	STITCH wall washer white	160x80	10,45
98070106	STITCH wall washer black	160x80	10,45
98070107	STITCH wall washer red	160x80	10,45

RUBBER

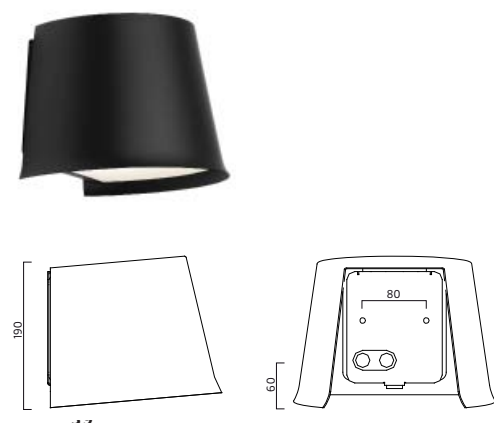

Finish: Painted aluminium. Diffuser in Microprisma..

Installation: On wall.

Connection: Terminal block 5x4mm². Knock-out for external mains.

Design: TAF - Mattias Ståhlbom & Gabriella Gustafsson 2011.

ART	DESCRIPTION		PRICE/EUR
8172301	RUBBER wall fixtures white	IP44 26-32W/Gx24q HF B255 mm	387,55
8172301HF-F	RUBBER wall fixtures white	IP44 32W/Gx24q-3 HFF B255 mm	468,25
8172306	RUBBER wall fixtures black	IP44 26-32W/Gx24q HF B255 mm	387,55
8172306HF-F	RUBBER wall fixtures black	IP44 32W/Gx24q-3 HFF B255 mm	468,25
8172349	RUBBER wall fixtures beige	IP44 26-32W/Gx24q HF B255 mm	387,55
8172349HF-F	RUBBER wall fixtures beige	IP44 32W/Gx24q-3 HFF B255 mm	468,25
8173301	RUBBER wall fixtures white	IP44 13W/1279LM/3000K	556,55
8173306	RUBBER wall fixtures black	IP44 13W/1279LM/3000K	556,55
8173349	RUBBER wall fixtures beige	IP44 13W/1279LM/3000K	556,55

HFF = Dimmable with SwitchDIM, DSI or DALI. 1-10V on request.

PXL



Finish: White painted metal or galvanized metal.

Installation: On Wall.

Connection: Snap-in terminal block 3x4mm². Knockout for external mains cable from above.

Design: Fredrik Mattson 2008.

ART	DESCRIPTION		PRICE/EUR
7772101	PXL wall lamp white	IP20 18W/Gx24q-2 B320 mm	443,53
7772183	PXL wall lamp galv	IP20 18W/Gx24q-2 B320 mm	443,53
7773101	PXL wall lamp white	IP20 60W/E27 B320 mm	411,71
7773183	PXL wall lamp galv	IP20 60W/E27 B320 mm	411,71

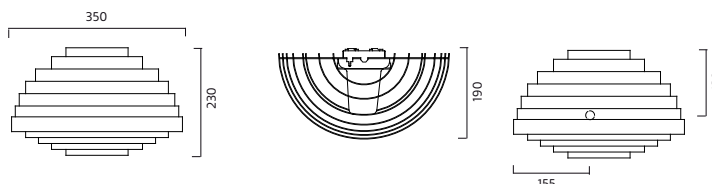

SPJUTET

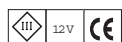
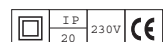
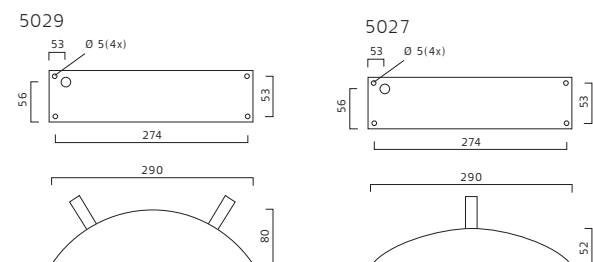
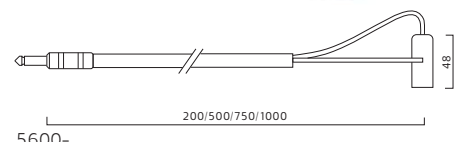

Finish: White and chromed steel.

Installation: Ceiling, on 3-phase track or on wall.

Connection: Fixture incl. el-transformer. Terminal block 2x2,5mm².

Design: Stig Ahlström, Claes Koch.

ART	DESCRIPTION		PRICE/EUR
5020101	SPJUTET ceiling-/wallfitting	IP20 50W L145 incl transformer	145,04
5020301	SPJUTET ceiling-/wallfitting	IP20 50W L145 incl transformer	181,30
5027101	SPJUTET wallhold white	IP20 1x20-50W incl transform	174,08
5029101	SPJUTET wallhold white	IP20 2x20-50W incl transform	313,34
5600182	SPJUTET L200 mm chrome	IP20 20-50W/Gu5,3	93,64
5600382	SPJUTET L500 mm chrome	IP20 20-50W/Gu5,3	100,33
5600582	SPJUTET L750 mm chrome	IP20 20-50W/Gu5,3	103,36
5600782	SPJUTET L1000 mm chrome	IP20 20-50W/Gu5,3	114,61

ALLRIGHT

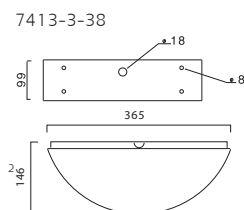
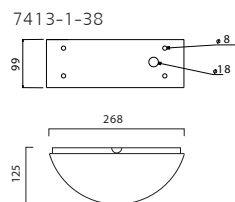

Finish: Anodized aluminium, natural, bronze or dark grey painted and white painted steel.

Diffuser: in prismatic acrylic.

Installation: Wall installation.

Connection: Terminal block 3x4mm².

Design: Per Sundstedt.

ART	DESCRIPTION		PRICE/EUR
7413138	ALLRIGHT wallamp aluminium	IP20 18W/Gx24q-2 HF B260 mm	267,72
7413197	ALLRIGHT wall fixtures bronze	IP20 18W/Gx24q-2 HF B268 mm	283,63
7413198	ALLRIGHT wall fixtures grey	IP20 18W/Gx24q-2 HF B268 mm	283,63
7413338	ALLRIGHT wall fixture aluminium	IP20 2x18W/Gx24q-2 HF B350 mm	342,44
7413338HF-F	ALLRIGHT wall lamp aluminium	IP20 32W/Gx24q-2 HFF B350 mm	353,70
7413397	ALLRIGHT wall fixtures bronze	IP20 2x18W/Gx24q-2 HF B365 mm	358,35
7413397HF-F	ALLRIGHT wall fixtures bronze	IP20 32W/Gx24q-2 HFF B365 mm	369,62
7413398	ALLRIGHT wall fixtures grey	IP20 2x18W/Gx24q-2 HF B365 mm	358,35
7413398HF-F	ALLRIGHT wall fixtures grey	IP20 32W/Gx24q-2 HFF B365 mm	369,62
7426338	ALLRIGHT wall fixture alum	IP23 LED/1279LM/3000K B365 mm	447,17
7426397	ALLRIGHT wall fixtures bronze	IP23 LED/13W/1279LM/3000K B365	463,08
7426398	ALLRIGHT wall fixtures grey	IP23 LED/13W/1279LM/3000K B365	463,08

HFF = Dimmable with SwitchDIM, DSI or DALI. 1-10V on request.



FOTO

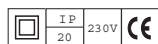
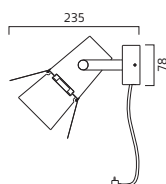
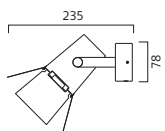

Finish: Wall fixture with adjustable spotlight. Painted steel and die-casted aluminium.

Installation: Fixed installation, terminal block 2x2,5mm² or 2,5 m cable and plug. Dimmer available as accessory. Black finish has black cable, other finishes have white cable.

Design: Thomas Bernstrand, Mattias Ståhlbom.

ART	DESCRIPTION		PRICE/EUR
77655101	FOTO spot wall/ceiling white	35W/GU10 fixed installation	325,32
7655106	FOTO spot wall/ceiling black	35W/GU10 fixed installation	325,32
7655107	FOTO spot wall/ceiling red	35W/GU10 fixed installation	325,32
7655108	FOTO spot wall/ceiling blue	35W/GU10 fixed installation	325,32
7655114	FOTO spot wall/ceiling yellow	35W/GU10 fixed installation	325,32
7655141	FOTO spot wall/ceiling orange	35W/GU10 fixed installation	325,32
7656101	FOTO spot wall white	35W/GU10 with 2,5 m flex	345,87
7656106	FOTO spot wall black	35W/GU10 with 2,5 m flex	345,87
7656108	FOTO spot wall blue	35W/GU10 with 2,5 m flex	345,87
7656114	FOTO spot wall yellow	35W/GU10 with 2,5 m flex	345,87
7656141	FOTO spot wall orange	35W/GU10 with 2,5 m flex	345,87
7755101	FOTO spot wall/ceiling white	20W/GU5,3 12V fix installation	388,73
7755106	FOTO spot wall/ceiling black	20W/GU5,3 12V fix installation	388,73
7755107	FOTO spot wall/ceiling red	20W/GU5,3 12V fix installation	388,73
7755108	FOTO spot wall/ceiling blue	20W/GU5,3 12V fix installation	388,73
7755114	FOTO spot wall/ceiling yellow	20W/GU5,3 12V fix installation	388,73
7755141	FOTO spot wall/ceiling orange	20W/GU5,3 12V fix installation	388,73
7756101	FOTO spot wall white	20W/GU5,3 12V with 2,5 m flex	409,70
7756106	FOTO spot wall black	20W/GU5,3 12V with 2,5 m flex	409,70
7756107	FOTO spot wall red	20W/GU5,3 12V with 2,5 m flex	409,70
7756108	FOTO spot wall blue	20W/GU5,3 12V with 2,5 m flex	409,70
7756114	FOTO spot wall yellow	20W/GU5,3 12V with 2,5 m flex	409,70
7756141	FOTO spot wall orange	20W/GU5,3 12V with 2,5 m flex	409,70

595

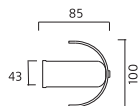

Finish: Zincgrey painted steel. Shade in matt opal glass or matt opal acrylic.

Installation: Wall or ceiling installation. Spacer for surface-run mains available as accessory.

Connection: Snap-in terminal block 3x4mm². Two entry holes.

Design: Inger Thede.

ART	DESCRIPTION		PRICE/EUR
7630121	595 Ceil/wall fixture glassl	IP20 14W/T5 HF L600 mm	222,63
7630121HF-F	595 Ceil/wall fixture glass	IP20 14W/T5 HFF L600 mm	298,33
7630127	595 Ceil/wall fixture acrylic	IP20 14W/T5 HF L600 mm	181,18
7630127HF-F	595 Ceil/wall fixture acrylic	IP20 14W/T5 HFF L600 mm	274,04

ACCESSORIES

97630121	595 Spacer f. surface-run main		35,44
----------	--------------------------------	--	-------

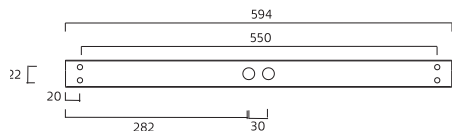
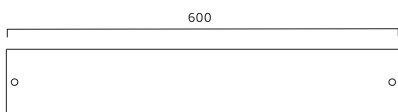

BOX ONE

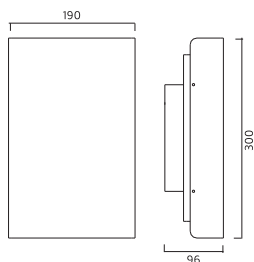

Finish: Shade in matt opal glass, striped matt glass or matt opal acrylic.

Installation: On wall.

Connection: Snap in terminal block 5x4mm².

Design: Olle Anderson.

ART	DESCRIPTION		PRICE/EUR
4180121	BOX ONE wall fixture glass	IP20 18W/2G11 HF H300 mm	265,78
4180121HF-F	BOX ONE wall fixture opalshade	IP20 18W/2G11 HFF H300 mm	319,26
4180123	BOX ONE wall fixture striped	IP20 18W/2G11 HFF H300 mm	250,15
4180123HF-F	BOX ONE wall fixture striped	IP20 18W/2G11 HF-F H300 mm	304,37
4180127	BOX ONE wall fixture acrylic	IP20 18W/2G11 HF H300 mm	235,77



HFF = Dimmable with SwitchDIM, DSI or DALI. 1-10V on request.

595



Finish: Zincgrey painted steel. Shade in matt opal acrylic.

Installation: Wall or ceiling installation. Spacer for surface-run mains available as accessory.

Connection: Snap-in terminal block 3x4mm². Two entry holes.

Design: Inger Thede.

ART	DESCRIPTION		PRICE/EUR
7637127	595 Ceiling/wall acrylic	IP44 14W/T5 HF L600 mm	199,93
7639127	595 Ceiling/wall acrylic	IP44 LED L600 mm	351,49
7639127HFF	595 Ceiling/wall acrylic	IP44 LED L600 mm	400,70
ACCESSORIES			
97630121	595 Spacer f. surface-run main		35,44

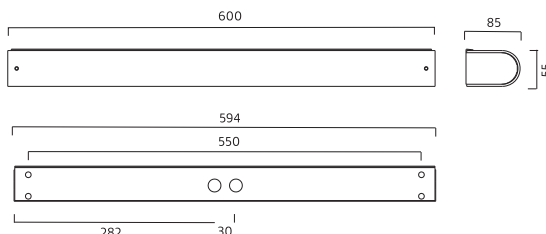

UPPSALA

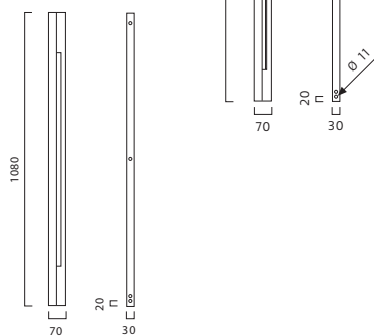

Finish: Zink-grey painted steel. Two versions available - light on one side and light on both sides.

Installation: Wall installation.

Connection: Terminal block 3x4mm².

Design: Björn Tegnell, Stefan Ståhlgren, White Design.

ART	DESCRIPTION	PRICE/EUR
7597187	UPPSALA fixture L1080 mm grey IP20 1x21W/T5 HF one side	408,98
7597187HF-F	UPPSALA fixture L1080 mm grey 21W/T5 HFF light one side	484,77
7597787	UPPSALA fixture L2000 zinc IP20 2x21W/T5 HF one side	533,55
7597787HF-F	UPPSALA fixture L2000 mm grey 2x21W/T5 HFF light one side	605,81
7598187	UPPSALA fixture L1080 mm grey IP20 1x21W/T5 HF both sides	408,98
7598187HF-F	UPPSALA fixture L1080 mm grey 1x21W/T5 HFF light both sides	484,77
7598787	UPPSALA fixture L2000 grey IP20 2x21W/T5 HF both sides	533,55
7598787HF-F	UPPSALA fixture L2000 mm grey 2x21W/T5 HFF light both sides	605,81

HFF = Dimmable with SwitchDIM, DSI or DALI. 1-10V on request.



MIMMI



Finish: Grey-painted steel. White pleated shade.

Installation: Wall installation.

Connection: Snap-in terminal block 5x4mm². Two cable entries. Knockout for external mains cable.

ART	DESCRIPTION	PRICE/EUR	
4414135	Mimmi wall fixture white	IP20 40W/E14 H270mm	227,29
4415135HF	Mimmi wall fixture white	IP20 PL18w/2g11 HF H270mm	346,89
4415135HF-F	MIMMI wall fixture white	IP20 18W/2G11 HFF H270 mm	420,90

HFF = Dimmable with SwitchDIM, DSI or DALI. 1-10V on request.

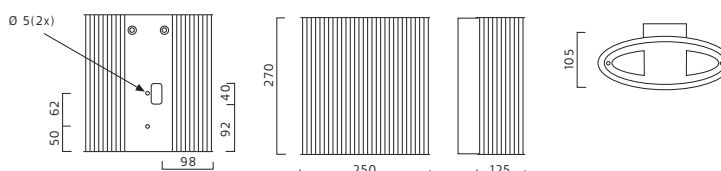

ARCAD



4038

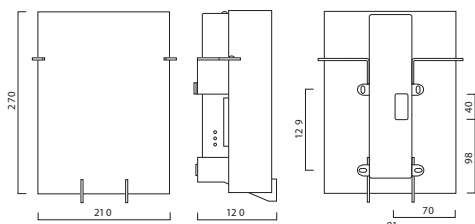

4039/4041

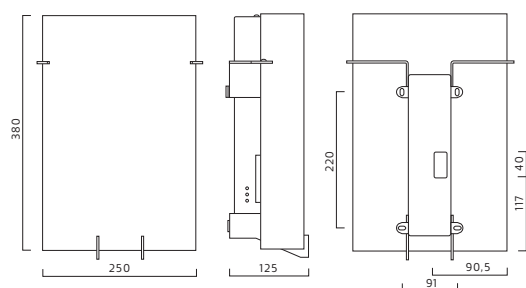

Finish: Dark-grey painted steel. Shade in matt opal glass.
Installation: Wall installation.
Connection: Snap-in terminal block 5x4mm². Two cable entries.
Design: Per Sundstedt.

ART	DESCRIPTION		PRICE/EUR
4038101HF	ARCAD wall fixture glass	IP20 11W/2G7 H270 mm	293,74
4038131HF	ARCAD wall fixture glass/stripe	IP20 11W/2G7 H270 mm	341,90
4039101	ARCAD wall fixture glass	IP20 2x40W/E14 H380mm	280,69
4039127	ARCAD wall fixture acrylic	IP20 2x40W/E27 H380mm	209,14
4039131	ARCAD wall fixture stripe	IP20 2x40W/E14 H380 mm	336,28
4040101HF	ARCAD wall fixture glass	IP20 18W/2G11 HF H290 mm	304,36
4040101HF-F	ARCAD wall fixture glass	IP20 18W/2G11 HFF H290mm	368,64
4040131HF	ARCAD wall fixture glass/stripe	IP20 18W/2G11 H290mm	352,52
4040131HF-F	ARCAD wall fixture glass/stripe	IP20 18W/2G11 HFF H290mm	415,01
4041101HF	ARCAD wall fixture glass	IP20 24W/2G11 HF H380 mm	336,90
4041101HF-F	ARCAD wall fixture glass	IP20 24W/2G11 HFF H380mm	399,87
4041131HF	ARCAD wall fixture shade glass	IP20 24W/2G11 HF H380 mm	395,67
4041131HF-F	ARCAD wall fixture glass/stripe	IP20 24W/2G11 HFF H380mm	456,46

HF = Dimmable with SwitchDIM, DSI or DALI. 1-10V on request.

ARCAD

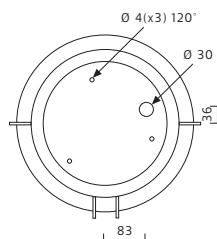
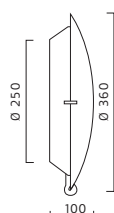

Finish: Dark-grey painted steel. Shade in matt opal glass.
Installation: Wall installation.
Connection: Snap-in terminal block 5x4mm². Two cable entries.
 Distance-piece for external mains cable available as accessory.
Design: Per Sundstedt.

ART	DESCRIPTION		PRICE/EUR
4063121HF	ARCAD wall fixture glass	IP20 22W/T5 HF D360mm	363,98
4063121HF-F	ARCAD wall fixture glass	IP20 22W/T5 HFF D360mm	455,88

HF = Dimmable with SwitchDIM, DSI or DALI. 1-10V on request.



PISTILL

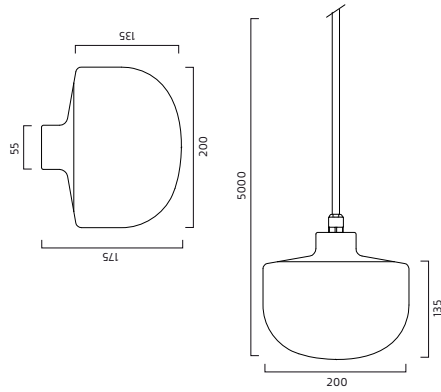

Finish: Base in painted aluminium. Matt opal acrylic. Incl. lightsource.
Installation: Ceiling or wall. Or as pendant with 5 m black rubber cable.
Connection: Terminal block 3x4mm².
Design: Jens Fager 2012.

ART	DESCRIPTION		PRICE/EUR
8090101	PISTILL wall/ceiling white	IP55 10-13W/Gx24q HF D200 mm	340,12
8090141	PISTILL wall/ceiling orange	IP55 10-13W/Gx24q HF D200 mm	340,12
8090195	PISTILL wall/ceiling grey	IP55 10-13W/Gx24q HF D200 mm	340,12
8091101	PISTILL wall/ceiling white	IP55 7W/E27/Mini Twist D200 mm	310,10
8091141	PISTILL wall/ceiling orange	IP55 7W/E27/Mini Twist D200 mm	310,10
8091195	PISTILL wall/ceiling grey	IP55 7W/E27/Mini Twist D200 mm	310,10
8092101	PISTILL wall/ceiling white	IP55 LED/4 W D200 mm	323,57
8092141	PISTILL wall/ceiling orange	IP55 LED/4 W D200 mm	323,57
8092195	PISTILL wall/ceiling grey	IP55 LED/4 W D200 mm	323,57
8096101	PISTILL pendant opal/white	IP55 10-13W/Gx24q D200 mm	411,79
8096141	PISTILL pendant orange	IP55 10-13W/Gx24q D200 mm	411,79
8096195	PISTILL pendant opal/grey	IP55 10-13W/Gx24q D200 mm	411,79
8097101	PISTILL pendant opal/white	IP55 7W/E27/Mini Twist D200 mm	374,05
8097141	PISTILL pendant orange	IP55 7W/E27/Mini Twist D200 mm	374,05
8097195	PISTILL pendant opal/grey	IP55 7W/E27/Mini Twist D200 mm	374,05
8098101	PISTILL pendant opal/white	IP55 LED/4 W D200 mm	395,08
8098141	PISTILL pendant orange	IP55 LED/4 W D200 mm	395,08
8098195	PISTILL pendant opal/grey	IP55 LED/4 W D200 mm	395,08



595



Finish: Zincgrey painted steel. Shade in matt acrylic or matt opal glass.
Installation: On wall or ceiling horizontal or vertical installation. Spacer for surface-run mains available as accessory.
Connection: Snap-in terminal block 3x4mm². Two entry holes.

ART	DESCRIPTION		PRICE/EUR
7637127	595 Ceiling/wall acrylic	IP44 14W/T5 HF L600 mm	199,93
7639127	595 Ceiling/wall acrylic	IP44 LED L600 mm	351,49
7639127HFF	595 Ceiling/wall acrylic	IP44 LED L600 mm	400,70

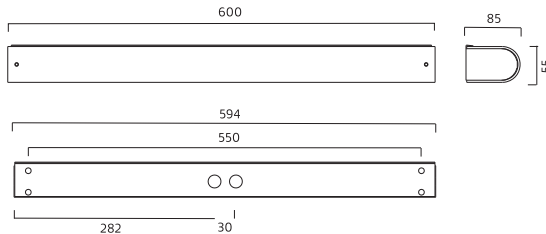

ALLRIGHT

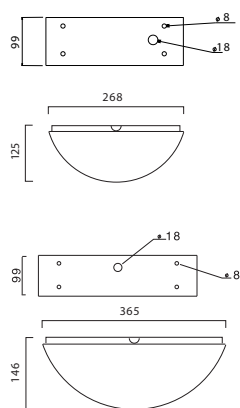

Finish: Anodized aluminium, natural, bronze or dark grey painted and white painted steel. Diffuser in prismatic acrylic.
Installation: On wall.
Connection: Snap-in terminal block 3x4mm². 7417-terminal block 5x4mm².
Design: Per Sundstedt.

ART	DESCRIPTION		PRICE/EUR
7416138	ALLRIGHT wall fixture aluminium	IP23 18W/Gx24q-2 HF B268 mm	310,94
7416197	ALLRIGHT wall fixtures bronze	IP23 18W/Gx24q-2 HF B268 mm	326,85
7416198	ALLRIGHT wall fixtures grey	IP23 18W/Gx24q-2 HF B268 mm	326,85
7416338	ALLRIGHT wall fixture alumini	IP23 2x18W/Gx24q-2 HF B365 mm	384,72
7416397	ALLRIGHT wall fixtures bronze	IP23 2x18W/Gx24q-2 HF B365 mm	400,64
7416398	ALLRIGHT wall fixtures grey	IP23 2x18W/Gx24q-2 HF B365 mm	400,64
7417338	ALLRIGHT wall fix. B365 alum	IP23 1x18W/Gx24q-2 HF w socket	391,05
7417397	ALLRIGHT wall fixtures bronze	IP23 18W/Gx24q-2 HF B365 mm	406,96
7417398	ALLRIGHT wall fixtures grey	IP23 18W/Gx24q-2 HF B365 mm	406,96
7426338	ALLRIGHT wall fixture alum	IP23 LED/1279LM/3000K B365 mm	447,17
7426397	ALLRIGHT wall fixtures bronze	IP23 LED/13W/1279LM/3000K B365	463,08
7426398	ALLRIGHT wall fixtures grey	IP23 LED/13W/1279LM/3000K B365	463,08
7427338	ALLRIGHT wall fixture alum	IP23 LED/1279LM/3000K B365 mm	510,29
7427397	ALLRIGHT wall fixtures bronze	IP23 LED/13W/1279LM/3000K B365	526,21
7427398	ALLRIGHT wall fixtures grey	IP23 LED/13W/1279LM/3000K B365	526,21

VIVA

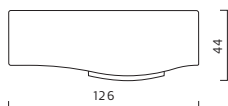

Viva should be used in the longest lengths practicable one.

Finish: Anodized aluminium with rigid louvre.

Installation: On top shelf.

Connection: 2 pcs snap-in terminal block 3x4mm². One in each end.

Design: Per Sundstedt.

ART	DESCRIPTION	PRICE/EUR
7105138	VIVA Combi L725 sym direct IP20 1x14W/T5 HF	300,67
7105138HF-F	Viva com 725 1x14 hff d sym	364,71
7105238	VIVA combi L900 1x21 w d sym	324,37
7105238HF-F	Viva combi L900 1x21 hff d sym	388,09
7105338	VIVA Combi L1250 sym direct	352,29
7105338HF-F	Viva combi 1250 1x28 hff d sym	415,01
7105438	VIVA combi L1450 2x14 w d sym	412,46
7105438HF-F	Viva combi 1450 2x14 hff d sym	486,14
7105538	VIVA Combi L1550 sym direkt IP20 1x35W/T5 HF	384,14
7105538HF-F	Viva combi 1550 1x35 hff d sym	445,65
7105638	VIVA Combi L1800 sym direct IP20 2x21W/T5 HF	464,44
7105638HF-F	Viva combi 1800 2x21 hff d sym	655,30
7105738	VIVA Combi L2450 sym direkt IP20 2x28W/T5 HF	545,93
7105738HF-F	Viva combi 2450 2x28 hff d sym	740,58
7105838	Viva combi L3050 2x35 w d sym IP20 2x35W/T5 L3050mm	603,97
7105838HF-F	VIVA Combi sym dir alum IP20 2x35W/T5 L3050 mm	796,39

HF = Dimmable with SwitchDIM, DSI or DALI. 1-10V on request.

ACCESSORIES

7304138	VIVA shelf bracke for topshef	29,22
7310138	VIVA straight connector	10,80
7317138	VIVA end panel right	5,83
7318138	VIVA end panel left	5,83

READY

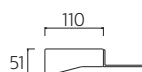

Finish: Grey painted steel. Available in other colours and lengths after request.

Installation: On top shelf or on top of sidepanel.

Connection: Start fixture includes end cap. Plus fixtures include quick-fix cable-connections.

Design: R. Aosta.

ART	DESCRIPTION	PRICE/EUR
7360286	READY shelf fixture L889 mm gr IP20 21W/T5 HF start/left	258,53
7360386	READY shelf fixture L900 mm gr IP20 21W/T5 HF start/left	258,53
7361286	READY shelf fixture L889 mm gr IP20 21W/T5 HF start/right	258,53
7361386	READY shelf fixture L900 mm gr IP20 21W/T5 HF start/right	258,53
7362286	READY shelf fixture L889 mm gr IP20 21W/T5 HF plus right	249,54
7362386	READY shelf fixture L900 mm gr IP20 21W/T5 HF plus right	249,54

ACCESSORIES

97360186	READY end cap left	11,27
97361186	READY end cap right	11,27
97362186	READY shelf fitting for installation on topshef	9,10
97363186h	READYshelf fitting sidepanel R	7,37
97363186v	READYshelf fitting sidepanel L	7,37
97363386	READY shelf fitting sidepanel double	8,41
97364186	READY T-connection white between two start fixtures	37,11
97365101	READY 4m cable and plug	31,19

LOOS

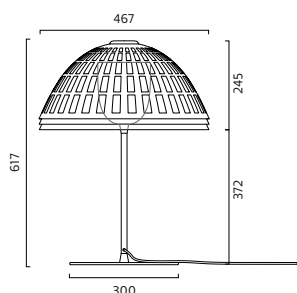

Finish: 2 or 3 shades in pressed felt. The light source is covered by an opal acrylic diffuser. The shades are turnable. Base in grey painted metal. Specify the shades from outside to inside.

Connection: 2,5 m transparent cable with switch and plug.

Design: Luca Nichetto 2013.

ART	DESCRIPTION		PRICE/EUR
8277296	LOOS table base for 2 shades	IP 20 E27/Max 42W	282,99
8277396	LOOS table base for 3 shades	IP 20 E27/Max 42W	282,99
SHADES			
8280101A	LOOS shade off white		207,29
8280111C	LOOS shade grey		207,29
8280114A	LOOS shade yellow/	Europost 62061	252,35
8280141B	LOOS shade orange/	Europost 63016	252,35
8280186B	LOOS shade antracite		207,29
8280195C	LOOS shade warm grey	Europost 61003	252,35

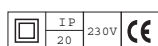

Mönster A/Pattern A

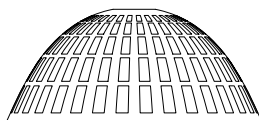

Mönster B/Pattern B

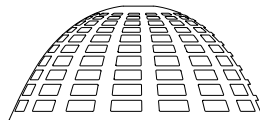

Mönster C/Pattern C

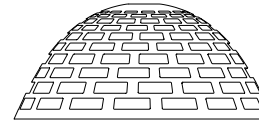

GLORIA

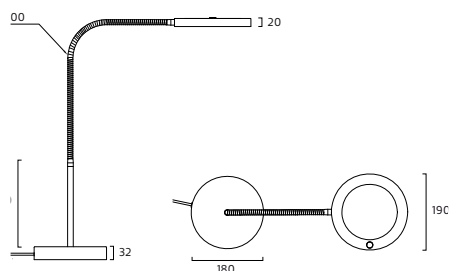

Finish: Painted aluminum. Diffuser in microprisma. White or black. Other colors on request.

Adjustable arm.

Installation: Table base or fixed through table top.

Connection: 2,5 m cable with plug.

Design: Fredrik Mattson 2012.

ART	DESCRIPTION		PRICE/EUR
8120101	GLORIA table lamps white	IP20 14,4W/LED	668,37
8120106	GLORIA table lamps black	IP20 14,4W/LED	668,37
8121101	GLORIA through table white	IP20 14,4W/LED	562,28
8121106	GLORIA through table black	IP20 14,4W/LED	562,28

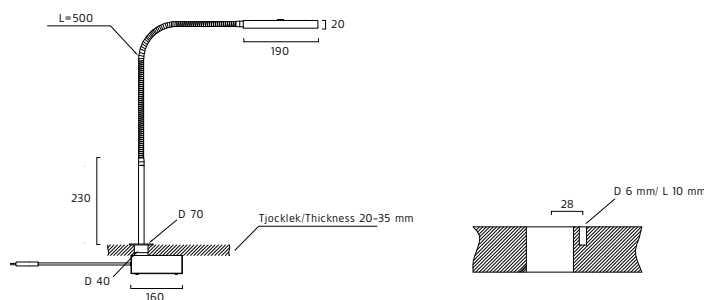

WOOD

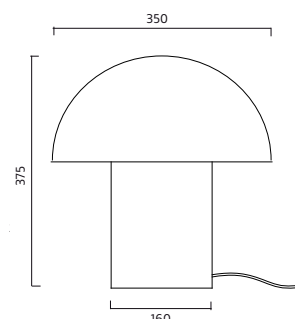

Finish: Oiled or stained oak veneer, painted aluminum or copper. Available in other wood finishes and stains on request.

Connection: 2,5 m cable and plug.

Design: Fredrik Mattson 2010.

ART	DESCRIPTION		PRICE/EUR
8035101	WOOD table lamp oak/white	IP20 60W/E27 H400 mm D350 mm	567,27
8035142	WOOD table lamp oak/pink	IP20 60W/E27 H400 mm D350 mm	567,27
8035143	WOOD table lamp oak/turquoise	IP20 60W/E27 H400 mm D350 mm	567,27
8036101	WOOD table lamp black/white	IP20 60W/E27 H400 mm D350 mm	567,27
8036142	WOOD table lamp black/pink	IP20 60W/E27 H400 mm D350 mm	567,27
8036143	WOOD table lamp black/turquoise	IP20 60W/E27 H400 mm D350 mm	567,27

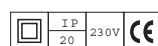

SHIBUYA

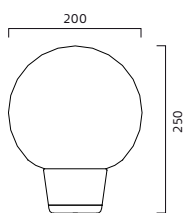

Finish: Painted aluminum and glass. Red RAL 0405070, grey RAL 0005000. Other colors on request.

Connection: 2,5 m cable with switch and plug.

Design: Thomas Bernstrand 2014.

ART	DESCRIPTION		PRICE/EUR
FIXTURE - TABLE BASE			
8222101	SHIBUYA table base white	IP20 Max 28W/E27	206,21
8222107	SHIBUYA table base red	IP20 Max 28W/E27	211,36
8222195	SHIBUYA table base grey	IP20 Max 28W/E27	211,36
SHADES			
8224107	SHIBUYA glass shade red	D200 mm	122,36
8224111	SHIBUYA glass shade grey	D200 mm	122,36
8224116	SHIBUYA glass shade cognac	D200 mm	122,36

RGB

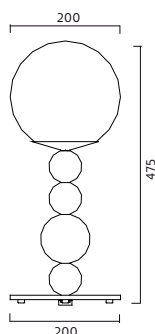

Finish: Glossy painted wooden balls. One ball with gold leaf. Shade in opal glass. Table base in glossy painted metal.

Connection: 2,5 m cable with switch and plug.

Design: Fredrik Mattson 2008.

ART	DESCRIPTION		PRICE/EUR
7776390	RGB table lamp	IP20 60W/E27 H475 mm	848,38

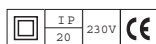

BOTTLE

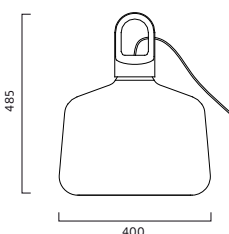

Finish: Cast aluminium and matt opal UV-stable polythene.

Connection: 2,5 m cable with switch and plug.

Design: Mattias Ståhlbom 2009.

ART	DESCRIPTION		PRICE/EUR
7731101	BOTTLE table/floor lamp white	IP20 18W/Gx24q-2 HF H485 D400	486,57
7731114	BOTTLE table/floor lamp yellow	IP20 18W/Gx24q-2 HF H485 D400	486,57
7731185	BOTTLE table/floor lamp alum	IP20 18W/Gx24q-2 HF H485 D400	486,57
7733101	BOTTLE table/floor lamp white	IP20 60W/E27 H485 D400	442,13
7733114	BOTTLE table/floor lamp yellow	IP20 60W/E27 H485 D400	442,13
7733185	BOTTLE table/floor alum	IP20 60W/E27 H485 D400	442,13

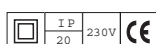

CAN

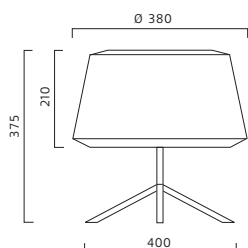

Finish: White or black painted aluminium with yellow coloured inside.

Connection: 2,5 m cable with switch and plug.

Design: Mattias Ståhlbom.

ART	DESCRIPTION		PRICE/EUR
7514101	CAN table fixture D380 whitely	IP20 75W/E27	487,60
7514106	CAN table fixture D380 blackly	IP20 75W/E27	487,60

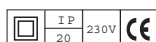

PXL

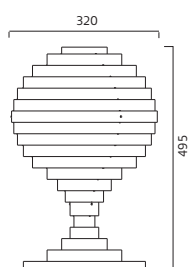

Finish: Aluminium and steel, multicolour.

Connection: 2,5 m cable, switch and plug.

Design: Fredrik Mattson, 2007.

ART	DESCRIPTION		PRICE/EUR
7771190	PXL table fixture multi	IP20 E27/60W D320 mm	991,72

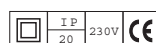

FOTO

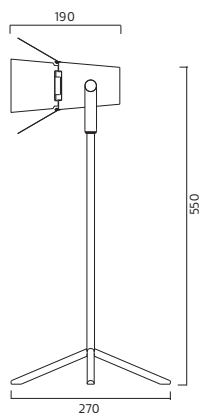

Finish: Table lamp with adjustable spotlight. Painted steel and die-casted aluminium.

Connection: 2,5 m cable, switch and plug. Black finish has black cable, other finishes have white cable. Dimmer available as accessory.

Design: Thomas Bernstrand, Mattias Ståhlbom.

ART	DESCRIPTION		PRICE/EUR
7652101	FOTO table fixture white	IP20 35W/GU10 H550 mm	449,67
7652106	FOTO table fixture black	IP20 35W/GU10 H550 mm	449,67
7652107	FOTO table fixture red	IP20 35W/GU10 H550 mm	449,67
7652108	FOTO table fixture blue	IP20 35W/GU10 H550 mm	449,67
7652114	FOTO table fixture yellow	IP20 35W/GU10 H550 mm	449,67
7652141	FOTO table fixture orange	IP20 35W/GU10 H550 mm	449,67
7752101	FOTO table/place fixture white	20W/GU5,3 12V H550 mm	515,72
7752106	FOTO table/place fixture black	20W/GU5,3 12V H550 mm	515,72
7752107	FOTO table/place fixture red	20W/GU5,3 12V H550 mm	515,72
7752108	FOTO table/place fixture blue	20W/GU5,3 12V H550 mm	515,72
7752114	FOTO table/place fixture yellow	20W/GU5,3 12V H550 mm	515,72
7752141	FOTO table/place fixture orange	20W/GU5,3 12V H550 mm	515,72

ACCESSORIES

97652101	Dimmer for table fixture, whit	Relco artnr: 101B	34,39
97652106	Dimmer for table fixture, blac	Relco artnr: 101N	34,39

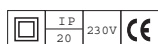

FLOOR FIXTURES

LOOS

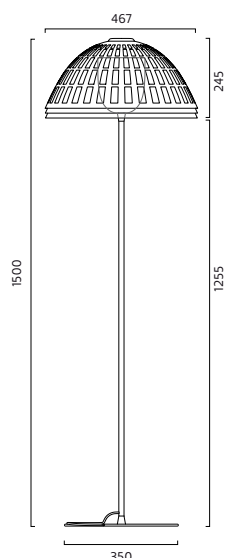

Finish: 2 or 3 shades in pressed felt. The light source is covered by an opal acrylic diffuser. The shades are turnable. Base in grey painted metal. Specify the shades from outside to inside.

Connection: 2,5 m transparent cable with switch and plug.

Design: Luca Nichetto 2013.

ART	DESCRIPTION		PRICE/EUR
8279296	LOOS floor base for 2 shades	IP20 E27/Max 42W	349,69
8279396	LOOS floor base for 3 shades	IP20 E27/Max 42W	349,69
SHADES			
8280101A	LOOS shade off white		207,29
8280111C	LOOS shade grey		207,29
8280114A	LOOS shade yellow/	Europost 62061	252,35
8280141B	LOOS shade orange/	Europost 63016	252,35
8280186B	LOOS shade antracite		207,29
8280195C	LOOS shade warm grey	Europost 61003	252,35

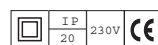

Mönster A/Pattern A



Mönster B/Pattern B

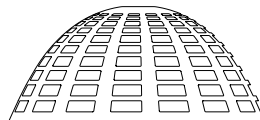

Mönster C/Pattern C

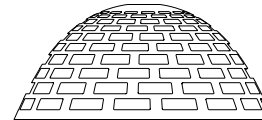

SILO

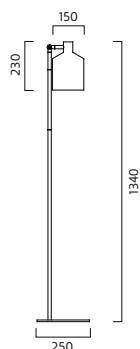

Finish: Painted aluminum and steel. Green RAL 6021, yellow RAL 1018.

Connection: 2,5 m cable and plug with switch on the cable.

Design: Note Design Studio 2014.

ART	DESCRIPTION		PRICE/EUR
8208101	SILO floor lamp white	IP20 E27 max 50W H1350 mm	417,15
8208106	SILO floor lamp black	IP20 E27 max 50W H1350 mm	417,15
8208112	SILO floor lamp green	IP20 E27 max 50W H1350 mm	453,20
8208114	SILO floor lamp yellow	IP20 E27 max 50W H1350 mm	453,20

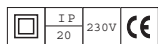

GLORIA

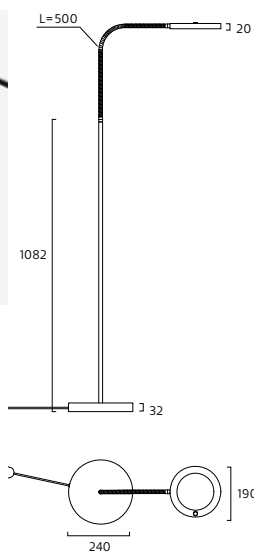

Finish: White or black painted aluminum. Diffuser in microprisma. White or black. Other colors on request. Adjustable arm.

Connection: 2,5 m cable with plug.

Design: Fredrik Mattson 2012.

ART	DESCRIPTION		PRICE/EUR
8125101	GLORIA floor lamps white	IP20 14,4W/LED	742,63
8125106	GLORIA floor lamps black	IP20 14,4W/LED	742,63



LIGHT HOUSE



Finish: White painted metal. Diffuser in matt akrylic.
Connection: 2,5 m white cable with switch and plug.
Design: Thomas Sandell 2009.

ART	DESCRIPTION		PRICE/EUR
7791101	LIGHT HOUSE floor lamp white	IP20 18W/Gx24q-2 H600 B400	548,56
7792101	LIGHT HOUSE floor lamp white	IP20 75W/E27 H600 B400/300	483,06

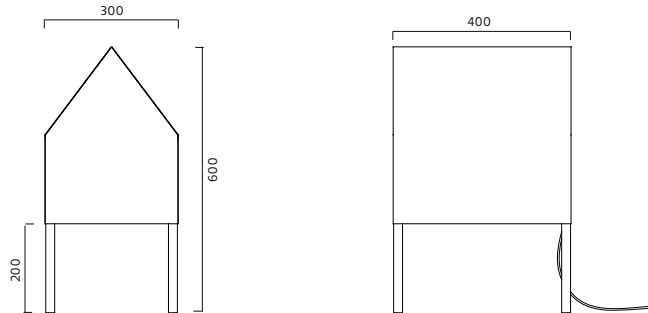
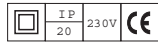

BOTTLE

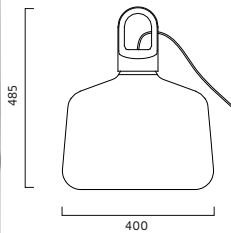

Finish: Cast aluminium and matt opal UV-stable polyethene.
Connection: 2,5 m cable with switch and plug.
Design: Mattias Ståhlbom 2009.

ART	DESCRIPTION		PRICE/EUR
7731101	BOTTLE table/floor lamp white	IP20 18W/Gx24q-2 HF H485 D400	486,57
7731114	BOTTLE table/floor lamp yellow	IP20 18W/Gx24q-2 HF H485 D400	486,57
7731185	BOTTLE table/floor lamp alum	IP20 18W/Gx24q-2 HF H485 D400	486,57
7733101	BOTTLE table/floor lamp white	IP20 60W/E27 H485 D400	442,13
7733114	BOTTLE table/floor lamp yellow	IP20 60W/E27 H485 D400	442,13
7733185	BOTTLE table/floor alum	IP20 60W/E27 H485 D400	442,13

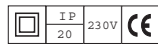

FOTO

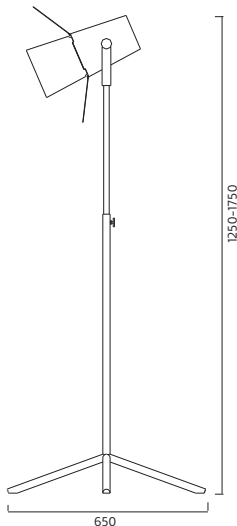

Finish: Floor lamp with adjustable spotlight. Swivelling and telescopic steam. Die-casted aluminium. HF ballast as standard.
Connection: 2,5m cable, switch and plug. Dimmer available as accessory.
Design: Thomas Bernstrand, Mattias Ståhlbom 2006.

ART	DESCRIPTION		PRICE/EUR
7649101	FOTO floorlamp white	IP20 75W/E27	802,27
7649106	FOTO floorlamp black	IP20 75W/E27	802,27
7650101	FOTO floorlamp white	IP20 26W/Gx24q-3 HF	834,79
7650106	FOTO floorlamp black	IP20 26W/Gx24q-3 HF	834,79

ACCESSORIES

97649101	Dimmer for floor fixture, whit	Only for 230V halogen	34,39
97649106	Dimmer for floor fixture, blac	Only for 230V halogen	34,39

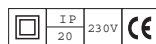
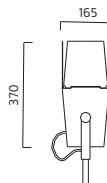

FOTO

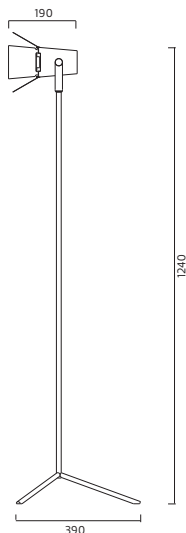

Finish: Floor lamp with adjustable spotlight. Painted steel and die-casted aluminium.

Connection: 2,5 m cable, switch and plug. Dimmer available as accessory. Black finish has black cable, other finishes have white cable.

Design: Thomas Bernstrand, Mattias Ståhlbom.

ART	DESCRIPTION		PRICE/EUR
7659101	FOTO floorlamp white	IP20 35W/GU10 H1240 mm	517,09
7659106	FOTO floorlamp black	IP20 35W/GU10 H1240 mm	517,09
7659107	FOTO floorlamp red	IP20 35W/GU10 H1240 mm	517,09
7659108	FOTO floorlamp blue	IP20 35W/GU10 H1240 mm	517,09
7659114	FOTO floorlamp yellow	IP20 35W/GU10 H1240 mm	517,09
7659141	FOTO floorlamp orange	IP20 35W/GU10 H1240 mm	517,09
7759101	FOTO floorlamp white	20W/GU5,3 12V H1240 mm	584,57
7759106	FOTO floorlamp black	20W/GU5,3 12V H1240 mm	584,57
7759107	FOTO floorlamp red	20W/GU5,3 12V H1240 mm	584,57
7759108	FOTO floorlamp blue	20W/GU5,3 12V H1240 mm	584,57
7759114	FOTO floorlamp yellow	20W/GU5,3 12V H1240 mm	584,57
7759141	FOTO floorlamp orange	20W/GU5,3 12V H1240 mm	584,57

ACCESSORIES

97649101	Dimmer for floor fixture, whit	Only for 230V halogen	34,39
97649106	Dimmer for floor fixture, blac	Only for 230V halogen	34,39

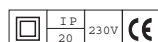

RGB

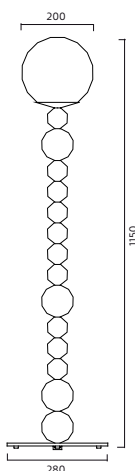

Finish: Glossy painted wooden balls. Two balls with gold leaf. Shade in opal glass. Base in black glossy painted metal.

Connection: 2,5 m cable with switch and plug.

Design: Fredrik Mattson 2008.

ART	DESCRIPTION		PRICE/EUR
7775390	RGB floor lamp	IP20 60W/E27 H1150 mm	1 746,67

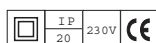

LAST

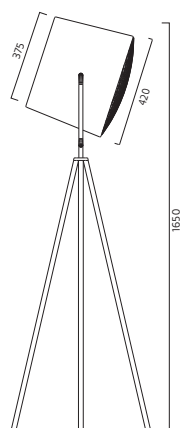

Finish: Aluminium, painted white or black. Other colours on request. Adjustable shade. Compact flourescent - with metalized reflector. Incandescent - without reflector.

Connection: 2,5 m cable, switch and plug.

Design: Mattias Ståhlbom.

ART	DESCRIPTION		PRICE/EUR
7785101	LAST floorlamp white	IP20 26-42W/Gx24q HF H1650 mm	1 053,56
7785106	LAST floorlamp black	IP20 26-42W/Gx24q HF H1650 mm	1 053,56
7786101	LAST floor lamp white	IP20 75W/E27 H1650 mm	982,50
7786106	LAST floor lamp black	IP20 75W/E27 H1650 mm	982,50



CAN



Finish: White or black enamelled aluminium and steel. With yellow inside.

Connection: 2,5 m cable with switch and plug.

Design: Mattias Ståhlbom.

ART	DESCRIPTION		PRICE/EUR
7512101	CAN floor fix. D380 white/yell	IP20 75W/E27	553,38
7512106	CAN floor fixture D380 black/y	IP20 75W/E27	553,38

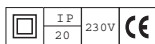

HIDE

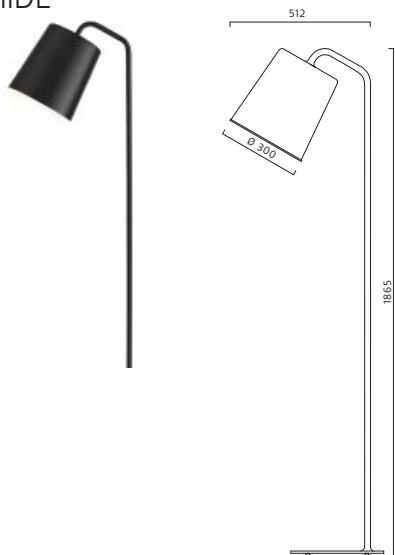

Finish: White or black-painted steel. With hidden light source behind opal acrylic diffuser, model with reflector is open. Other colors on request.

Connection: 2,5m cable with switch and plug.

Design: Thomas Bernstrand.

ART	DESCRIPTION		PRICE/EUR
7382101	HIDE floor fixture D300 white	IP20 26-42W/Gx24q HF H1865	859,92
7382106	HIDE floor fixture D300 black	IP20 26-42W/Gx24q HF H1865	871,38
7383101	HIDE floor fixture with refl.	IP20 26-42W/Gx24q HF H1865	964,18
7383106	HIDE floor fixture with refl.	IP20 26-42W/Gx24q HF H1865	975,62
7387101	HIDE floor fixture D300 white	IP20 E27/75W H1865 D300	809,97
7387106	HIDE floor fixture D300 black	IP20 E27/75W H1865 D300	809,97



HIDE

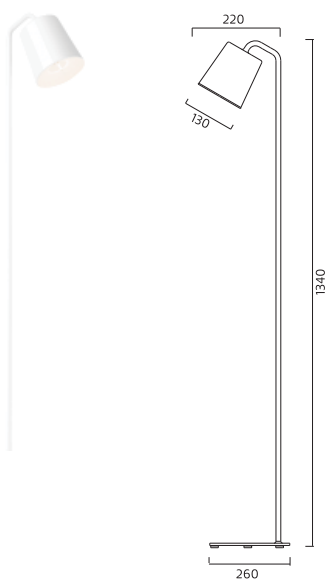

Finish: White or black-painted steel. With hidden light source behind opal acrylic diffuser.

Connection: 2,5m cable with switch and plug.

Design: Thomas Bernstrand.

ART	DESCRIPTION		PRICE/EUR
7487101	HIDE floor fixture D130 white	IP20 35W/GU10	372,39
7487106	HIDE floor fixture D130 black	IP20 35W/GU10	403,77

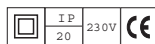

CAP

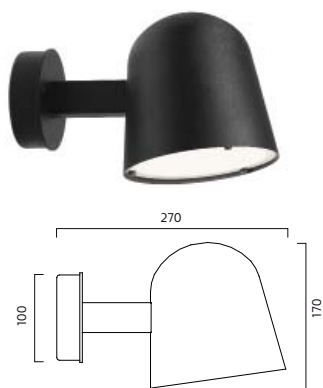

Finish: Painted steel. or galvanized steel. Matt tempered glass.

Installation: On wall.

Connection: Terminal block 3x4mm². When HFF 5x4mm².

Design: Jens Fager 2014.

ART	DESCRIPTION		PRICE/EUR
8290101	CONVEX wall/outdoor white	IP44 LED	482,04
8290106	CONVEX wall/outdoor black	IP44 LED	482,04
8290183	CONVEX wall/outdoor galv	IP44 LED	523,24

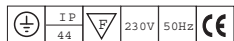

CAP

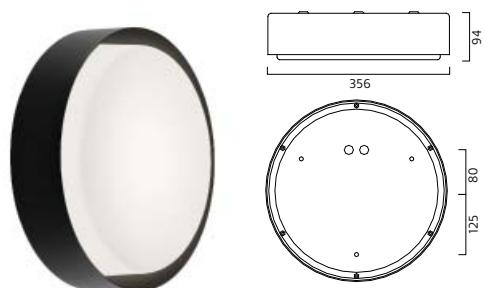

Finish: Shade in opal PMMA. Base in black painted aluminium. Other colours on request.

Installation: In ceiling or on wall.

Connection: Terminal block 5*4mm².

Design: Joel Karlsson, Krook & Tjäder Design 2013

ART	DESCRIPTION		PRICE/EUR
3305106	CAP wall opal/black	IP54 26-42W/Gx24q HF D350 mm	359,60
3305106HF-F	CAP wall black/opal D350 mm	IP54 26-42W/Gx24q Dim	425,49
3306106	CAP ceiling-wall black D350 mm	IP54 LED 15,3W/1800 lm	457,84
3306106HF-F	CAP ceiling wall black D350 mm	IP54 LED 15,3W/1800 lm Dim	540,75

HFF = Dimmable with SwitchDIM, DSI or DALI. 1-10V on request.



FISHERMAN



Finish: Shade in opal UV-stable polyethene. Handmade net in white or orange. Other colors on request.

Connection: 5 m black rubber cable with plug.

Design: Mattias Ståhlbom 2011.

ART	DESCRIPTION		PRICE/EUR
3186001	FISHERMAN pendant opal/white	IP44 E27 D300 mm	621,69
3186041	FISHERMAN pendant opal/orange	IP44 E27 D300 mm	621,69
3186101	FISHERMAN pendant opal/white	IP44 E27 D400 mm	641,84
3186141	FISHERMAN pendant opal/orange	IP44 E27 D400 mm	641,84
3186301	FISHERMAN pendant opal/white	IP44 E27 D650 mm	984,52
3186341	FISHERMAN pendant opal/orange	IP44 E27 D650 mm	984,52

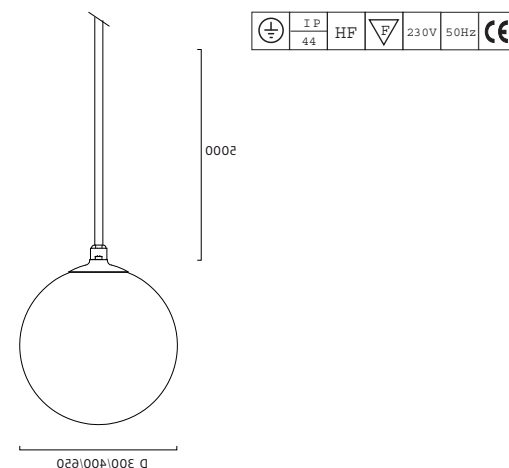

PISTILL

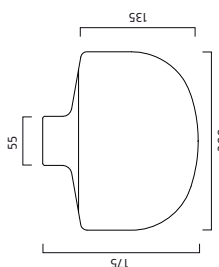

Finish: Base in painted aluminium. Matt opal UV-stable polyethene. Incl. lightsource.

Installation: Ceiling or wall.

Connection: Terminal block 3x4mm².

Design: Jens Fager 2012.

ART	DESCRIPTION		PRICE/EUR
8090101	PISTILL wall/ceiling white	IP55 10-13W/Gx24q HF D200 mm	340,12
8090141	PISTILL wall/ceiling orange	IP55 10-13W/Gx24q HF D200 mm	340,12
8090195	PISTILL wall/ceiling grey	IP55 10-13W/Gx24q HF D200 mm	340,12
8091101	PISTILL wall/ceiling white	IP55 7W/E27/Mini Twist D200 mm	310,10
8091141	PISTILL wall/ceiling orange	IP55 7W/E27/Mini Twist D200 mm	310,10
8091195	PISTILL wall/ceiling grey	IP55 7W/E27/Mini Twist D200 mm	310,10
8092101	PISTILL wall/ceiling white	IP55 LED/4 W D200 mm	323,57
8092141	PISTILL wall/ceiling orange	IP55 LED/4 W D200 mm	323,57
8092195	PISTILL wall/ceiling grey	IP55 LED/4 W D200 mm	323,57



PISTILL

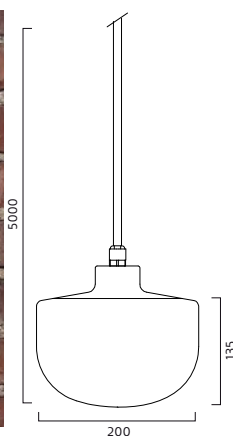

Finish: Base in painted aluminium. Matt opal UV-stable polyethene. Incl. lightsource.

Installation: 5 m rubber cable.

Connection: 5 m rubber cable with plug.

Design: Jens Fager 2012.

ART	DESCRIPTION		PRICE/EUR
8096101	PISTILL pendant opal/white	IP55 10-13W/Gx24q D200 mm	411,79
8096141	PISTILL pendant orange	IP55 10-13W/Gx24q D200 mm	411,79
8096195	PISTILL pendant opal/grey	IP55 10-13W/Gx24q D200 mm	411,79
8097101	PISTILL pendant opal/white	IP55 7W/E27/Mini Twist D200 mm	374,05
8097141	PISTILL pendant orange	IP55 7W/E27/Mini Twist D200 mm	374,05
8097195	PISTILL pendant opal/grey	IP55 7W/E27/Mini Twist D200 mm	374,05
8098101	PISTILL pendant opal/white	IP55 LED/4 W D200 mm	395,08
8098141	PISTILL pendant orange	IP55 LED/4 W D200 mm	395,08
8098195	PISTILL pendant opal/grey	IP55 LED/4 W D200 mm	395,08



RUBBER



Finish: Painted aluminium. Diffuser in Microprisma.

Installation: On wall.

Connection: Terminal block 5x4mm². Knock-out for external mains.

Design: TAF - Mattias Ståhlbom & Gabriella Gustafsson 2011.

ART	DESCRIPTION		PRICE/EUR
8172301	RUBBER wall fixtures white	IP44 26-32W/Gx24q HF B255 mm	387,55
8172301HF-F	RUBBER wall fixtures white	IP44 32W/Gx24q-3 HFF B255 mm	468,25
8172306	RUBBER wall fixtures black	IP44 26-32W/Gx24q HF B255 mm	387,55
8172306HF-F	RUBBER wall fixtures black	IP44 32W/Gx24q-3 HFF B255 mm	468,25
8172349	RUBBER wall fixtures beige	IP44 26-32W/Gx24q HF B255 mm	387,55
8172349HF-F	RUBBER wall fixtures beige	IP44 32W/Gx24q-3 HFF B255 mm	468,25
8173301	RUBBER wall fixtures white	IP44 13W/1279LM/3000K	556,55
8173306	RUBBER wall fixtures black	IP44 13W/1279LM/3000K	556,55
8173349	RUBBER wall fixtures beige	IP44 13W/1279LM/3000K	556,55

HFF = Dimmable with SwitchDIM, DSI or DALI. 1-10V on request.

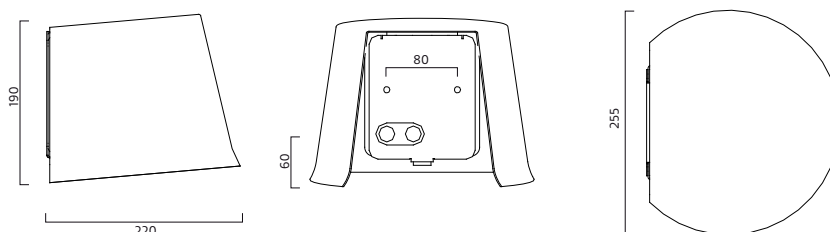

CAMOUFLAGE



Finish: Laser-cut raw aluminium. The surface is raw – one can see scratches and other marks. Can be painted in polyester color on request.
Installation: On ceiling. Wire pendant. Special lengths on request.
Connection: 3 m rubber cable without plug.
Design: Front 2007.

ART	DESCRIPTION	PRICE/EUR
7839185	CAMOUFLAGE outdoor fixture alu IP44 18W/Gx24q-2 D800 mm wire	2 838,69

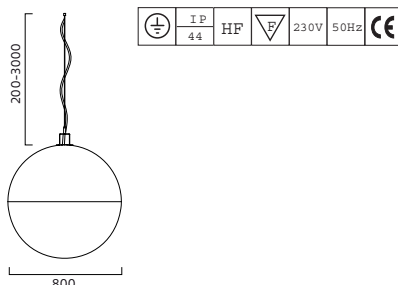

PORT



Finish: Painted aluminium and metal. Diffuser in matt acrylic. With or without figures. 2 figures on each side, more numbers on request.
Installation: Wall.
Connection: Terminal block 3x4mm². Knock-out for external mains.
Design: Krook & Tjäder Design & Anna Lund 2011.

ART	DESCRIPTION	PRICE/EUR
3340106	PORT outdoor fixtures black IP54 18W/Gx24q without numbers	400,36
3340110	PORT outdoor fixtures grey IP54 18W/Gx24q without numbers	400,36
3341106	PORT outdoor fixtures black IP54 18W/Gx24q with numbers	865,20
3341110	PORT outdoor fixtures grey IP54 18W/Gx24q with numbers	865,20

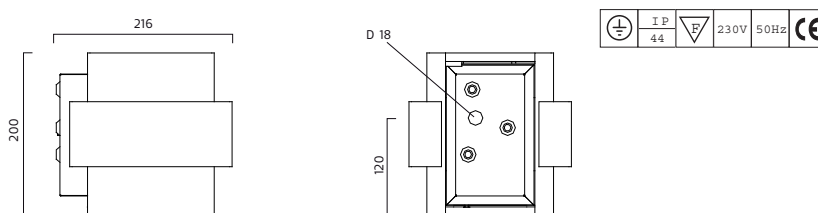

PORT

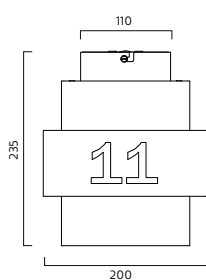
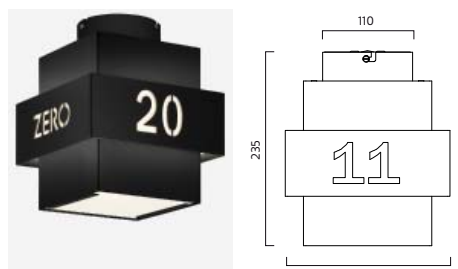

Finish: Painted aluminium and metal. Diffuser in matt acrylic. With or without figures. 2 figures on each side, more numbers on request.
Installation: Ceiling.
Connection: Terminal block 3x4mm².
Design: Krook & Tjäder Design & Anna Lund 2012.

ART	DESCRIPTION	PRICE/EUR
3342106	PORT ceiling fixture black IP44 18W/Gx24q HF no figures	450,61
3342110	PORT ceiling fixture grey IP44 18W/Gx24q HF no figures	450,61
3343106	PORT ceiling fixture black IP44 18W/Gx24q HF with figures	843,57
3343110	PORT ceiling fixture grey IP44 18W/Gx24q HF with figures	843,57

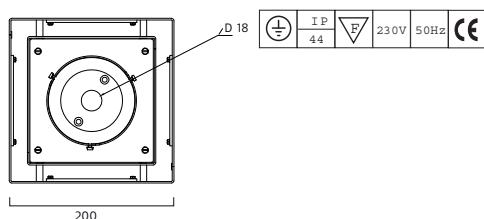

TRE



Finish: Painted die casted aluminium. Diffuser in microprisma. With downlight only or with down- and uplight.

Installation: On wall.

Connection: Terminal block 3x4mm².

Design: Thomas Sandell 2012.

ART	DESCRIPTION		PRICE/EUR
3350185	TRE wall downlight grey	IP55 9,8W/LED/3000K	527,96
3350193	TRE wall downlight brown	IP55 9,8W/LED/3000K	527,96
3351185	TRE wall downlight grey	IP55 9,8W+2,4W/LED/3000K	634,58
3351193	TRE wall downlight brown	IP55 9,8W+2,4W/LED/3000K	634,58

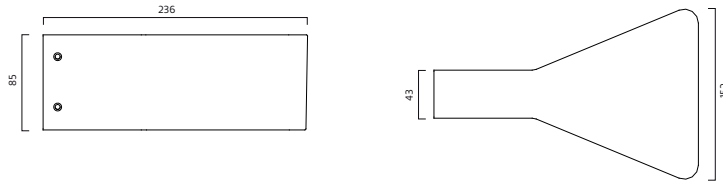

ALLRIGHT

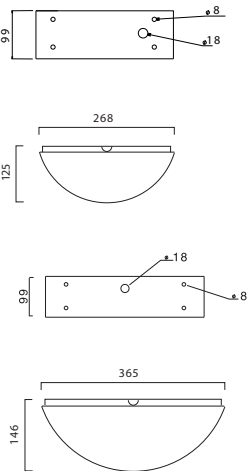

Finish: Anodized aluminium, natural, bronze or dark grey painted and white painted steel. Diffuser in prismatic acrylic.

Installation: On wall.

Connection: Snap-in terminal block 3x4mm². 7417-terminal block 5x4mm².

Design: Per Sundstedt.

ART	DESCRIPTION		PRICE/EUR
7416138	ALLRIGHT wall fixture aluminium	IP23 18W/Gx24q-2 HF B268 mm	310,94
7416197	ALLRIGHT wall fixtures bronze	IP23 18W/Gx24q-2 HF B268 mm	326,85
7416198	ALLRIGHT wall fixtures grey	IP23 18W/Gx24q-2 HF B268 mm	326,85
7416338	ALLRIGHT wall fixture alumini	IP23 2x18W/Gx24q-2 HF B365 mm	384,72
7416397	ALLRIGHT wall fixtures bronze	IP23 2x18W/Gx24q-2 HF B365 mm	400,64
7416398	ALLRIGHT wall fixtures grey	IP23 2x18W/Gx24q-2 HF B365 mm	400,64
7417338	ALLRIGHT wall fix. B365 alum	IP23 1x18W/Gx24q-2 HF w socket	391,05
7417397	ALLRIGHT wall fixtures bronze	IP23 18W/Gx24q-2 HF B365 mm	406,96
7417398	ALLRIGHT wall fixtures grey	IP23 18W/Gx24q-2 HF B365 mm	406,96
7426338	ALLRIGHT wall fixture alum	IP23 LED/1279LM/3000K B365 mm	447,17
7426397	ALLRIGHT wall fixtures bronze	IP23 LED/13W/1279LM/3000K B365	463,08
7426398	ALLRIGHT wall fixtures grey	IP23 LED/13W/1279LM/3000K B365	463,08
7427338	ALLRIGHT wall fixture alum	IP23 LED/1279LM/3000K B365 mm	510,29
7427397	ALLRIGHT wall fixtures bronze	IP23 LED/13W/1279LM/3000K B365	526,21
7427398	ALLRIGHT wall fixtures grey	IP23 LED/13W/1279LM/3000K B365	526,21

ACCESSORIES

97413101	ALLRIGHT cover B260mm	For downlight	16,79
97413301	ALLRIGHT cover B350mm	For downlight	16,79

REFLEX



Finish: Galvanized steel. A mirror is placed under the shade for extra downlight effect. A grid protects the lightsource.

Installation: Wall installation.

Connection: Terminal-block 5x4mm². Knock out for external mains cable. Two entry holes.

Design: Per Sundstedt.

ART	DESCRIPTION		PRICE/EUR
5420183	REFLEX outdoor fixture galvani	IP23 150W/E27	528,50
5423183	REFLEX outdoor fixture galvani	IP23 26-32W/Gx24q-3	615,15
5424183	REFLEX outdoor fixture gal	IP23 35W/E27 metal halide	635,12

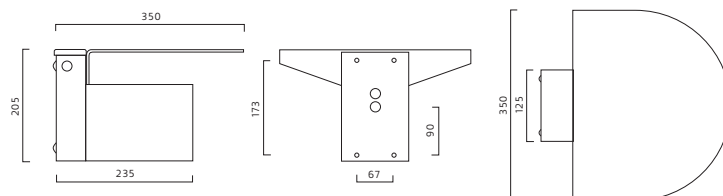

DROPPEN

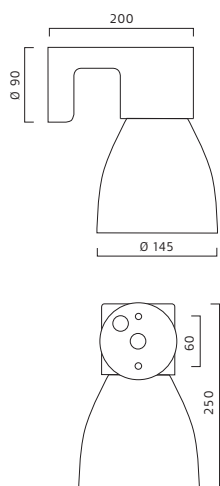

Finish: Diecasted aluminium. Shade in clear glass or matt opal glass. Incandescent models have open shade.

Installation: On wall.

Connection: Terminal block 3x4mm². Distance-piece for external mains cable available as accessory.

Design: Thomas Sandell.

ART	DESCRIPTION		PRICE/EUR
4120185	DROPPEN outdoor fixture	IP23 75W/E27 clear glass	193,79
4220185	DROPPEN outdoor fixture	IP23 75W/E27 opalglass	193,79
4221185	DROPPEN outdoor fixture	IP23 13W/Gx24q-1 opalglass	291,49
4222185	DROPPEN outdoor fixture	IP23 18W/Gx24q-2 opalglass	291,49

ACCESSORIES

94140185	DROPPEN/FELIX distance-piece	for external mains cable	29,93
----------	------------------------------	--------------------------	-------



LIGHT HOUSE

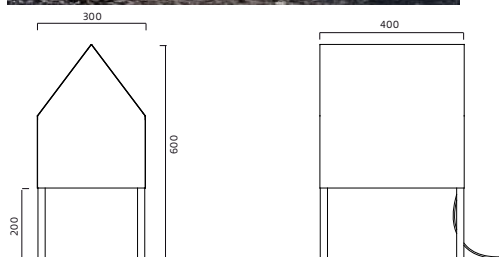

Finish: White painted metal. Diffuser in matt akrylic.

Installation: Freestanding or fixed installation. There are 4 holes, one in each end, on the ground plate.

Connection: 5 m black rubber-cable with plug. Terminal-block inside the house for fixed installation.

Design: Thomas Sandell 2009.

ART	DESCRIPTION		PRICE/EUR
7793101	LIGHT HOUSE outdoor white	IP44 18W/Gx24q-2 H600 B400/300	842,14
7794101	LIGHT HOUSE outdoor lamp white	P44 75W/E27 H600 B400/300	777,81



PXL

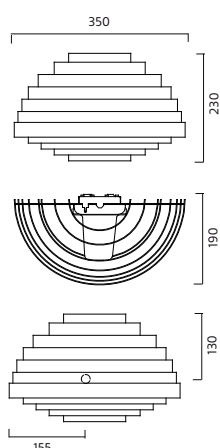

Finish: White painted metal or galvanized metal.

Installation: On Wall.

Connection: Snap-in terminal block 3x4mm². Knockout for external mains cable from above.

Design: Fredrik Mattson.

ART	DESCRIPTION		PRICE/EUR
7774101	PXL outdoor fixture white	IP44 18W/Gx24q-2 B320 mm	510,90
7774183	PXL outdoor fixture galv	IP44 18W/Gx24q-2 B320 mm	510,90



A.01

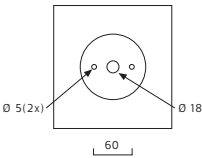
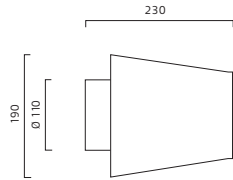
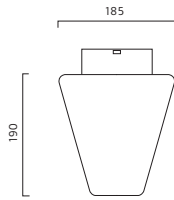

Finish: White- alt. grey painted galvanized steel. Cover in matt acrylic. Coast line model in galvanized steel

Installation: Wall installation.

Connection: Terminal-block 3x4mm². Distance-piece for external mains cable available as accessory.

Design: Kjellander + Sjöberg.

ART	DESCRIPTION		PRICE/EUR
3050101	A.01 wall fixture outdoor wh	IP44 18W/Gx24q-2 HF	373,49
3050110	A.01 wall fixture outdoor grey	IP44 18W/Gx24q-2 HF	373,49
3051101	A.01 wall fixture outdoor wh	IP44 75W/E27	322,41
3051110	A.01 wall fixture outdoor grey	IP44 75W/E27	322,41
COAST LINE MODEL			
3050183	A.01 wall fixture outdoor galv	IP44 18W/Gx24q-2 HF	389,70
3051183	.01 wall fixture outdoor galv	IP44 75W/E27	338,87
ACCESSORIES			
93040101	A.01 Distance piece white	for external mains cable	39,39
93040110	A.01 Distance piece grey	for external mains cable	39,39

BOTTLE

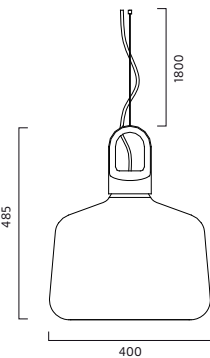

Finish: Cast aluminium and matt opal UV-stable polyethene.

Connection: 5 m black rubber-cable with plug. Pendant with 1,8 m wire.

Design: Mattias Ståhlbom 2009.

ART	DESCRIPTION		PRICE/EUR
7734101	BOTTLE pendant lamp white	IP44 60W/E27 H485 D400	531,02
7734114	BOTTLE pendant lamp yellow	IP44 60W/E27 H485 D400	531,02
7734185	BOTTLE pendant lamp aluminium	IP44 60W/E27 H485 D400	531,02
7735101	BOTTLE table/floor lamp white	IP44 60W/E27 H485 D400	502,94
7735114	BOTTLE table/floor lamp yellow	IP44 60W/E27 H485 D400	502,94
7735185	BOTTLE table/floor lamp alum	IP44 60W/E27 H485 D400	502,94



PUCK

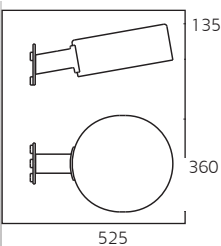

Finish: Silver grey painted steel. Reflector in aluminium. Coast line model in galvanized steel.

Cover in tempered glass.

Installation: On wall.

Connection: Terminal block 3x2,5mm². Two entry holes.



ART	DESCRIPTION		PRICE/EUR
3284110	PUCK outdoor fixture wall grey	IP44 35W/ME/E27 metalhalide	691,37
3287110	PUCK outdoor fixture wall grey	IP44 50W/SE/E27 highp. sodium	691,37
3288110	PUCK outdoor fixture wall grey	IP44 70W/ME/E27 metalhalide	691,37
3290110	PUCK outdoor fixture wall grey	IP44 70W/SE/E27 highp. sodium	691,37
3292110	PUCK outdoor fixture wall grey	IP44 42W/Gx24q-4	565,18
3293110	PUCK outdoor fixture wall grey	IP44 57W/Gx24q-5	565,18
3294110	PUCK outdoor fixture wall grey	IP44 Fortimo LED	1 098,63
COAST LINE MODEL			
3284183	PUCK outdoor fixture wall galv	IP44 35W/ME/E27 metalhalide	823,02
3287183	PUCK outdoor fixture wall galv	IP44 50W/SE/E27 highp. sodium	801,39
3371183	PUCK outdoor fixture wall galv	IP44 70W/ME/E27 metalhalide	823,02
3290183	PUCK outdoor fixture wall galv	IP44 70W/SE/E27 highp. sodium	801,39
3292183	PUCK outdoor fixture wall galv	IP44 42W/Gx24q-4	649,98
3293183	PUCK outdoor fixture wall galv	IP44 57W/Gx24q-5	668,55
3294183	PUCK outdoor fixture wall galv	IP44 Fortimo LED	1 274,96

KARO

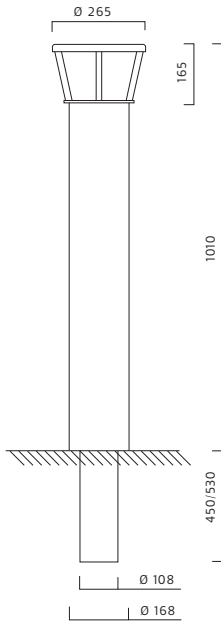

Finish: Galvanized steel or painted silvergrey or black. Cover of Polycarbonate.

Installation: Fits standard foundations 108 mm or above ground with accessory 93225-1-83.

Connection: Terminal block 5x10mm².

Design: Per Sundstedt.

Patented dynamical diffuser. Patent no. 9902727-8

ART	DESCRIPTION		PRICE/EUR
3225106	KARO bollard black H1010 mm	IP44 26-32W/Gx24q-3 HF	1 198,86
3225110	KARO bollard grey H1010 mm	IP44 26-32W/Gx24q-3 HF	1 198,86
3225183	KARO bollard galvanized H1010	IP44 26-32W/Gx24q-3 HF	1 198,86
3227106	KARO bollard black	IP44 13W/1279LM/3000K H1010	1 395,61
3227110	KARO bollard grey	IP44 13W/1279LM/3000K H1010	1 395,61
3227183	KARO bollard galvanized	IP44 13W/1279LM/3000K H1010	1 395,61

ACCESSORIES

93225106	Installationplate black	installation above ground	267,41
93225110	Installationplate silver	installation above ground	267,41
93225183	Installationplate	installation above ground	245,63



NYBRO

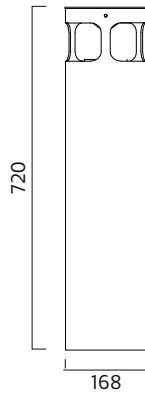

Finish: Zincd and grey painted steel or in stainless steel for installation close to coast line.

Available in two models, light in one direction (asymmetrical) and all around (symmetrical). Light accent on top standard in matt acrylic. Available in different colours on request.

Installation: Fits standard foundation D 108 mm.

Connection: Terminal block 5x10mm².

Design: Gerhard Rehm.

ART	DESCRIPTION		PRICE/EUR
3241110	NYBRO bollard H720 mm grey	IP44 CDM-T/35W G12	1 196,76
3241191	NYBRO bollard H720 stainless	IP44 CDM-T/35W G12	1 481,93
3242110	NYBRO bollard H720 mm grey	IP44 CDM-T/35W G12	1 176,52
3242191	NYBRO bollard H720 stainless	IP44 CDM-T/35W G12	1 461,69
3243110	NYBRO bollard H720 mm grey	IP44 CDM-T35W/G12 asym uplight	1 176,52
3243191	NYBRO bollard H720 stainless	IP44 CDM-T35W/G12 asym uplight	1 461,69
3244110	NYBRO bollard H720 mm grey	IP44 CDM-T35W/G12 sym uplight	1 176,52
3244191	NYBRO bollard H720 stainless	IP44 CDM-T35W/G12 sym uplight	1 461,69
3246110	NYBRO bollard H720 mm grey	IP44 LED/2000Lm/840	1 638,81
3246191	NYBRO bollard H720 stainless	IP44 LED/2000Lm/840	1 863,83
3247110	NYBRO bollard H720 mm grey	IP44 LED/2000Lm/840	1 657,34
3247191	NYBRO bollard H720 stainless	IP44 LED/2000Lm/840	1 941,81



POKER



Finish: Black or grey painted metal/aluminium. Diffuser in matt acrylic.

Installation: Fits pole diameter 60 mm.

Connection: Terminal block 4x10mm².

Design: Thomas Bernstrand 2012.

ART	DESCRIPTION		PRICE/EUR
3360301	POKER pole fixture white	IP44 2x26-42W/Gx24q HF D1040	1 901,13
3360306	POKER pole fixture black	IP44 2x26-42W/Gx24q HF D1040	1 901,13
3360310	POKER pole fixture grey	IP44 2x26-42W/Gx24q HF D1040	1 901,13
3361301	POKER pole fixture white	IP44 LED D1040 mm	2 384,68
3361301HF-F	POKER pole/floor fixture white	IP44 LED D1040 mm HF-F	2 468,52
3361306	POKER pole fixture black	IP44 LED D1040 mm	2 384,68
3361306HF-F	POKER pole/floor fixture black	IP44 LED D1040 mm HF-F	2 468,52
3361310	POKER pole fixture grey	IP44 LED D1040 mm	2 384,68
3361310HF-F	POKER pole/floor fixture grey	IP44 LED D1040 mm HF-F	2 468,52
ACCESSORIES			
93230106	Black painted pole 3-4m D60		655,41
93230110	Grey painted pole 3-4000mm	7772140 C40 RAL9006	770,99
93230183	Pole 3-4m D60mm galvanized		483,80

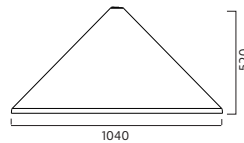

CONE



Finish: Black or grey painted metal/aluminium. Diffuser in tempered glass.

Installation: On standard pole diameter 60 mm 3000 - 4000 mm above ground.

Connection: Terminal block 4x10mm².

Design: Propeller

ART	DESCRIPTION		PRICE/EUR
3321306	CONE pole fixtures black	IP44 35W/E27/ME	1 107,42
3321310	CONE pole fixtures grey	IP44 35W/E27/ME	1 107,42
3322306	CONE pole fixtures black	IP44 70W/E27/ME	1 107,42
3322310	CONE pole fixtures grey	IP44 70W/E27/ME	1 107,42
3323306	CONE pole fixtures black	IP44 42W/Gx24q-4	1 107,42
3323310	CONE pole fixtures grey	IP44 42W/Gx24q-4	1 107,42
3324306	CONE pole fixtures black	IP44 50W/E27/SE	1 107,42
3324310	CONE pole fixtures grey	IP44 50W/E27/SE	1 107,42
3325306	CONE pole fixtures black	IP44 70W/E27/SE	1 107,42
3325310	CONE pole fixtures grey	IP44 70W/E27/SE	1 107,42
3326306	CONE pole fixtures black	IP54 LED 20W/1800lm/3000K	1 292,67
3326310	CONE pole fixtures grey	IP54 LED 20W/1800lm/3000K	1 292,67
9331106	CONE top tube black		46,79
9331110	CONE top tube grey		46,79
9331183	CONE top tube galvanized		46,79
ACCESSORIES			
93230106	Black painted pole 3-4m D60		655,41
93230110	Grey painted pole 3-4000mm	7772140 C40 RAL9006	770,99
93230183	Pole 3-4m D60mm galvanized		483,80



COLONN

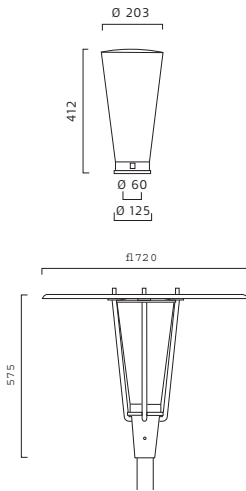

Finish: Grey or black painted aluminium. Shade in polycarbonat. Upper shade available as accessory.

Installation: On standard pole diameter 60 mm 3-4 m above ground.

Connection: Terminal block 4x10mm².

Design: Per Sundstedt.

With patented dynamical reflector. Patent no. 9902727-8

ART	DESCRIPTION		PRICE/EUR
3248106	COLONN post fixture black	IP44 35W/ME/E27	860,11
3248110	COLONN post fixture grey	IP44 35W/ME/E27	860,11
3252106	COLONN post fixture black	IP44 70W/ME/E27	860,11
3252110	COLONN post fixture grey	IP44 70W/ME/E27	860,11
3253106	COLONN post fixture black	IP 44 70W/SE/E27	860,11
3253110	COLONN post fixture grey	IP44 70W/SE/E27	860,11
3254106	COLONN post fixture black	IP44 57W/Gx24q-5	752,58
3254110	COLONN post fixture grey	IP44 57W/Gx24q-5	752,58
3276110	COLONN pole fixtures grey	IP44 25W/2000lm/3000K H412	1 055,91

ACCESSORIES

93257106	COLONN symmetricale shade black		438,68
93257110	COLONN symmetricale shade grey		430,05
93230106	Black painted pole 3-4m D60		655,41
93230110	Grey painted pole 3-4000mm	7772140 C40 RAL9006	770,99
93230183	Pole 3-4m D60mm galvanized		483,80



BERZELI

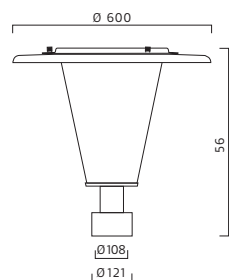

Lampstandard with dynamic reflector which refracts the light away from critical dazzle glare angles with great precision. You have to be in the immediate vicinity of the lampshade to see it fully illuminated. At a distance, the lampshade only gives a gentle light and thus indicates its position.

Finish: Black or grey painted aluminium. Shade in acrylic.

Installation: On standard pole D108 mm, 3000-4000 mm above ground.

Connection: Terminal block 4x10mm².

Design: Per Sundstedt

With patented dynamical diffuser. Patent no. 9902727-8

ART	DESCRIPTION		PRICE/EUR
3212106	BERZELI pole fixture black	IP44 35W/ME/E27 Metal halide	1 505,18
3212110	BERZELI pole fixture black	IP44 35W/ME/E27 Metal halide	1 505,18
3214106	BERZELI post fixture black	IP44 70W/SE/E27 HF	1 630,42
3216106	BERZELI post fixture black	IP44 57W/Gx24q-5	1 397,70
3216110	BERZELI post fixture grey	IP44 57W/Gx24q-5	1 397,70
3217106	BERZELI pole fixture black	IP44 70W/ME/E27	1 505,18
3217110	BERZELI post fixture grey	IP44 70W/ME/E27	1 505,18
3218106	BERZELI post fixture black	IP44 70W/SE/E27	1 505,20
3218110	BERZELI post fixture grey	IP44 70W/SE/E27	1 505,20

ACCESSORIES

93210106	Pole black 3-4000 mm	D108 mm	1 183,86
93210110	Pole grey 3-4000 mm	D 108 mm	1 315,95



OUTDOOR FIXTURES/POLE FIXTURES

PUCK

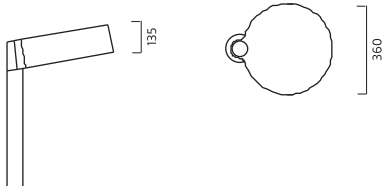

Finish: Silver grey painted steel. Reflector in aluminium. Cover of tempered glass. Coast line model in galvanized steel.

Installation: Fits pole diameter 60 mm

Connection: Terminal block 4x10mm².

Design: R. Aosta.

ART	DESCRIPTION		PRICE/EUR
3278110	PUCKE pole fixtures grey	IP44 Fortimo LED 3000lm	1 091,05
3280110	PUCK post fixture grey	IP44 50W/SE/E27 highp. sodium	572,65
3281110	PUCK post fixture grey	IP44 70W/ME/E27 metal halide	572,65
3283110	PUCK post fixture grey	IP44 70W/SE/E27 highp. sodium	572,65
3285110	PUCK pole fixture grey	IP44 42W/Gx24q-4	454,23
3286110	PUCK post fixture grey	IP44 57W/Gx24q-5	468,44
3289110	PUCK post fixture grey	IP44 35W/ME/E27 metal halide	572,65
COAST LINE MODEL			
3278183	PUCK pole fixtures galv	IP44 Fortimo LED 3000lm	1 206,42
3280183	PUCK post fixture galv	IP44 50W/SE/E27 highp. sodium	740,11
3370183	PUCK post fixture galv	IP44 70W/ME/E27 metal halide	754,89
3283183	PUCK post fixture galv	IP44 70W/SE/E27 highp. sodium	740,11
3285183	PUCK pole fixture galv	IP44 42W/Gx24q-4	581,85
3286183	PUCK post fixture galv	IP44 57W/Gx24q-5	600,78
3289183	PUCK post fixture galv	IP44 35W/ME/E27 metal halide	754,89
ACCESSORIES			
93230110	Grey painted pole 3-4000mm	7772140 C40 RAL9006	770,99
93230183	Pole 3-4m D60mm galvanized		483,80

PUCK

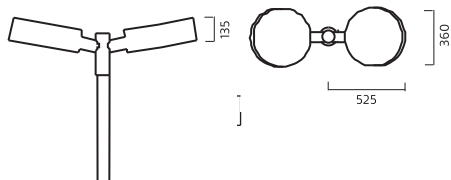

Finish: Silver grey painted steel. Reflector in aluminium. Cover of tempered glass.

Installation: Fits pole diameter 60 mm

Connection: Terminal block 4x10mm².

Design: R. Aosta.

ART	DESCRIPTION		PRICE/EUR
3278310	THREE PUCK pole fixtures grey	IP44 Fortimo 3XLED 3000lm	3 351,21
3280310	TREPUCK post fixture grey	IP44 3x50W/SE/E27 highp.sodium	1 815,05
3281310	TREPUCK post fixture grey	IP44 3x70W/ME/E27 metal halide	1 815,05
3283310	TREPUCK pole fixtures grey	IP44 3x70W/SE/E27 highp.sodium	1 815,05
3285310	TREPUCK post fixture grey	IP44 3x42W/Gx24q-4	1 792,65
3286310	TREPUCK post fixture grey	IP44 3x57W/Gx24q-5	1 792,65
3289310	TREPUCK post fixture grey	IP44 3x35W/ME/E27 metal halide	1 815,05
COAST LINE MODEL			
3278283	TWO PUCK pole fixtures grey	IP44 Fortimo 2XLED 3000lm	2 495,93
3280283	TVÄPUCK post fixture grey	IP44 2x50W/SE/E27 highp.sodium	1 545,82
3370283	TVÄPUCK post fixture grey	IP44 2x70W/ME/E27 metal halide	1 575,39
3283283	TVÄPUCK post fixture grey	IP44 2x70W/SE/E27 highp.sodium	1 545,82
3285283	TVÄPUCK post fixture grey	IP44 2x42W/Gx24q-4	1 229,31
3286283	TVÄPUCK post fixture grey	IP44 2x57W/Gx24q-5	1 266,44
3289283	TVÄPUCK post fixture grey	IP44 2x35W/ME/E27 metal halide	1 575,39
ACCESSORIES			
93230110	Grey painted pole 3-4000mm	7772140 C40 RAL9006	770,99
93230183	Pole 3-4m D60mm galvanized		483,80

PUCK

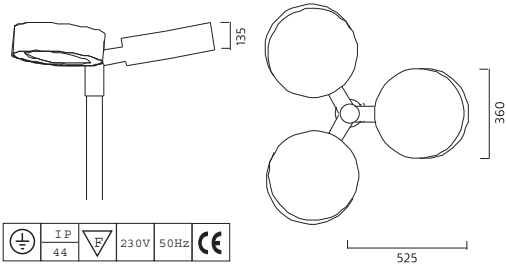

Finish: Silver grey painted steel. Reflector in aluminium. Cover of tempered glass. Coast line model in galvanized steel.

Installation: Fits pole diameter 60 mm

Connection: Terminal block 4x10mm².

Design: R. Aosta.

ART	DESCRIPTION		PRICE/EUR
3278310	THREE PUCK pole fixtures grey	IP44 Fortimo 3XLED 3000lm	3 351,21
3280310	TREPUCK post fixture grey	IP44 3x50W/SE/E27 highp.sodium	1 815,05
3281310	TREPUCK post fixture grey	IP44 3x70W/ME/E27 metal halide	1 815,05
3283310	TREPUCK pole fixtures grey	IP44 3x70W/SE/E27 highp.sodium	1 815,05
3285310	TREPUCK post fixture grey	IP44 3x42W/Gx24q-4	1 792,65
3286310	TREPUCK post fixture grey	IP44 3x57W/Gx24q-5	1 792,65
3289310	TREPUCK post fixture grey	IP44 3x35W/ME/E27 metal halide	1 815,05
COAST LINE MODEL			
3278383	THREE PUCK pole fixtures galv	IP44 Fortimo 3XLED 3000lm	3 727,93
3280383	TREPUCK post fixture galv	IP44 3x50W/SE/E27 highp.sodium	2 299,81
3370383	TREPUCK post fixture galv	IP44 3x70W/ME/E27 metal halide	2 344,33
3283383	TREPUCK pole fixtures galv	IP44 3x70W/SE/E27 highp.sodium	2 299,81
3285383	TREPUCK post fixture galv	IP44 3x42W/Gx24q-4	1 824,85
3286383	TREPUCK post fixture galv	IP44 3x57W/Gx24q-5	1 881,09
3289383	TREPUCK post fixture galv	IP44 3x35W/ME/E27 metal halide	2 344,33
ACCESSORIES			
93230110	Grey painted pole 3-4000mm	7772140 C40 RAL9006	770,99
93230183	Pole 3-4m D60mm galvanized		483,80

RIB

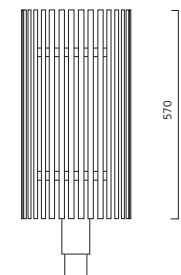
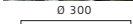
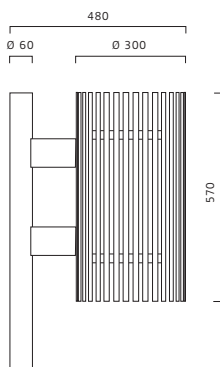
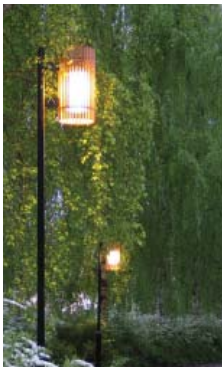

Finish: Grey- or black-painted steel. Shade in teak with opal diffuser.

Installation: Fits pole diameter 60 mm. Pole available as accessory.

Connection: Terminal block 4x10mm².

Design: Niklas Ödmann, Ljusarkitektur.

ART	DESCRIPTION		PRICE/EUR
3210106	RIB post fixture w arm teak	IP44 26-42W/Gx24q HF	1 515,30
3210110	RIB post fixture w arm teak	IP44 26-42W/Gx24q HF	1 515,30
3211106	RIB post fixture c-hold teak/b	IP44 26-42W/Gx24q HF	1 515,30
3211110	RIB post fixture c-hold teak	IP44 26-42W/Gx24q HF	1 515,30
ACCESSORIES			
93230106	Black painted pole 3-4m D60		655,41
93230110	Grey painted pole 3-4000mm	7772140 C40 RAL9006	770,99
93230183	Pole 3-4m D60mm galvanized		483,80



W-BELL

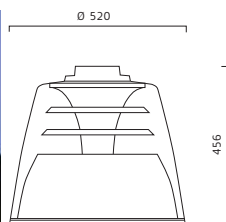

Finish: Silver-grey painted steel. Shade in clear acrylic. Reflector in aluminium.

Installation: Fits standard pole D 60 mm or on wire.

Connection: Terminal block 4x10mm².

Design: Wingårdhs Arkitekter.

ART	DESCRIPTION		PRICE/EUR
3260310	W-BELL post fixture fitting	IP44 70W/ME/E27	1 264,86
3261310	W-BELL post fixture fitting	IP44 150W/ME/E27	1 285,93
3262310	W-BELL post fixture fitting	IP44 70W/SE/E27	1 259,60
3263310	W-BELL post fixture fitting	IP44 150W/SE/E40	1 278,15
3264310	W-BELL post fixture fitting	IP44 57W/Gx24q-5	1 246,52
3270310	W-BELL post fixture fitting	IP44 70W/ME/E27 HF	1 324,09

ACCESSORIES

93230110	Grey painted pole 3-4000mm	7772140 C40 RAL9006	770,99
93230183	Pole 3-4m D60mm galvanized		483,80
93260110	Arm fitting for pole D 60mm	Grey RAL 9006	224,83
93261110	Wire fitting		260,66

LINK

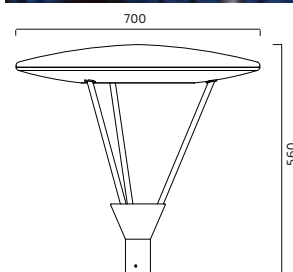

Finish: Grey painted metal. Diffuser in tempered glass.

Installation: On standard pole diameter 60 mm 3000 - 4000 mm above ground. Available as wall fixture on request.

Connection: Terminal block 4x10mm².

Design: Helena Björnberg.

ART	DESCRIPTION		PRICE/EUR
3310110	LINK pole fixtures	IP44 35W/ME/E27	1 513,61
3311110	LINK pole fixtures	IP44 70W/ME/E27	1 513,61
3312110	LINK pole fixtures	IP44 42W/Gx24q	1 420,04

ACCESSORIES

93230110	Grey painted pole 3-4000mm	7772140 C40 RAL9006	770,99
93230183	Pole 3-4m D60mm galvanized		483,80



Eikelenboom
 Crugiusweg 111 L
 1019 AB Amsterdam
 Tel: 020 6918161
 Fax: 020 6915411
 info@eikelenboom.nl
 www.eikelenboom.nl

Zero, Box 800, 382 28 Nybro, Sweden
 Tel: +46 (0) 481 800 00
 info@zero.se www.zero.se

