

Chipperfield w102

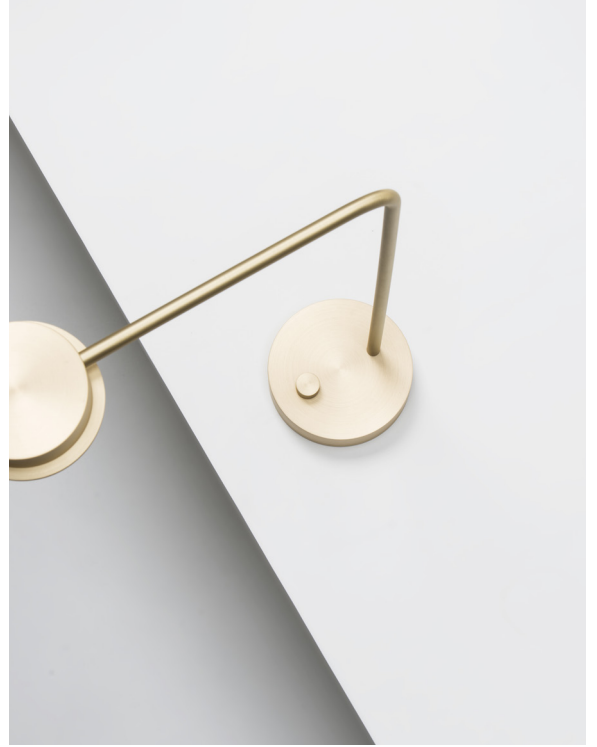

DETAILS

TECHNICAL INFORMATION:

Light source: 4 W LED
Light source included
Colour temperature: 3.000 K
CRI: > 90
Lumen: 275
Lumen / W: 69
LED Life-time: 50.000 h

MATERIAL:

Chipperfield w102 is made of solid brass. The base is punched and the shade is spun. The parts are brushed and treated with a clear matt lacquer.

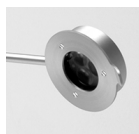
WARM WHITE LED:

The light technology is based on an energy-efficient, high quality, LED solution which gives warm white light.

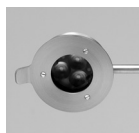
OPTICAL LENSES:

Optical lenses gives good light distribution and glare-protection.

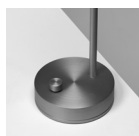
BALL BEARING CONSTRUCTION:

A ball bearing construction enables smooth rotation between the upper and lower base parts.

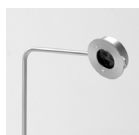
ADJUSTABLE SHADE:

The shade can be adjusted 140 degrees (+/- 70 degrees) around its horizontal axis.

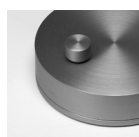
DIMMER BUTTON:

The integrated dimmable LED driver is operated by a dimmer button made of solid brass.

PACKAGING:

Chipperfield w102

Weight: 4 kg
Length: 58 cm
Width: 34 cm
Height: 17 cm
Volume: 0,033 m³

COLOUR:

brass

MODELS



TABLE LAMP

Chipperfield w102

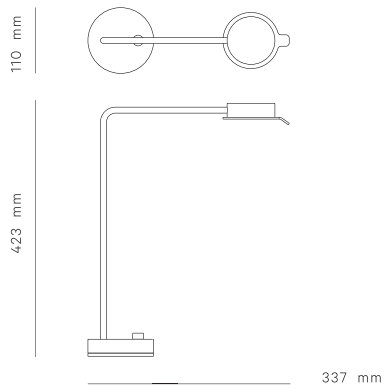

ARTICLE NO.

102T100 Colour: brass